

ROTHENBERGER
pipetool technologies at work



MAIN CATALOG 2022



Cordless Alliance System:

One battery, many solutions.



ROTHENBERGER is part of it!

Discover cordless freedom! Profit from **100% compatibility** of machines, battery packs and chargers in one cross-manufacturer system! With CAS the **world's most powerful battery pack system** in the industry from Metabo and more than **30 years of battery pack competency** are now available for ROTHENBERGER machines. How do you benefit from it? **Maximum reliability**, clear **cost advantages** and **high investment reliability**.

More information can be found at www.cordless-alliance-system.com

Welcome to ROTHENBERGER!

We at ROTHENBERGER are driven by the needs of plumbers, service technicians and installers. We develop pipe tools and machines that assist craftspeople, to ensure construction sites are always under control.

To achieve this, we see the world through your eyes, familiarise ourselves closely with your everyday work and listen to you if you provide us with suggestions or criticism. In addition, all of our new products undergo an on-site endurance test. Only if they pass this test do they make it to the market.

If you are able to complete your work cleanly, quickly, easily and profitably, and go home happy, then we have done a good job.





Focus on users

ROTHENBERGER was founded as a trading house in 1949. As early as 1967 ROTHENBERGER has developed the first system solution, the **R-System**. It consisted of tools for expanding, extracting and bending pipes – revolutionary equipment enabling installers to connect pipes without fittings, significantly speeding up the installation process.

Today, ROTHENBERGER serves installers and ACR technicians worldwide with products which have been co-developed, tested and improved by professional users.



Solutions for professionals: systems that fit.

Our system solutions extend beyond tools:
Transport and store equipment and machines in
the **ROCASE** system. Re-use our **ROBOX** packaging
as containers for consumables in the **ROCASE**.
Use our **CAS**¹⁾ batteries to operate more than 280
compatible machines.



100% COMPATIBLE

Service for professionals: always prepared.

The **RO SERVICE+** takes care of
maintenance and repairs: Our Service
After Sales team quickly gets equipment
back up and running without any detours,
because we have your tool collected
where you are and also deliver it to you
at the construction site, upon request.²⁾



¹⁾ More information at cordless-alliance-system.com

²⁾ Complete terms and conditions at rothenberger.com/roservice
RO SERVICE+ only valid in participating countries



We are here for you.

You can reach us through many channels – the website [rothenberger.com](https://www.rothenberger.com), by email at info@rothenberger.com, by phone on our customer hotline and on our technical customer service hotline.



Visit us on Facebook, Instagram and YouTube!



Installation	Cutting		8	1
	RODIA Diamond Core Drilling		36	2
	Bending		54	3
	Expanding, Extracting, Flaring		78	4
	Pressing		100	5
	Threading & Grooving		124	6
	Soldering & Welding		148	7
Service & Maintenance	Testing & Leak Detection		182	8
	Freezing		194	9
	Inspection & Locating		202	10
	Flushing & Pipe Cleaning		216	11
ROWELD Plastic Pipe Welding		252	12	
Refrigeration & Air-Conditioning Technology		274	13	
General-Purpose Tools		296	14	
Index – Alphabetical / Numeric, Legend – Abbreviations / Pictograms			338	15



*Detailed guarantee terms at <https://rothenberger.com/gb-en/5-year-replacement-warranty>
(Only in participating countries)



Cutting

System overview	10 - 13
Cutting metal, manual	
Tube cutter for copper and steel	14 - 18
Tube cutter for stainless steel (INOX) and steel	18 - 20
Cutting wheels and spare parts	21
Cutting plastic / MLP, manual	
Plastic pipe shears	22 - 24
Tube cutter for plastic	25 - 27
Tube cutter for MLP	28
Sawing, manual	
Hand saws and saw blades	29
Sawing, electric	
Cordless combi-pipe saw	30 - 31
Deburring, chamfering and calibration	
Universal internal and external deburrer	32 - 33
Deburrer for metal	34
Chamfering unit for plastic	35



Cutting

System overview

1

Pipe cutters for metal, plastic, MLP

	 <p>TC 35 DURAMAG</p>	 <p>TC 35 DURAMAG MLP</p>	 <p>TC 35 PRO INOX DURAMAG</p>	 <p>TC 42 PRO</p>	
Working range:	Ø 6-35 mm (1/4-1.3/8")	Ø 6-35 mm (1/4-1.3/8")	Ø 6-35 mm (1/4-1.3/8")	Ø 6-42 mm (1/4-1.5/8")	
Dimensions:	150 x 60 x 40 mm	150 x 60 x 40 mm	150 x 60 x 40 mm	160 x 60 x 40 mm	
Weight:	255 g	255 g	255 g	550 g	
Extras:	Internal pipe deburrer, spare cutter wheel	Internal pipe deburrer, spare cutter wheel	Internal pipe deburrer, spare cutter wheel	Internal pipe deburrer, spare cutter wheel	
Suitable for:	Cu, brass, Al, thin-walled steel pipes	PE-, PP-, PVDF-, PVC, plastic-coated pipes	Stainless steel	Cu, brass, Al, thin-walled steel pipes	
Page	14 - 15	28	14 - 15	14 - 15	
	 <p>TC 42 XL</p>	 <p>TC 42 PRO MLP</p>	 <p>TC 42 PRO PVC</p>	 <p>TC 42 PRO INOX</p>	 <p>TC CSST</p>
Working range:	Ø 6-42 mm (1/4-1.5/8")	Ø 6-42 mm (1/4-1.5/8")	Ø 6-42 mm (1/4-1.5/8")	Ø 6-42 mm (1/4-1.5/8")	Ø 10-42 mm (3/8"-1.5/8")
Dimensions:	166 x 67 x 54 mm	160 x 60 x 40 mm	160 x 60 x 40 mm	160 x 60 x 40 mm	166 x 67 x 54 mm
Weight:	430 g	550 g	550 g	550 g	430 g
Extras:	Internal pipe deburrer, spare cutter wheel	Internal pipe deburrer, spare cutter wheel	Internal pipe deburrer, spare cutter wheel	Internal pipe deburrer, spare cutter wheel	Spare cutter wheel
Suitable for:	Cu, brass, Al, thin-walled steel pipes	PE, PP, PVDF, plastic-coated pipes	PE, PP, PVDF, plastic-coated pipes	Stainless steel	Corrugated INOX pipes up to 0.2 mm
Page	15	28	28	19	19
	 <p>MINICUT I PRO</p>	 <p>MINICUT II PRO</p>	 <p>MINICUT 2000 30 PRO</p>	 <p>MINI MAX 50</p>	 <p>TUBE CUTTER 30 PRO</p>
Working range:	Ø 3-16 mm (1/8-5/8")	Ø 6-22 mm (1/4-7/8")	Ø 3-22 mm (1/8-7/8")	Ø 3-28 mm (1/8-1.1/8")	Ø 3-30 mm (1/8-1.3/8")
Dimensions:	46 x 35 x 22 mm	55 x 38 x 22 mm	70 x 40 x 30 mm	80 x 60 x 30 mm	150 x 60 x 28 mm
Weight:	110 g	125 g	140 g	270 g	305 g
Extras:	Spare cutter wheel, spare axle	Spare cutter wheel, spare axle	Spare cutter wheel, spare axle	Spare cutter wheel, spare cutter wheel	Internal pipe deburrer, spare cutter wheel
Suitable for:	Cu, brass, Al, thin-walled steel pipes	Cu, brass, Al, thin-walled steel pipes	Cu, brass, Al, thin-walled steel pipes	Cu, brass, Al, thin-walled steel pipes	Cu, brass, Al, thin-walled steel pipes
Page	16	16	16	16	17

Pipe cutters for metal

	TUBE CUTTER 50	TUBE CUTTER 30 PRO INOX	Automatic pipe cutter size 1	Automatic pipe cutter size 2	Chain pipe cutter
Working range:	Ø 12-50 mm (1/2-2")	Ø 3-30 mm (1/8-1.1/8")	Ø 6-67 mm (1/4-2.5/8")	Ø 50-127 mm (2-5")	Ø 20-100 mm (1-4")
Dimensions:	175 x 75 x 30 mm	150 x 60 x 28 mm	240 x 110 x 50 mm	360 x 80 x 70 mm	370 x 280 x 250 mm
Weight:	520 g	305 g	755 g	755 g	575 g
Extras:	Internal pipe deburrer, spare cutter wheel	Internal pipe deburrer, spare cutter wheel	Internal pipe deburrer, spare cutter wheel	Internal pipe deburrer	-
Suitable for:	Cu, brass, Al, thin-walled steel pipes	Stainless steel, thin-walled steel pipes	Cu, brass, Al, thin-walled steel pipes, plastic-coated pipes	Cu, brass, Al, thin-walled steel pipes, plastic-coated pipes	Cu, brass, Al, thin-walled steel pipes, plastic-coated pipes

Page

17

18

17

17

17

	ROSLICE 12 mm	ROSLICE 15 mm	ROSLICE 18 mm	ROSLICE 22 mm	TUBE CUTTER INOX
Working range:	Ø 12 mm (1/2")	Ø 15 mm (5/8")	Ø 18 mm (3/4")	Ø 22 mm (7/8")	Ø 6-60 mm (1/4-2.3/8")
Dimensions:	48 x 48 x 35 mm	48 x 48 x 35 mm	58 x 58 x 35 mm	58 x 58 x 35 mm	230 x 110 x 40 mm
Weight:	230 g	240 g	250 g	260 g	780 g
Extras:	-	-	-	-	-
Suitable for:	Cu	Cu	Cu	Cu	Stainless steel

Page

18

18

18

18

19

	ENORM 4"	SUPER 1.1/4"	SUPER 2"	SUPER 1.1/4" INOX	SUPER 2" INOX
Working range:	Ø 60-115 mm (2-4")	Ø 10-42 mm (1/8-1.1/4")	Ø 10-60 mm (1/8-2")	Ø 10-42 mm (3/8-1.1/4")	Ø 10-60 mm (3/8-2")
Dimensions:	600 x 175 x 55 mm	270 x 80 x 35 mm	370 x 100 x 55 mm	280 x 110 x 40 mm	370 x 100 x 55 mm
Weight:	7,105 g	1,040 g	2,155 g	1,040 g	2,155 g
Extras:	-	-	-	-	-
Suitable for:	Steel	Steel	Steel	Stainless steel	Stainless steel

Page

20

20

20

20





20



Cutting

System overview



1

Plastic shears




	ROCUT TC 26	ROCUT TC 32	ROCUT PS 35	ROCUT PS 26/42 S
				
Working range:	Ø 0-26 mm (0-1")	Ø 0-32 mm (0-1.1/4")	Ø 6-35 mm (1/4-1.3/8")	Ø 6-42 mm (1/4-1.5/8")
Dimensions:	190 x 80 x 30 mm	210 x 60 x 30 mm	215 x 195 x 40 mm	290 x 240 x 40 mm
Weight:	370 g	220 g	740 g	950 g
Suitable for:	PP, PE, PEX, PB, PVDF, MLP	PP, PE, PEX, PB, PVDF, MLP	PP, PE, PEX, PB, PVDF, MLP	PP, PE, PEX, PB, PVDF, MLP
Page	22, 24	22, 24	22, 24	22, 24

	ROCUT TC 42	ROCUT TC 42 Twin Cut	ROCUT TC 50	ROCUT TC 63	ROCUT TC 75
					
Working range:	Ø 0-42 mm (0-1.5/8")	Ø 0-20 / 20-42 mm	Ø 0-50 mm (0-2")	Ø 0-63 mm (0-2.1/2")	Ø 0-75 mm (0-3")
Dimensions:	210 x 100 x 25 mm	235 x 105 x 20 mm	260 x 120 x 25 mm	280 x 130 x 30 mm	480 x 165 x 35 mm
Weight:	447 g	550 g	600 g	700 g	1,740 g
Suitable for:	PP, PE, PEX, PB, PVDF, MLP	PP, PE, PEX, PB, PVDF	PP, PE, PEX, PB, PVDF, MLP	PP, PE, PEX, PB, PVDF, MLP	PP, PE, PEX, PB, PVDF, MLP
Page	22, 24	23	22, 24	22, 24	22, 24

Cutting

	ROCUT 110	ROCUT 160
		
Suited for:	PE, PP, PVC, PEX, PVDF, PB**	PE, PP, PVC, PEX, PVDF, PB**
Outer pipe diameter:	Ø 32 - 110 mm	Ø 110 - 160 mm
Wall thickness:	Up to max. 16 mm*	Up to max. 16 mm*
Operation mode:	Manual	Manual
Function:	Cutting, chamfering	Cutting, chamfering
Page	25 - 26	25 - 26

Plastic pipe cutters

	TC 67 PL	TC 125 PL	TC 168 PL
			
Working range:	Ø 6-67 mm (1/4-2.5/8")	Ø 50-125 mm (2-5")	Ø 110-168 mm (4.3/8-6.5/8")
Dimensions:	230 x 110 x 40 mm	360 x 180 x 50 mm	390 x 220 x 50 mm
Weight:	700 g	1,600 g	1,700 g
Extras:	Internal pipe deburrer, spare cutter wheel	Internal pipe deburrer	Internal pipe deburrer
Suitable for:	PE, PP, PEX, PB, PVDF-pipes, sound-isolated drain pipes	PE, PP, PEX, PB, PVDF-pipes, sound-isolated drain pipes	PE, PP, PEX, PB, PVDF-pipes, sound-isolated drain pipes

Page **27** **27** **27**

Pipe saws



Working range:	< Ø110 mm
Suitable for:	Copper, plastic, C-steel, cast iron or stainless steel, mounting rails, threaded bolts, aluminium cover plates, wood, panels
Power:	18V CAS battery system
Speed:	4150 rpm / 28-30 m/s
Weight:	4.3 kg (without battery)
Dimensions:	330 x 246 x 258 mm
Saw blade clamp:	Ø 20 mm
Modular system:	Pipe saw, circular saw, plunge saw, cross-cutting saw

Page **30**

Cutting

Cutting metal, manual

1 TUBE CUTTER 35 / 42 Pro

Proven pipe cutter for the precise cutting of pipes
 Ø 6 - 42 mm (1/4 - 1.5/8")



Product profile

APPLICATION AREA

TC 35 / TC 42

For copper, brass, aluminium, thin-walled steel pipes
 TC 35 Ø 6 - 35 mm / TC 42 Ø 6 - 42 mm

TC 35 MLP / TC 42 Pro MLP

PE, PP, PVDF, plastic-coated pipes, PVC hard plastic pipes
 TC 35 MLP Ø 6 - 35 mm / TC 42 Pro MLP Ø 6 - 42 mm

TC 35 INOX / TC 42 Pro INOX

Stainless steel pipes
 TC 35 INOX Ø 6 - 35 mm / TC 42 INOX Ø 6 - 42 mm

KEY FEATURES

- Optimal for confined spaces
- Quick adjustment of the working area
- Spare cutter wheel in handle
- Cuts near to flares are possible
- Retractable internal pipe deburrer
- Rugged and robust

**Metal casing with DURAMANT coating:
 rugged and robust**

Two guide rollers
 with recess

Cuts near to flares

Exact telescopic guide

Precise cutting

Cutter wheel
 compartment

Spare cutter wheel
 always within reach

Always within reach

Retractable internal
 pipe deburrer

Easy turning of the
 adjustment knob

Quick adjustment of the
 working area

For copper and aluminium



For MLP pipes



For INOX (stainless steel) pipes



For refrigeration technology



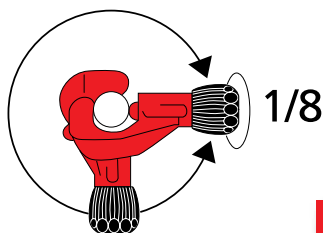
TUBE CUTTER 35 DURAMAG counter display

Counter display includes six TUBE CUTTER 35 DURAMAG

Product profile

KEY FEATURES

- Improved performance
- Higher stability with noticeably less weight



Constant, tight working radius of 123 mm



The 100% magnesium body is up to 30% lighter than the previous model!



No. 100002002



No. 070027DB

Set (No. 100002002) includes: TUBE CUTTER 35, 6 - 35 mm (70027), internal and external deburrer 6 - 35 mm (No. 150000237), permanent-marker Prepare to Press (No. 1500002640), ROBOX B2350 (No. 1500002641)

Set (No. 100002222) includes: TUBE CUTTER TC 35 INOX, 6 - 35 mm, DURAMAG (No. 70055), cutter wheel for TC 35 + TC 30 Pro + TC 42 XL (No. 070056D), ROBOX B2350 (No. 1500002641)

Model	mm	inch	g		No.
TUBE CUTTER 35 DURAMAG (Cu, brass, Al, thin-walled pipe)	6 - 35	1/4" - 1.3/8"	255	4	70027
Handtool set prepare to press	6 - 35	1/4" - 1.3/8"	460	1	100002002
TUBE CUTTER 35 DURAMAG counter display (6 pcs.)	6 - 35	1/4" - 1.3/8"	1,700	1	070027DB
TUBE CUTTER 35 DURAMAG MLP	6 - 35	1/4" - 1.3/8"	255	4	70108
TUBE CUTTER 35 PRO INOX DURAMAG (stainless steel)	6 - 35	1/4" - 1.3/8"	255	4	70055
TUBE CUTTER 35 INOX + cutter wheel set, ROBOX 5	6 - 35	1/4" - 1.3/8"	500	1	100002222 *
TUBE CUTTER 42 PRO (Cu, brass, thin-walled steel pipe)	6 - 42	1/4" - 1.5/8"	550	4	70029
TUBE CUTTER 42 PRO MLP	6 - 42	1/4" - 1.5/8"	550	1	70109
TUBE CUTTER 42 PRO PVC	6 - 42	1/4" - 1.5/8"	550	4	70072
TUBE CUTTER 42 PRO INOX (stainless steel)	6 - 42	1/4" - 1.5/8"	550	1	70070

* ROBOX system p. 336

TUBE CUTTER 42 XL

Pipe cutter for the precise cutting of metal pipes Ø 6 - 42 mm (1/4 - 1.5/8")

Product profile

APPLICATION AREA

- New cutter wheel: 20x more cuts**
- Suitable for thin-walled pipes starting at a wall thickness of 0.5 mm
- Quick adjustment of the pipe diameter by easy turning of the adjustment knob
- Spare cutter wheel in handle compartment
- Retractable internal pipe deburrer

KEY FEATURES

Application area: For copper, brass, aluminium, stainless steel and thin-walled steel pipes Ø 6 - 42 mm with a wall thickness of up to 1.2 mm

** Stainless steel compared to TC 42 Pro

Model	g		No.
TUBE CUTTER 42 XL	500	1	100001748
Spare cutter wheel (5 pcs.)	20	1	070056D



Cutting

Cutting metal, manual

1 ROTRAC 28 / 42

High-precision pipe cutter,
Ø 3 - 42 mm (1/8 - 1.5/8")



KEY FEATURES

- Constant working radius
- Cast aluminium design
- Protection of the cutter wheel with the rolling stop
- Retractable internal deburrer and spare cutter wheel in handle
- Protected screw spindle – protection against dirt and jamming

Model	mm	inch	g	No.
ROTRAC 28	3 - 28	1/8 - 1.1/8"	220	70010
ROTRAC 42	6 - 42	1/4 - 1.5/8"	255	70011
ROTRAC 28 PLUS chrome, limited edition			220	100000046
Spare axle			5	70080
Spare cutter wheel INOX			2	070007X
Spare cutter wheel (3 pcs.) for Cu, Al, brass			20	070007D

MINICUT I PRO / II PRO

Copper pipe cutter Ø 3 - 22 mm
(1/8 - 7/8")



Ideal for maintenance and repair work!



KEY FEATURES

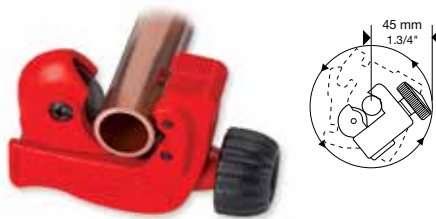
- For copper, brass, aluminium, thin-walled steel pipes
- Compact design with small working radius (38 mm and/or 1.1/2" I PRO/42 mm and/or 1.5/8" II PRO) allows use in hard-to-reach places
- Effortless pressure control with the large knurled knob and compact design
- Two guide rollers with recess for cuts near flares
- Monoblock design allows precision

Model	mm	inch	g	No.
MINICUT I PRO	3 - 16	1/8 - 5/8"	115	4 70401
MINICUT II PRO	6 - 22	1/4 - 7/8"	125	4 70402
Spare cutter wheel (5 pcs.)			20	1 070017D
Spare axle			5	1 70041

MINICUT 2000

Copper pipe cutter Ø 3 - 22 mm
(1/8 - 7/8")

Ergonomic design of body and knob with seating surface for the hand during turning



KEY FEATURES

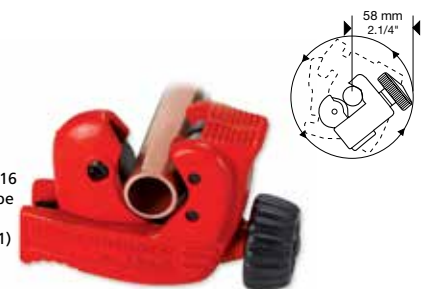
- For copper, brass, aluminium, thin-walled steel pipes
- Compact design with small working radius (45 mm and/or 1.3/4") allows use in hard-to-reach places
- Effortless pressure control with the large knurled knob and compact design
- Two guide rollers with recess for cuts near flares

Model	mm	inch	g	No.
MINICUT 2000	3 - 22	1/8 - 7/8"	140	4 70105
Spare cutter wheel (5 pcs.)			20	1 070017D
Spare axle			5	1 70041

MINI MAX

Copper pipe cutter Ø 3 - 28 mm
(1/8 - 1.1/4")

Ergonomic design of body and knob with seating surface for the hand during turning



Set (No. 100002191) includes:
MINICUT I PRO pipe cutter, 3 - 16 mm (No. 70401), MINI MAX pipe cutter, 3 - 28 mm (No. 70015), ROBOX B2350 (No. 1500002641)

KEY FEATURES

- For copper, brass, aluminium, thin-walled steel pipes
- Compact design with very small working radius (58 mm and/or 2.1/4") allows use in hard-to-reach places
- Effortless pressure control with the large knurled knob and compact design
- Two guide rollers with recess for cuts near flares

Model	mm	inch	g	No.
MINI MAX	3 - 28	1/8 - 1.1/8"	270	4 70015
Spare cutter wheel (5 pcs.)			20	1 070017D
Spare axle			5	1 70041

TUBE CUTTER 30 PRO / 50

Copper pipe cutter Ø 3 - 50 mm (1/8 - 2")

KEY FEATURES

- For copper, brass, aluminium, thin-walled steel pipes
- Two guide rollers with recess for cuts near flares
- Retractable internal deburrer and spare cutter wheel in handle



No. 71019

Model	mm	inch	g		No.
TUBE CUTTER 30 PRO	3 - 30	1/8 - 1.1/8"	305	4	71019
TUBE CUTTER 50	12 - 50	1/2 - 2"	520	1	70065

Model	g		No.
Spare cutter wheel (5 Pcs.)	20	1	070017D
Spare axle	5	1	70041

Automatic ratchet telescopic pipe cutter

Telescopic pipe cutter Ø 6 - 67 mm (1/4 - 2.5/8")

KEY FEATURES

- For copper, brass, aluminium, thin-walled steel pipes as well as plastic-coated pipes
- Retractable internal deburrer and spare cutter wheel in handle
- Monoblock design
- Quick adjustment with the ratchet telescopic guide with automatic spring-driven release
- Self-clamping prevents release due to quick adjustment during the cutting process



No. 70030



Model	mm	inch	g		No.
Size 1	6 - 67	1/4 - 2.5/8"	755		70030
Size 1 spare deburring blade			5	10	21652
Size 1 spare cutter wheel (5 pcs.)			20	1	070017D
Size 2 spare cutter wheel (2 pcs.)			20		070057D
Size 2 spare deburring blade			5	10	21652

Model	mm	inch	g	No.
Size 2	50 - 127	2 - 5"	1,850	70142
Size 1 spare axle			20	70042
Size 1 spare deburrer complete			5	750004100
Size 2 spare axle			5	751004200

Chain pipe cutter

For pipes Ø 20 - 100 mm (1 - 4")

KEY FEATURES

- For copper, brass, aluminium, thin-walled steel pipes as well as plastic-coated pipes
- Ideal for working in confined spaces, e.g. parallel-running pipes
- Robust chain with 15 mini cutter wheels, two-step adjustment, chrome-plated with plastic covered handles

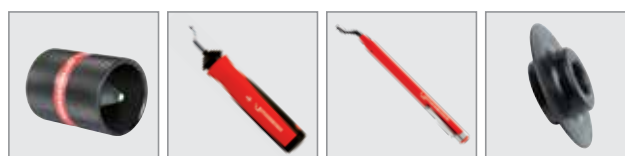


No. 70285

Model	mm	inch	g	No.
Chain pipe cutter	20 - 100	1 - 4"	575	70285
Spare cutter wheel chain			180	70286

ACCESSORIES

Model		No.
Internal / external deburrer, Ø 6 - 35 mm	26	1500000237
Internal / external deburrer, Ø 10 - 54 mm	26	1500000236
GRATFIX	28	21655
UNIGRAT	28	21660
Spare cutter wheels	15	



Cutting

Cutting metal, manual

1 ROSLICE

Copper pipe cutter Ø 12 - 22 mm (1/2" - 1.1/8")



Ergonomic form

Less space needed, ideal for hard-to-reach places



Pipe cutting possible near the wall



Indicates rotating direction

Quick cutting with just a few turns

KEY FEATURES

- Quick cutting of copper pipes with less turns
- No deformation of the pipe: self-clamping and self-alignment
- Less space required, ideal for hard-to-reach places
- Reliable hold with the non-slip surface

Self-clamping and self-alignment

Prevents the deformation of the pipe

Non-slip surface

Reliable grip

Model	mm/inch	g	No.
ROSLICE	12 mm	240	88812
ROSLICE	15 mm	230	88815
ROSLICE	18 mm	260	88818
ROSLICE	22 mm	250	88822
ROSLICE	3/4"	240	88832
Spare cutter wheel (5 pcs.)	1/2", 12 mm	36.3	088840D
Spare cutter wheel (5 pcs.)	5/8"-7/8", 15-22 mm	34.6	088841D
Spare cutter wheel (5 pcs.)	1/2"-3/4", 18 mm	37.4	088842D

TUBE CUTTER 30 PRO INOX

Stainless steel pipe cutter Ø 3 - 30 mm (1/8" - 1.1/8")
for the precise cutting of stainless steel pipes

INOX



2 guide rollers with recess

Cut near flares



Precise cutting of stainless steel pipes



Internal deburrer

Retractable

Cutter wheel compartment

Spare cutter wheel always within reach

KEY FEATURES

- Retractable internal deburrer and spare cutter wheel in handle
- Two guide rollers with recess for cuts near flares

Model	mm	inch	g	No.
TC 30 PRO INOX	3 - 30	1/8" - 1.1/8"	305	1 71085
Spare cutter wheel (5 pcs.)			20	1 070056D
Spare axle			5	1 70041

TUBE CUTTER INOX

Ratchet telescopic pipe cutter Ø 6 - 60 mm (1/4 - 2.3/8") for the precise cutting of stainless steel pipes

KEY FEATURES

- Quick adjustment with the ratchet telescopic guide with automatic spring-driven release

12 x ball bearings!

Model	mm	inch	g	kg	No.
TUBE CUTTER INOX 6 - 60	6 - 60	1/4 - 2.3/8"	305	1	70340
Spare cutter wheel (2 pcs.)			20	1	70341



Rugged and robust

TUBE CUTTER 35 / 42 PRO INOX

Proven pipe cutter Ø 6 - 42 mm (1/4 - 1.5/8") for the precise cutting of stainless steel pipes

KEY FEATURES

- Hardened, special cutter wheel made of high-alloyed steel
- External burr-free cutting
- Stainless steel guide rolls, cuts near flares possible
- Optimum use in tight places
- Quick adjustment of the working area
- Retractable pipe internal deburrer
- Rugged and robust

Model	mm	inch	g	kg	No.
TC 35 INOX	6 - 35	1/4 - 1.3/8"	440	4	70055
TC 42 PRO INOX	6 - 42	1/4 - 1.5/8"	510	1	70070

Set (No. 100002222) includes: TUBE CUTTER 35 INOX, (No. 70055), cutter wheel f. TC 35 + TC 30 PRO + TC 42 XL, 5 pcs. (No. 070056D), ROBOX B2350 (No. 1500002641)

INOX



Model	g	kg	No.
Spare cutter wheel (5 pcs.)	20	1	070056D
Spare deburring blade	10	10	21652

TUBE CUTTER CSST

Pipe cutter for the precise cutting of corrugated INOX pipes Ø 10 - 42 mm (3/8" - 1.5/8")

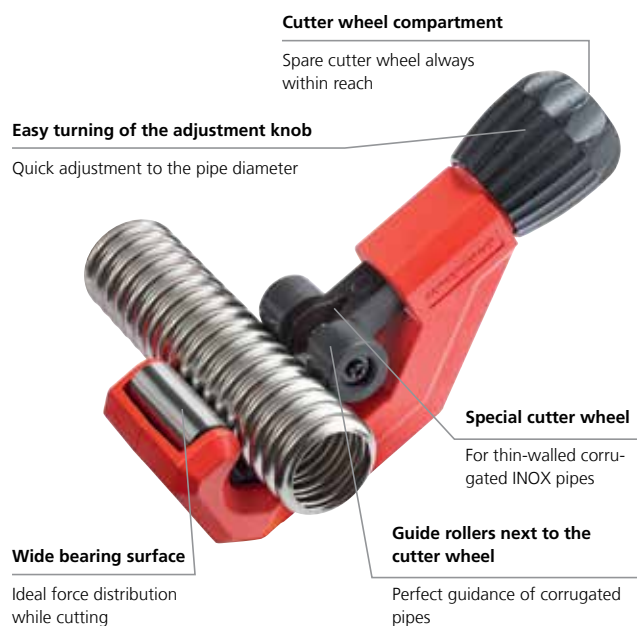
KEY FEATURES

- Stability provided by two wide rubber rollers
- Quick adjustment to the pipe diameter
- Spare cutter wheel in handle compartment

APPLICATION AREA

Corrugated pipes with a wall thickness of up to 0.2 mm

Model	kg	No.
TUBE CUTTER CSST 42 mm	0.5	1
Cutter wheel CSST pipe (5 pcs.)		1



Cutting

Cutting metal, manual

1 ENORM 4"

Steel pipe cutter Ø 60 - 115 mm (2 - 4")



KEY FEATURES

- Wide rollers for secure guiding of cutter wheel on pipe
- Easy pressure control for optimum force transmission onto the pipe

KEY FEATURES

- Long service life with the hardened cutter wheel made of high-alloyed steel
- Burr-free cutting allows immediate thread cutting

Thread for handle



Handle (included in delivery)



Model	mm	inch	g	No.	Model	g	No.
ENORM 4"	60 - 115	2 - 4"	7,105	70060	Spare axle	5	70064
Spare cutter wheel (2 pcs.)				20	070061D		

SUPER 1.1/4" and 2"

Stainless steel pipe cutter Ø 10 - 60 mm (1/8 - 2")

KEY FEATURES (SUPER/SUPER INOX)

- Wide rollers for secure guiding of cutter wheel on pipe
- Easy pressure control for optimum force transmission onto the pipe

SUPER 1.1/4" and 2" INOX

Stainless steel pipe cutter Ø 10 - 60 mm (1/8 - 2")

KEY FEATURES (SUPER/SUPER INOX)

- Long service life with the hardened cutter wheel made of high alloy steel
- Burr-free external cutting allows for immediate thread cutting

Precise cutting of stainless steel pipes

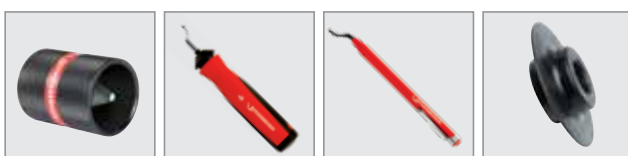


INOX



Model	mm	inch	g	No.	Model	mm	inch	g	No.
SUPER 1.1/4"	10 - 42	1/8 - 1.1/4"	1,040	70040	SUPER 1.1/4" INOX	10 - 42	1/8 - 1.1/4"	1,040	70086
SUPER 2"	10 - 60	1/8 - 2"	2,155	70045	SUPER 2" INOX	10 - 60	1/8 - 2"	2,155	70087
1.1/4" spare cutter wheel (3 pcs.)				20	070046D	1.1/4" spare cutter wheel (2 pcs.)			
1.1/4" spare axle				5	701011500	1.1/4" spare axle			
2" spare cutter wheel (3 pcs.)				20	070051D	2" spare cutter wheel (2 pcs.)			
2" spare axle				5	70053	2" spare axle			

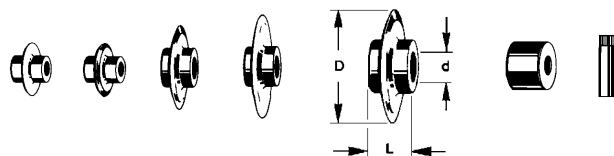
ACCESSORIES



Model	No.
Internal / external deburrer, Ø 6 - 35 mm	32 1500000237
Internal / external deburrer, Ø 10 - 54 mm	32 1500000236
GRATFIX	34 21655
UNIGRAT	34 21660
Spare cutter wheels	21

Pipe cutters, cutting wheels and spare parts

Only original ROTHENBERGER cutting wheels made of high-alloyed hardened steel guarantee an exact, right-angled cut



1



Pipe cutter type	Model for pipe - Ø	No.	Cutting wheel No.	Sizes d, L, D mm	Cutting depth	Spare axle No.	Ø mm Length mm Thread	Spare roller No.	Deburring blade No.	Application area	
MINICUT I PRO MINICUT II PRO	3 - 16 mm	70401	070017D	4.8 / 5.90 / 18.5	3.0	70041	4.7 / 14 / M3	70023	-	Copper pipe (Cu), brass pipe (Ms), aluminium pipe (Al), thin-walled steel pipe (Fe), PVC hard plastic pipe, plastic-coated pipe	
	6 - 22 mm	70402	070017D	4.8 / 5.90 / 18.5	3.0	70041	4.7 / 14 / M3	70023	-		
MINICUT 2000	3 - 22 mm	70105	070017D	4.8 / 5.90 / 18.5	3.0	70041	4.7 / 14 / M3	-	-		
MINIMAX	3 - 28 mm	70015	070017D	4.8 / 5.90 / 18.5	3.0	70041	4.7 / 14 / M3	-	-		
TUBE CUTTER 30 PRO	3 - 30 mm	71019	070017D	4.8 / 5.90 / 18.5	3.0	70041	4.7 / 14 / M3	70067	-	Copper pipe (Cu), brass pipe (Ms), aluminium pipe (Al), thin-walled steel pipe (Fe), PVC hard plastic pipe, plastic-coated pipe	
TUBE CUTTER 35 + 35 C TUBE CUTTER 42 PRO	6 - 35 mm 6 - 42 mm	070027(C) 70029	070017D 070017D	4.8 / 5.90 / 18.5 4.8 / 5.90 / 18.5	3.0 3.0	70041 70041	4.7 / 14 / M3 4.7 / 14 / M3	70067 70067	21652 21652		
TUBE CUTTER 35 MLP TUBE CUTTER 42 PRO MLP	6 - 35 mm 6 - 42 mm	70108 70109	070188D 070188D	4.8 / 5.90 / 19.3 4.8 / 5.90 / 19.3	4.0 4.0	70041 70041	4.7 / 14 / M3 4.7 / 14 / M3	70067 70067	21652 21652		
TUBE CUTTER 50	12 - 50 mm	70065	070017D	4.8 / 5.90 / 18.5	3.0	70006	4.7 / 16 / M4	-	-	Multi-layered composite pipe	
AUTOMATIC pipe cutter	Size 1 6 - 67 mm	70030	070017D	4.8 / 5.90 / 18.5	3.0	70042	4.7 / 16 / M4	-	21652	Cu, Ms, Al, Fe thin-walled	
		70031	070028D	4.8 / 5.90 / 23.6	7.0	70042	4.7 / 16 / M4	-	21652	PE, PP, VPE, PB and PVDF pipes	
		70142	070057D	8.0 / 14.0 / 29.0	7.0	751004200	7.9 / 23.5 / 1/4"	-	21652	thin-walled Cu, Ms, Al, Fe	
	Size 2 50 - 127 mm	70032	055054D	8.0 / 13.0 / 40.0	13.0	751004200	7.9 / 23.5 / 1/4"	-	21652	PE, PP, VPE, PB and PVDF pipes	
		70032	055053D	8.0 / 13.0 / 30.5	8.0	751004200	7.9 / 23.5 / 1/4"	-	21652	thin-walled PP pipes	
		70032	055074D	8.0 / 11.0 / 45.0	16.0	751004200	7.9 / 23.5 / 1/4"	-	21652	PE, PP, VPE, PB and PVDF pipes	
	Size 3 100 - 168 mm	70033	055074D	8.0 / 11.0 / 45.0	16.0	751004200	7.9 / 23.5 / 1/4"	-	21652	PE, PP, VPE, PB and PVDF pipes	
		70033	055053D	8.0 / 11.0 / 30.5	8.6	751004200	7.9 / 23.5 / 1/4"	-	21652	thin-walled PP pipes	
	TUBE CUTTER 28 TUBE CUTTER 42	3 - 28 mm 3 - 42 mm	70010 70011	070007D 070007D	4.8 / 3.0 / 16.0 4.8 / 3.0 / 16.0	2.5 2.5	70080 + 70081 70080 + 70081	4.7 / 9 / SR 4.7 / 9 / SR	80679 80679	-	Cu, Ms, Al, Fe thin-walled Cu, Ms, Al, Fe thin-walled
	TUBE CUTTER 42 PRO PVC	6 - 42 mm	70072	070028D	4.8 / 5.90 / 23.6	7.0	70041	4.7 / 14 / M3	70067	-	PE, PP, VPE, PB and PVDF pipes
Steel pipe cutter SUPER	1/8" - 1.1/4" 1/8" - 2"	70040 70045	070046D 070051D	7.5 / 14.0 / 25.7 9.0 / 17.0 / 31.5	5.5 6.0	701011500 70053	7.4 / 30 / - 8.9 / 35 / -	70047 70052	-	Steel pipe (Fe) Steel pipe (Fe)	
Steel pipe cutter ENORM	2" - 4"	70060	070061D	9.7 / 20.0 / 41.0	8.0	70064	9.4 / 52 / -	70063	-	Steel pipe (Fe)	
TUBE CUTTER 30 PRO INOX	3 - 30 mm	71085	070056D	4.8 / 5.9 / 18.5	5.5	70041	4.7 / 14 / M3	70068	-	Stainless steel pipe	
TUBE CUTTER INOX	10 - 54 mm	70340	70341	5.0 / 21.0 / 30.0	3.5	753000700	4.7 / 14 / M3	70068	21652	Stainless steel pipe	
TUBE CUTTER 35 INOX TUBE CUTTER 42 PRO INOX	6 - 35 mm 6 - 42 mm	70055 70070	070056D 070056D	4.8 / 5.90 / 18.5 4.8 / 5.90 / 18.5	4.0 4.0	70041 70041	4.7 / 14 / M3 4.7 / 14 / M3	70068 70068	21652 21652	Stainless steel pipe Stainless steel pipe	
SUPER INOX	1/8" - 1.1/4" 1/8" - 2"	70086	070088D	4.8 / 5.90 / 19.3	4.0	701011500	7.4 / 30 / -	70047	-	Stainless steel pipe	
		70087	070089D	9.0 / 19.0 / 31.5	7.0	70053	8.9 / 35 / -	70052	-	Stainless steel pipe	
Chain pipe cutter	100 mm	70285	-	4.0 / 3.80 / 17.8	3.0	-	-	-	Spare chain 70286	Cu, Ms, Al, Fe thin-walled	

Cutting

Cutting plastic / MLP, manual

1 ROCUT

Plastic pipe shears up to Ø 75 mm (3")

The ROTHENBERGER plastic pipe shears for highest quality requirements. Knife blades deliver clean and straight cuts on pipe diameters up to 75 mm of plastic types currently used in installations. The aluminium construction makes for precise operation and long life.

Product profile

APPLICATION AREA

For precise cutting of PP, PE, PEX, PB, PVC, PVDF and MLP pipes up to Ø 75 mm

KEY FEATURES

- Minimum effort during cutting
- Precise right-angled cuts
- Pin-point precision without deformation
- Precise pressure transfer and guided cutter feed
- Automatic, controlled opening of the blade at the push of a button

KEY FEATURES

- Secure grip with the rubberised handles
- Shear arms lockable in transport position

TECHNICAL DATA

ROCUT Professional:

TC 42: Ø 0 - 42 mm

TC 50: Ø 0 - 50 mm

TC 63: Ø 0 - 63 mm

TC 75: Ø 0 - 75 mm

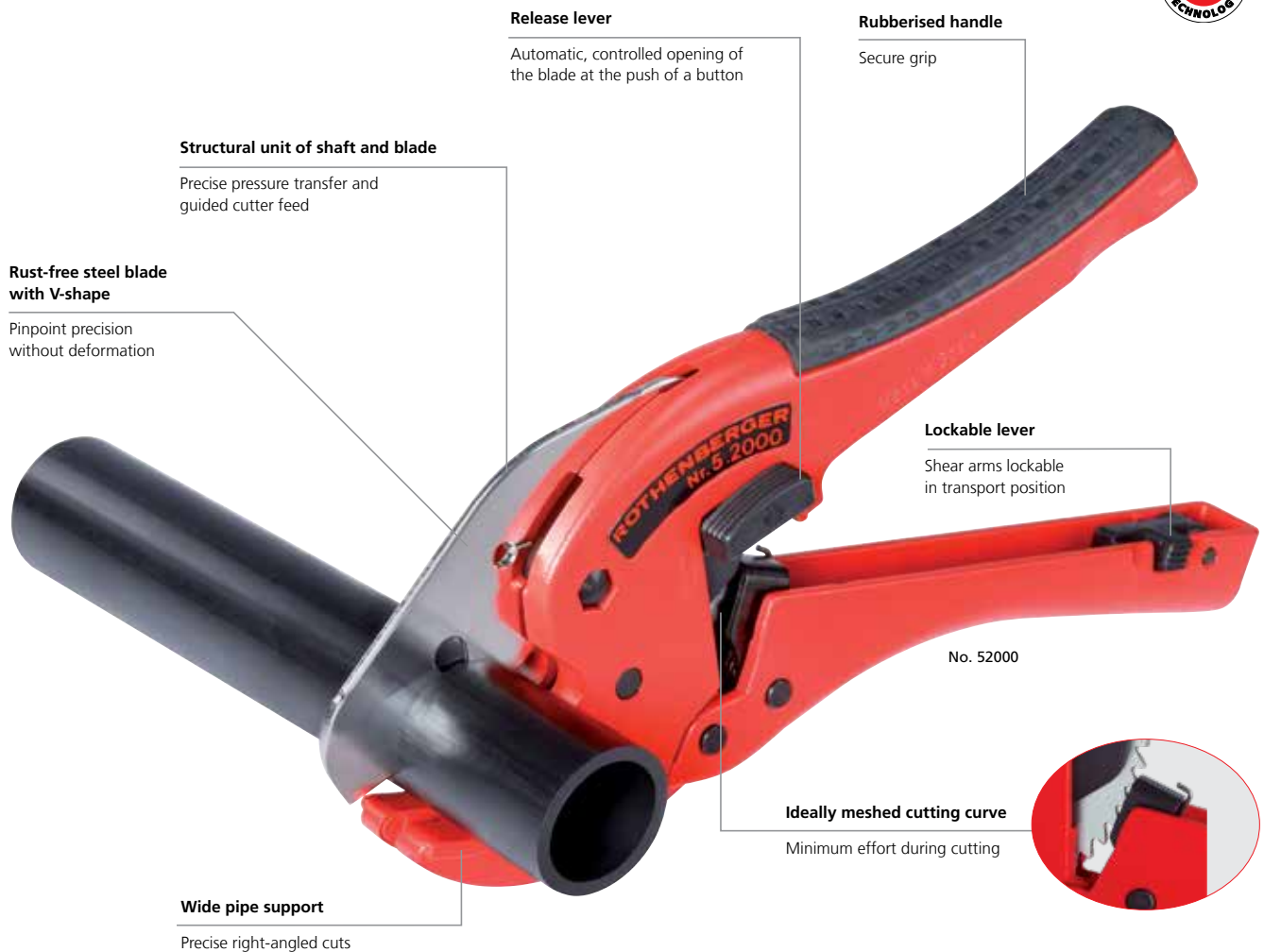
ROCUT Standard:

TC 26: Ø 0 - 26 mm

TC 32: Ø 0 - 32 mm

PS 35: Ø 6 - 35 mm

PS 26/42: Ø 6 - 42 mm



ROCUT 42 Twin Cut

Shear for cutting all common plastic pipes with a diameter of 0–42 mm

With the ROCUT 42 Twin Cut you can cut faster, clean and straight and with even less effort on all common plastic pipes up to 42mm.

Product profile

APPLICATION AREA

Manual plastic pipe shear for cutting PP-, PE-, PEX-, PB- and PVDF pipes up to Ø 42 mm.

KEY FEATURES

- Combines due to its unique function two shears: pipes can be cut in the one cut or ratchet cut function
- With the one cut function pipes can be cut 80% faster. You also save time since little calibration is needed.¹⁾
- Ratchet cut function: if the pipe dimension is too large or the material too thick for a one cut, the shear automatically switches into the ratchet mode

KEY FEATURES

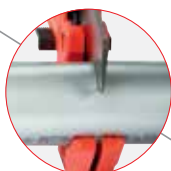
- The quick adjustment of the blade moves directly to the pipe and saves time at work
- Cutting requires 20% less effort due to the PTFE coated blade.²⁾

TECHNICAL DATA

Working range direct cut: Ø 0 – 20mm
Working range ratchet cut: Ø 20 – 42mm
Blade: V-Contour , PTFE coated
Suitable for: PP, PE, PEX, PB, PVDF
Product weight: 550g

PTFE coated blade

Less force needed for a straight cut



Innovative mechanism

Shear automatically switches from one to ratchet cut function



Non-slip handles

Good grip while working



Symmetric reset lever

Comfortable resetting for left- and right-handers

Two stage pipe holder

For pipes 0–20 and 20–42mm. Less cutting effort, less deformation.

Powerful cutting with the ratchet function.



With the one cut function pipes can be cut 80% faster. You also save time since little calibration is needed.¹⁾



Model	mm	inch	g		No.
ROCUT 42 Twin Cut	0 - 42	0 - 1.5/8"	550	1	1000003011
Spare blade for ROCUT 42 Twin Cut	0 - 42	0 - 1.5/8"	120	1	1000003104

¹⁾ Internally tested. In comparison to the previous ROCUT TC 42 with a 16 mm pipe.

²⁾ Internally tested. In comparison to the previous ROCUT TC 42 without PTFE coated blade.

Cutting

Cutting plastic / MLP, manual

1 ROCUT TC 50 / TC 75 Professional

Plastic pipe shears up to Ø 75 mm (3")



No. 52010

No. 52015

ROCUT TC 26 / TC 32 PS 26 / PS 42 S / PS 35 S

Plastic pipe shears up to Ø 42 mm (1.5/8")
(TC 32 for multi-layer composite pipes MLP)



No. 52005



No. 52040

ROCUT TC 63 Professional

Plastic pipe shears up to Ø 63 mm (2.1/2")
(TC 63 Professional for PVC pipes)



No. 55005 / No. 55015

Model	mm	inch	g		No.
ROCUT TC 26	0 - 26	0 - 1"	370	4	52005
ROCUT TC 32	0 - 32	0 - 1.1/4"	220	4	52040
ROCUT PS 35	6 - 35	1/4 - 1.3/8"	740	4	55005
ROCUT PS 26 / 42 S, adjustable	6 - 42	1/4 - 1.5/8"	950	1	55015
ROCUT TC 42 Professional	0 - 42	0 - 1.5/8"	447	4	52000
ROCUT TC 50 Professional	0 - 50	0 - 2"	600	6	52010
ROCUT TC 63 Professional	0 - 63	0 - 2.1/2"	700	6	52030
ROCUT TC 75 Professional	0 - 75	0 - 3"	1,600	1	52015

ACCESSORIES



Model	mm	inch	g		No.
Spare stainless steel blade for TC 32	0 - 32	0 - 1.1/4"	120	1	52041
Spare stainless steel blade for PS 35 S	6 - 35	1/4 - 1.3/8"	30	1	55006
Spare stainless steel blade for PS 26 / 42 S	6 - 42	1/4 - 1.5/8"	60	1	55007
Spare stainless steel blade for TC 42 Professional	0 - 42	0 - 1.5/8"	120	1	52042
Spare stainless steel blade for TC 50 Professional	0 - 50	0 - 2"	120	1	52011
Spare stainless steel blade for TC 63 Professional	0 - 63	0 - 2.1/2"	130	1	52031
Spare stainless steel blade for TC 75 Professional	0 - 75	0 - 3"	190	6	52016

ROCUT 110 / ROCUT 160

Cutting and chamfering tool for right-angled cutting and chamfering (15°), Ø 32 - 160 mm

Product profile

APPLICATION AREA

Suitable for thin and thick-walled PVC, PE, PP, PEX, PB and PVDF pipes, as well as sound-insulated drain pipes. Utmost precision in a single operation

KEY FEATURES

- Only one tool required for cutting, chamfering and deburring
- Extremely long service life with optimum cutting geometry
- Special accessories for PE, PP, PEX, PB and sound-insulated pipes

KEY FEATURES

- Uniform chamfering of the entire pipe circumference
- Continuously adjustable pipe clamping pressure
- Integrated internal deburrer is stored in the handle
- Pipe cutting also possible without chamfering, as cutter blade shaft can be mounted with 180° offset

TECHNICAL DATA

ROCUT 110: Ø 32 - 110 mm
ROCUT 160: Ø 110 - 160 mm



No. 55035

Set (No. 55035) includes: ROCUT 110 (No. 55020), internal deburrer (No. 55018), 2 clamping set 50 and 75mm, cutter blade shaft with automatic copying and HM cutter blade inserts 7,5mm (No. 54960), ROCASE inlay (No. 1300005864), ROCASE 4414 red w/o inlay (No. 1300003541)



No. 55063

Set (No. 55063) includes: ROCUT 160 (No. 55030), internal deburrer (No. 55018), 2 clamping sets, cutter blade shaft with automatic copying and, HM cutter blade insert 12,5mm (No. 55019), ROCASE inlay (No. 1300005864), ROCASE 4414 red w/o inlay (No. 1300003541)



Handheld operation



Clamping in a parallel vice



ROCUT 160 with cutter blade



ROCUT 110 with cutter wheel (No. 54950) (special accessories)



Model	Working range Ø mm	kg	No.
ROCUT 110 set	50, 75, 110	3.9	55035

Model	Working range Ø mm	kg	No.
ROCUT 160 set	110, 125, 160	5.6	55063

ACCESSORIES

Model	g	kg	No.
Cutter blade for internal deburrer	10	10	21652
ROCASE inlay	377		1300005864
ROCASE 4414 red w/o inlay	1,300		1300003541
Internal deburrer with blade	150		55018



Cutting

Cutting plastic / MLP, manual

1



No. 55020



ROCUT 110 with cutter wheel (No. 54950) (special accessories)



ROCUT 110

Basic unit Ø 32 - 110 mm

For use with clamping sets Ø 32 - 100 mm, without internal deburrer, with standard cutter blade shaft and cutter blade (No. 55029)

Model	 mm	 g	No.
Basic unit ROCUT 110	110	2,450	55020
Clamping set*	100	110	55048
Clamping set*	90	150	55021
Clamping set*	80	170	55047
Clamping set*	75	210	55022
Clamping set*	63	220	55023
Clamping set*	56	270	55024
Clamping set*	50	290	55025
Clamping set*	40	300	55027
Clamping set*	32	330	55026

*Clamping set (1 set = 2 semi-circular segments)



No. 55030



ROCUT 160 with cutter blade



ROCUT 160

Basic unit Ø 110 - 160 mm

Cutter blade shaft with automatic copying and cutter blade (No. 55019), for use with clamping sets Ø 110 - 140 mm, without internal deburrer

Model	 mm	 g	No.
Basic unit ROCUT 160	160	3,450	55030
Clamping set*	140	180	55031
Clamping set*	125	250	55032
Clamping set*	110	310	55033

*Clamping set (1 set = 2 semi-circular segments)



No. 54960



No. 54961

With automatic copying




No. 55029

No. 55019

HM cutter blade inserts

ROCUT 110 and ROCUT 160

Model	Cutting depth mm	 g	No.
Cutter blade shaft with Automatic copying and HM cutter blade inserts	7.5	110	54960
Cutter blade shaft with Automatic copying and HM cutter blade inserts	12.5	120	54961
Spare HM cutter blade insert for Cutting and chamfering 15°	7.5	10	55029
Spare HM cutter blade insert for Cutting and chamfering 15°	12.5	20	55019



No. 54950


No. 055053D

No. 055054D

No. 055074D

Cutter wheels

ROCUT 110 and ROCUT 160

Model	Cutting depth mm	 g	No.
Cutter blade shaft with Cutter wheel (No. 55074)	16.0	130	54950
Spare cutter wheels (2 pcs.)	8.6	10	055053D
Spare cutter wheels (3 pcs.)	13.0	20	055054D
Spare cutter wheels (2 pcs.)	16.0	20	055074D



TUBE CUTTER 67 / 125 / 168 PL Automatic

Telescopic ratchet pipe cutter
Ø 6 - 168 mm (1/4 - 6.5/8")

Product profile

APPLICATION AREA

For precise cutting of PP, PE, PEX, PB and PVDF pipes as well as sound-insulated drain pipes

KEY FEATURES

- Maximum strength with the monoblock aluminium construction
- Optimum, fatigue-free operation with the ergonomically optimised metal handle
- Fast adjustment to the outer tube diameter with the telescopic ratchet guide
- Fast opening with automatic retraction
- Internal pipe deburrer retracts into cutter body
- Hardened, specially sharpened cutter wheels

TECHNICAL DATA

TC 67 PL:	6 - 67 mm	1/4 - 2.5/8"
TC 125 PL:	50 - 125 mm	2 - 5"
TC 168 PL:	110 - 168 mm	4.3/8" - 6.5/8"



No. 70033



No. 070031D

Removable
internal pipe
deburrer



Model	mm	inch	Cutting- depth	kg		No.
TC 67 PL	6 - 67	1/4 - 2.5/8"	7.0	0.7	4	70031
TC 125 PL	50 - 125	2 - 5"	13.0	1.6	1	70032
TC 168 PL	110 - 168	4 - 6.5/8"	16.0	1.7	1	70033

Cutting wheels, spare parts 21

Jacket pipe cutter

For cutting of grooved plastic protective pipe
(corrugated hose) up to 32 mm

KEY FEATURES

- Ideal tool for the removal of the protective hose on pipes
- Very robust
- Simple and precise use
- Saves time in comparison to conventional use of a blade



Model	mm	No.
Jacket pipe cutter	0 - 32 mm	21500
Spare blade ROCUT PPD		21505

Cutting

Cutting plastic / MLP, manual

1 TUBE CUTTER 35 MLP / 42 PRO MLP / 42 PRO PVC

Telescopic pipe cutter Ø 6 - 42 mm (1/4 - 1.5/8")

Product profile

APPLICATION AREA

TUBE CUTTER 35 MLP and 42 PRO MLP for multi-layer composite pipes TUBE CUTTER 42 PRO PVC for PVC pipes

KEY FEATURES

- Space-saving work, also in confined spaces, uniform, small working radius of 123 mm
- Right-angled and burr-free cutting with precise telescopic guidance
- Fast and simple adjustment of the working range due to the feed being synchronised with the feeder rotation
- Optimum, fatigue-free operation with the optimised ergonomic handle
- Only one tool for cutting and deburring due to integrated, retractable internal pipe deburrer
- Spare cutter wheel in the handle

TECHNICAL DATA

TC 35 MLP:	6 - 35 mm	1/4 - 1.3/8"
TC 42 PRO MLP:	6 - 42 mm	1/4 - 1.5/8"
TC 42 PRO PVC:	6 - 42 mm	1/4 - 1.5/8"



No. 70108

Model	mm	inch	g		No.
TC 35 MLP	6 - 35	1/4 - 1.3/8"	440	4	70108
Spare cutter wheel TC 35/42 MLP (5 pcs.)	19	1			070188D


Model	mm	inch	g		No.
TC 42 PRO MLP	6 - 42	1/4 - 1.5/8"	510	1	70109
TC 42 PRO PVC	6 - 42	1/4 - 1.5/8"	510	4	70072
Spare cutter wheel TC 42 PVC (3 pcs.)	10				070028D

ROBO Super

Safety saw frame

- Minimizes risks: safety handle with exact guidance
- Room for spare blades in holder
- Optimum saw blade tensioning: quick tensioning device with fine adjustment integrated in handle
- Ideal for cutting in confined spaces: 90° rotatable




Model	Clamping width mm	 g	No.
ROBO Super saw frame including saw blade HSSE 4 Plus (No. 71213)	300	680	71206

ROBO Mini

Small saw frame

- Handle with ergonomic form enables powerful sawing in tight spaces
- Large dimension tightening screw




Model	Clamping width mm	 g	No.
ROBO Mini including UNIVERSAL saw blade (No. 71217)	150	160	71222

Metal saw frame

- Solid design with robust holder
- With cross-slotted squared clamping elements
- Reliable captive blade holding pin
- Firm wooden handle

Cross-slotted squared clamping piece





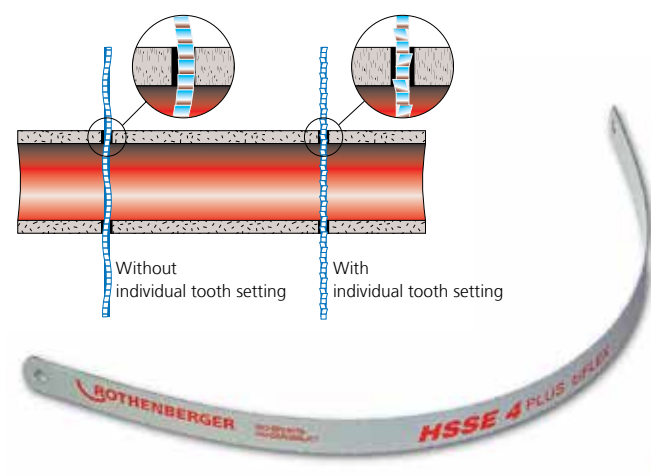
Model	Clamping width mm	 g	No.
Metal saw frame without saw blade	300	530	300013

UNI small saw PUK

- For sawing all materials, small and handy, good cutting performance



Model	Clamping width mm	 g		No.
PUK static, with UNIVERSAL saw blade	150	100		842100
PUK adjustable, with UNIVERSAL saw blade (w. App.)	150	140		71215
UNIVERSAL saw blade for metal	150 (32 TPI)	20	12	71217
Saw blade for wood	150 (14 TPI)	20	12	71216



Hand saw blades with single offset teeth optimally cut the hand saw blade free. Jamming in the workpiece is prevented. Therefore, the working rhythm is maintained, less effort is needed and there is a higher cutting performance.



HSSE 4 Plus

Bimetal hand saw blade

Highly flexible spring band steel with fused HSSE cutter

- Highest flexibility with extremely hard teeth
- Hardness approx. 65 HRC: Average service life 4 times longer
- Risk of breakage significantly reduced even under extreme operational demands
- Precise cutting with individual tooth setting



Model	mm	TPI	 g		No.
HSSE 4 Plus	300	24	20	100	71213

Cutting

Sawing, electric

1 PIPECUT mini

Cordless combi-pipe saw

New way of cutting: precise, versatile, independent

Product profile

APPLICATION AREA

For new installations and maintenance in the HVAC and industry sector.

KEY FEATURES

- Copper, plastic, C-steel, cast iron or stainless steel can be reliably cut in an 90 degree angle up to a pipe diameter of 110 mm
- Cut mounting rails or threaded bolts -easy and fast
- Transform the PIPECUT mini into a circular saw, into a plunge saw or into a cross-cutting saw

KEY FEATURES

- Three new, high-quality saw blades
- Stationary and mobile use
- CAS battery system for maximum independence

TECHNICAL DATA

Power supply: 18V CAS battery system

Idle speed: 4150 rpm / 28-30 m/s

Saw blade clamp: Ø 20 mm

Product dimension: 330 x 246 x 258 mm

Product weight: 4.3 kg (without battery)

Powerful 18V battery

Up to 140 cuts with just one battery charge (18V/4.0Ah, C-steel Ø42mm)

Additional high quality, fire-resistant bag

For absorbing shaving

Extra contact surface with ball bearing

For rotating and for cutting pipes over Ø 42 and up to 110 mm

Additional notch

For cutting threaded bolts

Brushless Motor

For wear-free work and longer machine life

Three new high quality saw blades

For a precise cutting performance

Convertible guide rail

For using the PIPECUT mini as circular saw, plunge saw or cross-cutting saw

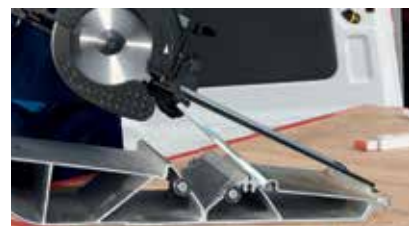
Copper, plastic, C-steel, cast iron or stainless steel can be cut up to a pipe diameter of 110 mm.



Transform the PIPECUT mini into a circular saw, into a plunge saw or into a cross-cutting saw.



Clamp function enables fastest cutting performance for different materials.



PIPECUT mini sets

All sets includes:

PIPECUT mini Baretool, guide rails for cutting pipes, DURACUT Uni saw blade, pipe support stand and ROCASE 6427 with inlay



No. 100003165

Model	kg		No.
PIPECUT mini, DURACUT Uni saw blade, with pipe support stand, with ROCASE 6427	5.4	1	100003374
PIPECUT mini, DURACUT Uni saw blade, with pipe support stand, with ROCASE 6427, CAS battery Li-Power 4.0Ah 18V and battery charger EU	6.2	1	100003165
PIPECUT mini, DURACUT Uni saw blade, with pipe support stand, with ROCASE 6427, CAS battery Li-Power 4.0Ah 18V and battery charger EU, with cross cut guide rail	6.8	1	100003398

ACCESSORIES



Model	kg		No.
DURACUT Uni saw blade	0.1	1	150003621
Universal saw blade for copper, plastic, profiles, threaded rods, aluminium- and decor plates	0.1	1	150003673
DURACUT St saw blade	0.1	1	150003674
Steel saw blade for steel and cast iron pipes	0.1	1	150003674
DURACUT X saw blade	0.1	1	150003694
INOX Saw blade for INOX-pipes	0.4	1	150003694
Cross cut guide rail	0.5	1	150003693
Pipe support stand	30.0	1	070690X
Workbench installer, 1200x550x835 mm			
RO BP18/4, 4.0Ah 18V Li-Power battery	0.66	1	100001653
RO BP18/4, 4.0Ah 18V Li-HD battery	0.59	1	100002548
RO BP18/8, 8.0Ah 18V Li-HD battery	0.98	1	100002549
RO BC14/36 battery charger, 230V, EU	0.58	1	100001654

¹⁾ Complete terms and conditions at rothenberger.com/roservice
RO SERVICE+ only valid in participating countries

²⁾ More information at cordless-alliance-system.com

Cutting

Deburring, chamfering and calibration

1 Universal internal and external deburrer

Quick and easy deburring $\varnothing 4 - 54 \text{ mm}$ (1/8 - 2")

For copper, steel and stainless steel pipes, with polished cutting blade made of hardened special steel; smooth running






No. 11006



No. 150000237



No. 150000236

Model	 mm	 inch	 g	No.
Internal and external deburrer for copper and plastic	4 - 36	1/8 - 1.3/8"	30	11006
Internal and external deburrer for copper and INOX (stainless steel)	6 - 35	1/4 - 1.3/8"	100	150000237
Internal and external deburrer for copper and INOX (stainless steel)	10 - 54	1/2 - 2"	390	150000236

Deburrer adaptor I/II

Adaptor for the use of the internal and external deburring with portable screwdriver or drill

Best deburring results at low speed, 800 rpm at the most!

Product profile

KEY FEATURES

- User-friendly solution for deburring pipes "internal and external"
- Saves time
- Precise, burr-free deburring without effort



No. 11045



No. 11044

Drive shaft

For the deburring with portable screwdriver or drill



Model	g	No.
Deburrer adaptor I for No. 150000237	160	11044
Deburrer adaptor II for No. 150000236	280	11045

Cutting

Deburring, chamfering and calibration

1 GRATFIX HSS / UNIGRAT

Deburrer

KEY FEATURES

- Replaceable blades
- GRATFIX with plastic cartridge grip
- Grip recess is raised at the end and prevents the tool from slipping out of users' hands
- One-handed use with the retractable locking head
- Offset surfaces provide a good torque
- Pluggable handle ends for the storage of associated blades

Ideal for deburring of edges, pipes and steel, aluminium, brass, copper sheets, cast iron and plastic plates!





UNIGRAT (No. 21660)



GRATFIX HSS (No. 21655)



Nr. 1 (No. 21652)

Model	 g		No.
UNIGRAT with HSS deburring blade	30	10	21660
GRATFIX with deburring blade No. 1	50		21655
GRATFIX with deburring blade No. 1 - 2 - 3	80		21651
HSS deburring blade No. 1 Universal	10	10	21652



ROGRAT MLP deburrer and chamfering tool

For internal and external deburring, chamfering, calibrating and custom milling of PE-X and aluminium multi-layer (MLP) pipes of up to Ø 26 mm

KEY FEATURES

- Internal and external deburrer for PE-X and aluminium multilayer pipes (MLP) through chamfering to approved standards
- Simultaneous chamfering
- Calibration of the pipe ends through a special guiding pin

One tool with three functions: chamfering, calibrating and deburring!



Star handle with screw-bit attachment and quick locking mechanism

High force transmission

True to size guiding and calibration pin

Increased safety, protects O-ring from damage

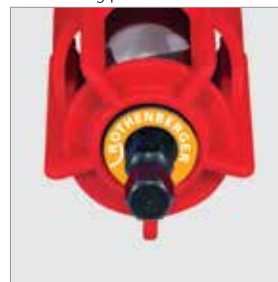
Shock-resistant protective sleeve

Protects from injury

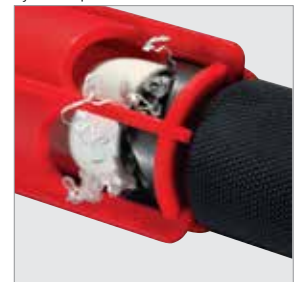


Fig. ROGRAT MLP deburrer set

Color coding prevents confusion



System optimised chamfer



ROGRAT MLP system - manual chamfering attachments

Set includes: carrying case (No. 14005), with basic handle grip (No. 14000) and system-manual chamfering attachments

ROGRAT type	Press system	Pipe measurement mm	Color code	g	No.
TH 16	Henco / MHS	16.0 x 2.00	●	53	14122
TH 26		26.0 x 3.00	●	108	14126

Model	For size mm	g	No.
TH Henco/HMS	16 - 20 - 26	760	14250
Basic handle		250	14000



RODIA

diamond core drilling

System overview	38 - 39
Characteristics diamond drill bits	40
Hand-operated drilling	
Wet drilling machine	41
Hand-operated and stationary drilling	
Wet drilling machine	43
Diamond wet and dry drilling system	42 - 47
Diamond drill bits	
Wet cutting drill bits for natural stone, soldered	48
Wet and dry cutting drill bits, space welding	49 - 50
Accessories for hand-operated and stationary drilling	
Vacuum pump systems	51
Accessories diamond core drilling	51 - 53
Extraction systems	
Wet and dry extraction unit	53

RODIA diamond core drilling

System overview

2

Hand-operated drilling



	Hand-operated	Hand-operated	Hand-operated	Hand-operated / stationary
Stationary drilling in concrete:	Ø 6 - 67 mm	Ø 10 - 132 mm	Ø 10 - 200 mm	Ø 10 - 132 mm
Stationary drilling in masonry:	Ø 6 - 67 mm	Ø 32 - 162 mm	Ø 32 - 225 mm	Ø 10 - 152 mm
Hand-operated drilling in concrete:	Ø 6 - 35 mm	Ø 10 - 82 mm	Ø 10 - 82 mm	Ø 10 - 82 mm
Hand-operated drilling in masonry:	Ø 6 - 67 mm	Ø 32 - 162 mm	Ø 32 - 250 mm	Ø 32 - 162 mm
Power output:	800 W	1,400 W	2,400 W	1,400 W
Speed transmission:	2-gear	2-gear	3-gear	2-gear
Nominal speed:	3,600 / 6,400 rpm	500 / 1,050 rpm	600 / 1,250 / 3,200 rpm	500 / 1,050 rpm
Torque:	4 / 7 Nm	55 / 27 Nm	71 / 34 / 17 Nm	55 / 27 Nm
Weight:	3.4 kg	6.7 kg	7.2 kg	16.7 kg
Page	41	43	43, 45	42

Drill bits



	High SPEED Plus-natural stone*	DX- High SPEED Plus*	SPEED STAR DX*
Connection:	G 1/2"	G 1/2", 1.1/4" UNC	G 1/2", 1.1/4" UNC
Drill bit diameter:	Ø 6 - 67 mm	Ø 20 - 300 mm	Ø 10 - 500 mm
Working length:	up to Ø 10 mm = 50 mm from Ø 12 mm = 120 mm	G 1/2", 400 mm working length 1.1/4" UNC, 430 mm working length	G 1/2", 400 mm working length 1.1/4" UNC, 430 mm working length
Application:	wet	wet and dry	wet and dry
Tiles:	☺☺☺	☺	☺☺
Granite:	☺☺☺	☺	☺☺
Marble:	☺☺☺	☺	☺☺
Brick:	☺☺	☺☺☺**	☺☺☺**
Masonry:	☺	☺☺☺**	☺☺**
Lime-sand brick:	☺	☺☺☺**	☺☺**
Asphalt:	☺☺	☺☺☺**	☺☺☺**
Screed:	☺☺	☺☺☺	☺☺
Concrete:	☺☺☺	☺☺☺	☺☺
Reinforced concrete:	☺☺☺	☺☺	☺☺☺
Page	48	49	50

* Special lengths and diameters on request, ** Suitable for dry drilling, ☺☺☺ Ideally suited ☺☺ Very suitable ☺ Suitable

Stationary drilling

**RODIACUT 150,
RODIADRILL 200**



**RODIACUT 250,
RODIADRILL 200**



**RODIACUT 250,
RODIADRILL 500**



**RODIACUT 400 PRO,
RODIADRILL 500**



	Hand-operated / stationary	Hand-operated / stationary	Stationary	Stationary
Stationary drilling in concrete:	Ø 10 - 152 mm	Ø 10 - 200 mm	Ø 32 - 250 mm	Ø 32 - 400* (500) mm
Stationary drilling in masonry:	Ø 10 - 152 mm	Ø 32 - 225 mm	Ø 32 - 250 mm	Ø 32 - 400* (500) mm
Hand-operated drilling in concrete:	Ø 10 - 82 mm	Ø 10 - 82 mm		
Hand-operated drilling in masonry:	Ø 32 - 250 mm	Ø 32 - 250 mm		
Power output:	2,400 W	2,400 W	3,000 W	3,000 W
Speed transmission:	3-gear	3-gear	3-gear	3-gear
Nominal speed:	600 / 1,250 / 3,200 rpm	600 / 1,250 / 3,200 rpm	215 / 430 / 785 rpm	215 / 430 / 785 rpm
Torque:	71 / 34 / 17 Nm	71 / 34 / 17 Nm	185 / 107 / 55 Nm	185 / 107 / 55 Nm
Weight:	17.2 kg	25.2 kg	30.1 kg	39.8 kg

Page

42

44

44

46

* Drilling range with distance plate expandable up to 500 mm

RODIA diamond core drilling

Characteristics diamond drill bits

Space welding

Cold welding process according to cutting-edge bonding technology: Due to the "neutral zone" the entire diamond segment is used without waste.

SPACE WELDING

Wet and dry drilling with new technology:

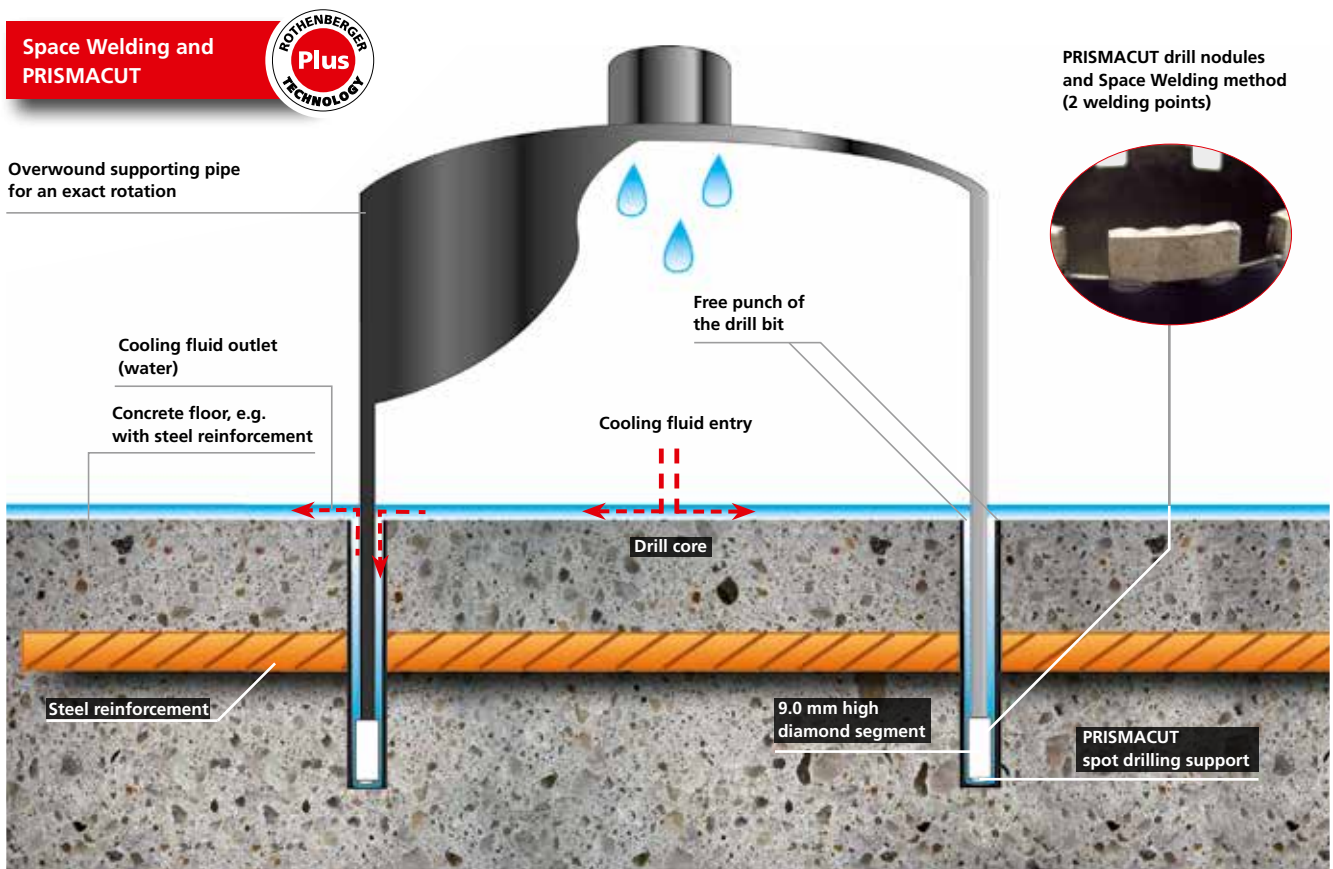
- The innovative high-performance drill bit DURAMANT PRO and SPEED STAR DX is produced using cutting-edge welding technology
- Because of the neutral zone, the "Space welding" cold welding process guarantees the optimum use of the complete diamond segments without loss
- The service life is up to 20% higher compared to lasered and soldered drill bits

PRISMACUT

Four drill nodules on the diamond segment improve the drill behaviour and at the same time provides optimum water cooling.

PRISMACUT

- The exceptional segment positioning offers optimum free punch size and an excellent cutting speed
- The "PRISMACUT" centre drill nodule is characterised by a better drill behaviour and preservation of the diamond segment
- PRISMACUT guarantees direct water cooling of the diamond segments
- 15% higher cutting speed with steel reinforcement



DX High Speed Plus universal drill bits

Space welding universal wet and dry drill bits for Ø 10 - 300 mm



DX-HIGH SPEED PLUS
universal drill bits on
page 47

SPEED STAR DX

Space welding wet and dry drill bits for different diameters in the range of 10 - 500 mm



SPEED STAR DX
drill bits on page 48

RODIA diamond core drilling

Hand-operated and stationary drilling

RODIADRILL Ceramic

Hand-operated wet drilling, drill Ø 6 - 67 mm

Ideally suited for HVAC&R, plumbing professionals, tilers, stair builders, remodelling specialists as well as electricians. Everywhere where jolt-free operation is necessary and extremely hard materials need to be processed.



2

Product profile

APPLICATION AREA

Hand-operated wet drilling in:

(reinforced) concrete Ø 6 - 35 mm, marble, granite, ceramic tiles, masonry, hollow brickwork and glass Ø 6 - 67 mm

KEY FEATURES

- For all common G 1/2" drill bits
- Fatigue-free operation with the lightweight
- Also drills through material combinations (for example tiles + masonry) without damaging material or surfaces and without cumbersome tool change
- "Aqua-stop button" with quantity adjustment
- Ideal for serial drilling with the external water supply
- Toolless exchange of the drill bits with the Quick change system
- Integrated 1 litre water tank for 4 - 6 drill holes

TECHNICAL DATA

2-speed transmission:	1. gear speed	2. gear speed
Nominal speed:	3,600 rpm	6,400 rpm
Drilling range in mm:	Ø 25 - 67	Ø 6 - 25
Voltage:	230 V	
Power input/output:	1,150 W / 800 W	
Charging rate:	3.6 A	
Maximum drilling depth:	400 mm (depending on material)	
Minimum distance to wall:	30 mm from drill hole center	
Minimum distance to corner:	30 mm from drill hole center	
Weight:	3.4 kg	

Integrated 1 litre water tank

Sufficient supply for 4 - 6 drill holes and can be rotated when working in confined spaces

Quick change system drill bit adaptor

Toolless quick change for G 1/2" drill bits

Connection for external water supply

Ideal solution for serial drillings

11-part set (No. FF40150) includes: drill motor RODIADRILL Ceramic (No. FF40150), 1 high speed plus drill bit each Ø 6 - 8 - 10 mm (No. FF44806, FF44808, FF44810), 3 x quick change adapter (No. FF35751), spanners sizes 24 and 27 (No. FF70024, FF70027), hexagonal key (No. 321523), ROCASE 6414 (No. 1300003336), ROCASE inlay (No. 1300005582)



"Aqua-stop button" – water pressure valve with quantity adjustment

Perfectly regulated flow of the water quantity

Model	kg	No.
RODIADRILL Ceramic set	3.4	FF40150

ACCESSORIES



Model	No.	Model	No.
Quick change adaptor	FF35751	Water supply hose with "aqua-stop"	FF35302
Pressurized water container 10 l	52	HSP Nature stone drill bits	48
Special water supply hose	FF35301	Water collection ring, stationary	52
			FF35700

¹⁾ Complete terms and conditions at rothenberger.com/roservice
RO SERVICE+ only valid in participating countries

RODIA diamond core drilling

Hand-operated and stationary drilling

RODIACUT 150 / RODIADRILL 160

RODIACUT 150 drill stand with combination drill mounting plate and RODIADRILL 160 drill motor for drilling \varnothing 10 - 132 mm (\varnothing 162 mm) in reinforced concrete

Product profile

APPLICATION AREA

RODIADRILL 160:

Stationary wet drilling in (reinforced) concrete: \varnothing 10 - 132 mm
 Hand-operated wet drilling in (reinforced) concrete: \varnothing 10 - 82 mm
 Hand-operated dry drilling in masonry: \varnothing 10 - 162 mm

TECHNICAL DATA (DRILL STAND)

RODIACUT 150:

Drilling range: Without water collection ring max. \varnothing 152 mm
 With water collection ring max. \varnothing 132 mm

Drill motor adaptor:

\varnothing 60 mm

L x W x H:

280 x 440 x 810 mm

Hub:

480 mm

Weight:

9.7 kg

3 applications with just one unit



RODIACUT 150 / RODIADRILL 200

RODIACUT 150 drill stand with combination drill mounting plate and RODIADRILL 200 drill motor for drilling \varnothing 10 - 152 mm (\varnothing 250 mm) in reinforced concrete

Product profile

APPLICATION AREA

RODIADRILL 200:

Stationary wet drilling in (reinforced) concrete: \varnothing 10 - 132 mm
 Hand-operated wet drilling in (reinforced) concrete: \varnothing 10 - 82 mm
 Hand-operated dry drilling in masonry: \varnothing 10 - 162 mm

3 applications with just one unit



RODIA diamond core drilling

Hand-operated and stationary drilling

RODIADRILL 160

Drill motor



TECHNICAL DATA (DRILL MOTOR)

Drill motor:	RODIADRILL 160	
Threaded adaptor:	G 1/2" and 1.1/4" UNC	
Power input / output:	2,000 W / 1,400 W	
2-speed-transmission:	1. gear	2. gear
Nominal speed:	500 rpm	1,050 rpm
Torque:	55 Nm	27 Nm
Clamping neck:	Ø 60 mm	

RODIADRILL 200

Drill motor



TECHNICAL DATA (DRILL MOTOR)

Drill motor:	RODIADRILL 200		
Threaded adaptor:	G 1/2" and 1.1/4" UNC		
Power input / output:	2,700 W / 2,400 W		
3-speed transmission:	1. gear	2. gear	3. gear
Nominal speed:	600 rpm	1,250 rpm	3,200 rpm
Torque:	71 Nm	34 Nm	17 Nm
Clamping neck:	Ø 60 mm		



Set (No. FF34150) includes: Drill stand RODIACUT 150 (No. FF30150), drill motor RODIADRILL 160 (No. FF40165), tool bag (No. FF70001), spanner SW19 DIN895 (No. FF70019N), spanner SW24 DIN894 (No. FF70024), spanner SW36 DIN894 (No. FF70036), spanner SW41 DIN894 (No. FF70041), concrete fixing set (No. FF35120), water supply hose + adaptor for Gardena coupling (No. FF35302), hammer drill SDS Plus 15x160mm (No. 111429), copper ring 1.1/4" (No. FF35190), instruction manual drill stand RODIACUT 150-250 (No. 1300002467), instruction manual RODIADRILL 160+200 (No. 1300002468), earplugs SaveRave (No.410000439), rubberized gloves (No.410000443), safety goggle HC/AF (No. 410000441)

Set (No. FF34160) includes: Drill stand RODIACUT 150 (No. FF30150), drill motor RODIADRILL 200 (No. FF40220), tool bag (No. FF70001), spanner SW19 DIN895 (No. FF70019N), spanner SW24 DIN894 (No. FF70024), spanner SW36 DIN894 (No. FF70036), spanner SW41 DIN894 (No. FF70041), concrete fixing set (No. FF35120), water supply hose + adaptor for Gardena coupling (No. FF35302), hammer drill SDS Plus 15x160mm (No. 111429), copper ring 1.1/4" (No. FF35190), instruction manual drill stand RODIACUT 150-250 (No. 1300002467), instruction manual RODIADRILL 160+200 (No. 1300002468), earplugs SaveRave (No. 410000439), rubberized gloves (No. 410000443), safety goggle HC/AF (No. 410000441)

Model	kg	No.
Drill system RODIACUT 150/RODIADRILL 160	16.5	FF34150
Drill stand RODIACUT 150	9.7	FF30150
Drill motor RODIADRILL 160	6.8	FF40165
Drill system RODIACUT 150/RODIADRILL 200	16.9	FF34160
Drill motor RODIADRILL 200	7.2	FF40220

ACCESSORIES



Model	No.	Model	No.
RODIADRILL Ceramic	41 FF40150	RODIA DRY CLEANER 1600	53 FF35144
Pressurized water container 10 l	52 FF35028	Water collection ring, stationary (for No. FF30150)	52 FF35700
Vacuum pump RODIA-VAC	51 FF35200	Drill bits	48 - 50

¹⁾ Complete terms and conditions at rothenberger.com/roservice
RO SERVICE+ only valid in participating countries

RODIA diamond core drilling

Hand-operated and stationary drilling

RODIACUT 250 / RODIADRILL 200

RODIACUT 250 drill stand with combination drill mounting plate and RODIADRILL 200 drill motor for drilling \varnothing 10 - 200 mm (\varnothing 250 mm) in reinforced concrete

Product profile

APPLICATION AREA

RODIADRILL 200:

Stationary wet drilling in reinforced concrete:	\varnothing 10 - 200 mm
Stationary dry drilling in masonry:	\varnothing 10 - 225 mm
Hand-operated wet drilling in reinforced concrete:	\varnothing 10 - 82 mm
Hand-operated dry drilling in masonry:	\varnothing 10 - 250 mm

TECHNICAL DATA (DRILL STAND)

RODIACUT 250:

Drilling range: Without water collection ring max. \varnothing 250 mm
With water collection ring max. \varnothing 225 mm

Drill motor-adaptor:

Clamping neck \varnothing 60 mm and quick change recording via dovetail plate

L x W x H: 260 x 510 x 980 mm

Hub: 650 mm

Weight: 19.7 kg

4 applications with just one unit

Hexagon socket screw key 6 mm included

All adjustments with a single tool

Feed unit with quick change uptake

Toolless, quick mounting/demounting of drill motor

Adjustable handle

Quick change of operating side-drilling, even in confined spaces



RODIACUT 250 / RODIADRILL 500

RODIACUT 250 drill stand with combination drill mounting plate and RODIADRILL 500 drill motor for drilling \varnothing 10 - 250 mm in reinforced concrete

Product profile

APPLICATION AREA

RODIADRILL 500:

Stationary dry drilling in reinforced concrete:	\varnothing 32 - 250 mm
Stationary dry drilling in masonry:	\varnothing 32 - 250 mm

2 applications with just one unit

Buckling resistant column

Robust and lightweight



Integrated vacuum plate

Two mounting options with just one base plate



RODIA diamond core drilling

Hand-operated and stationary drilling

RODIADRILL 200

Drill motor



TECHNICAL DATA (DRILL MOTOR)

Drill motor:	RODIADRILL 200
Threaded adaptor:	G 1/2" and 1.1/4" UNC
Power input / output:	2,700 W / 2,400 W
3-speed transmission:	1. gear 2. gear 3. gear
Nominal speed:	600 rpm 1,250 rpm 3,200 rpm
Torque:	71 Nm 34 Nm 17 Nm
Clamping neck:	Ø 60 mm

RODIADRILL 500

Drill motor



TECHNICAL DATA (DRILL MOTOR)

Drill motor:	RODIADRILL 500
Threaded adaptor:	G 1/2" and 1.1/4" UNC
Power input / output:	4,000 W / 3,000 W
3-speed transmission:	1. gear 2. gear 3. gear
Nominal speed:	215 rpm 430 rpm 785 rpm
Torque:	185 Nm 107 Nm 55 Nm
Drill motor adaptor:	Quick-change recording via dovetail plate



Set (No. FF34200) includes: drill stand RODIACUT 250 (No. FF30250), drill motor RODIADRILL 200 (No. FF40220), tool bag (No. FF70001), spanner SW19 DIN895 (No. FF70019N), spanner SW24 DIN894 (No. FF70024), spanner SW36 DIN894 (No. FF70036), spanner SW41 DIN894 (No. FF70041), concrete fixing-set (No. FF35120), water supply hose + adaptor for Gardena coupling (No. FF35302), hammer drill SDS Plus 15x160mm (No. 111429), copper ring 1.1/4" (No. FF35190), instruction manual drill stand RODIACUT 150-250 (No. 1300002467), instruction manual RODIADRILL 160+200 (No. 1300002468), earplugs SaveRave (No. 4100000439), rubberized gloves (No. 4100000443), safety goggle HC/AF (No. 4100000441)

Set (No. FF34260) includes: drill stand RODIACUT 150 (No. FF30250), drill motor RODIADRILL 500 (No. FF40400), tool bag (No. FF70001), spanner SW19 DIN895 (No. FF70019N), spanner SW24 DIN894 (No. FF70024), spanner SW32 DIN894 (No. FF70032), spanner SW41 DIN894 (No. FF70041), concrete fixing-set (No. FF35120), water supply hose + adaptor for Gardena coupling (No. FF35302), hammer drill SDS Plus 15x160mm (No. 111429), copper ring 1.1/4" (No. FF35190), instruction manual drill stand RODIACUT 150-250 (No. 1300002467), instruction manual RODIADRILL 500 (No. 1300002469), earplugs SaveRave (No. 4100000439), rubberized gloves (No. 4100000443), safety goggle HC/AF (No. 4100000441)

Model	kg	No.
Drill system RODIACUT 250/RODIADRILL 200	21.7	FF34200
Drill stand RODIACUT 250	14.5	FF30250
Drill motor RODIADRILL 200	7.2	FF40220
Drill system RODIACUT 250/RODIADRILL 500	31.4	FF34260
Drill motor RODIADRILL 500	12.1	FF40400

ACCESSORIES



Model	No.	Model	No.
RODIADRILL Ceramic	41 FF40150	RODIA DRY CLEANER 1600	53 FF35144
Pressurized water container 10 l	52 FF35028	Water collection ring, stationary (for No. FF30150)	52 FF35700
Vacuum pump RODIA-VAC	51 FF35200	Drill bits	48 - 50

¹⁾ Complete terms and conditions at rothenberger.com/roservice
RO SERVICE+ only valid in participating countries

RODIA diamond core drilling

Stationary drilling

RODIACUT 400 PRO / RODIADRILL 500

RODIACUT 400 drill stand with dowel plate and RODIADRILL 500 for drilling \varnothing 32 - 400 (500)* mm in reinforced concrete



2

Product profile

APPLICATION AREA

2 applications in one unit:

Stationary wet drilling in (reinforced) concrete \varnothing 32 - 400* mm
Stationary dry drilling in masonry \varnothing 32 - 400* mm

KEY FEATURES

- Drill angle adjustments from -15° up to $+45^\circ$, in 2.5° steps adjustable
- Exchangeable guide rail

TECHNICAL DATA (DRILL STAND)

Drilling range: W/o water collection ring: max. \varnothing 400 mm
Optional with distance plate max. \varnothing 500 mm
Weight: 28.4 kg
L x W x H: 460 x 260 x 1,100 mm
Hub: 680 mm



4x roll guides

Precise and low vibration operation, flexible use / module concept

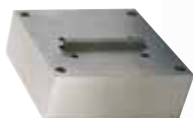


Drill angle adjustments

Adjustable from -15° up to $+45^\circ$ in 2.5° steps

Rubber transport wheels

Quick and easy transport on the building site



*Distance plate optional (No. FF35136)

To enlarge the drill hole diameter from \varnothing 400 to 500 mm with RODIACUT 400 PRO





RODIADRILL 500


Drill motor



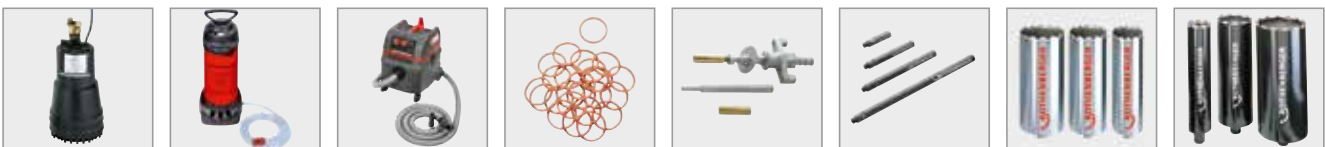
Set (No. FF34500) includes: drill stand RODIACUT 400 PRO (No. FF30030), drill motor RODIADRILL 500 (No. FF40400), tool bag (No. FF70001), spanner SW19 DIN895 (No. FF70019N), spanner SW24 DIN894 (No. FF70024), spanner SW32 DIN894 (No. FF70032), spanner SW41 DIN894 (No. FF70041), concrete fixing-set (No. FF35120), water supply hose + adaptor for Gardena coupling (No. FF35302), hammer drill SDS Plus 15x160mm (No. 111429), copper ring 1.1/4" (No. FF35190), instruction manual drill stand RODIACUT 400 PRO (No. 1300002467), instruction manual RODIADRILL 500 (No. 1300002468), earplugs SaveRave (No. 4100000439), rubberized gloves (No. 4100000443), safety goggles HC/AF (No. 4100000441)



TECHNICAL DATA (DRILL MOTOR)

Drill motor:	RODIADRILL 500
Threaded adaptor:	G 1/2" and 1.1/4" UNC
Power input / output:	4,000 W / 3,000 W
3-speed transmission:	1. gear 2. gear 3. gear
Nominal speed:	215 rpm 430 rpm 785 rpm
Torque:	185 Nm 107 Nm 55 Nm
Drill motor adaptor:	Dovetail plate

Model	 kg	No.
Drill system RODIACUT 400 PRO / RODIADRILL 500	40.5	FF34500
Drill stand RODIACUT 400 PRO	28.4	FF30030
Drill motor RODIADRILL 500	12.1	FF40400

ACCESSORIES



Model	 No.	Model	 No.
Submersible water pump RODIAPUMP	52 FF35029	Drill bits	48 - 50
Pressurized water container 10 l	52 FF35028	Distance plate 60 mm	FF35136
RODIA DRY CLEANER 1600	53 FF35144	Copper rings 1.1/4"	51 FF35190
Mounting articles	51	Extensions	52

RODIA diamond core drilling

Diamond-drill bits

High Speed Plus natural stone

Soldered diamond core wet cutting drill bit between Ø 6 - 67 mm for extremely hard materials

Suitable for all other drilling systems with G 1/2" and 1.1/4" UNC!



2

Product profile

APPLICATION AREA

Special wet drill bits for drilling in natural stone, granite, marble, (double) baked brick, masonry, (reinforced) concrete, glass or hollow brickwork from Ø 6 - 67 mm

Typical areas of application are HVAC&R, plumbing and electronic installations, old building renovations, laying tile, stairs and railing installation, air-conditioning technology, garden and landscaping

KEY FEATURES

- Extremely easy cuts, very long service life through 9 mm high segments
- Suitable for all ROTHENBERGER drilling machines
- Balanced rotation reduces wear
- Drilling even through material combinations possible

KEY FEATURES

- Drill holes on the seam or edge of material possible with the use of diamond rings
- Conventional G 1/2" threaded attachments

TECHNICAL DATA

G 1/2" adaptor

Drill bits	Segment	Segment dimensions (L x W x H)
Ø 6 - 40 mm	Ring segments	Ring x (1.15 - 2.0) x 9 mm
Ø 45 - 67 mm*	4 - 6	24 x 2.5 x 8 mm
Effective length:	Ø 6.3 - 10 mm = 50 mm	
	Ø 12 - 67 mm = 120 mm	
	Special length of 300 mm available upon request	

*Single segment mounting from Ø 45 mm

9 mm high segments with high diamond concentration

Extremely easy cutting, very long service life in granite tiles

Threaded adaptor G 1/2"

Suitable for all other ROTHENBERGER drilling machines



Overwound drill bits

Balanced rotation reduces wear

Drilling of the hardest materials



Reinf. concrete



Marble



Granite



Green granite



Masonry



Hollow brickwork



Aerated concrete



Asphalt



Suitable for



RD 160



Ceramic



RD 200

Ø mm	kg	Adaptor G 1/2" No.	Ø mm	kg	Adaptor G 1/2" No.	Ø mm	kg	Adaptor G 1/2" No.	Ø mm	kg	Adaptor G 1/2" No.
6.3	0.17	FF44806	15	0.20	FF44815	30	0.25	FF44830	67*	0.79	FF44867
8.3	0.17	FF44808	16	0.20	FF44816	35	0.30	FF44835			
10	0.17	FF44810	20	0.22	FF44820	40	0.34	FF44840			
12	0.19	FF44812	22	0.22	FF44822	50*	0.60	FF44850			
14	0.20	FF44814	24	0.22	FF44824	60*	0.72	FF44860			

* with single segment mounting

DX High Speed Plus universal drill bits

Space welding universal wet and dry drill bits
Ø 20 - 300 mm

Space Welding and
PRISMACUT



Product profile

APPLICATION AREA

Wet and dry drill bits for drilling in reinforced concrete, asphalt, masonry as well as lime sand brick for Ø 20 - 300 mm

Typical areas of application are HVAC&R and electronic installations, old building renovations, building industry, air-conditioning technology, garden and landscaping

KEY FEATURES

- Extremely easy cutting, safe cut in hand-operated use
- Faster cutting progress and extremely long service life
- Suitable for all other ROTHENBERGER drilling machines
- Balanced rotation reduces wear

Suitable for



RD 160*



RD 200*



RD 500*

We recommend the optional extraction rotor when using as a dry drill bit

Highest service life and universal application!

Marble



Masonry



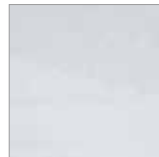
Hollow brickwork



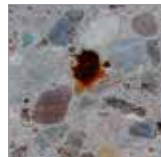
Pavement



Lime sand brick



Reinf. concrete



Threaded adaptor G 1/2" and 1.1/4" UNC

Suitable for all other ROTHENBERGER drilling machines



Space welding

Allows wet and dry use

Overwound drill bits

Balanced rotation reduces wear

TECHNICAL DATA

G 1/2" connection (300 mm effective length)

Drill bits	Segment	Segment dimensions (L x W x H)
Ø 20 - 40 mm	1	19.3 x 2.5 x 9 mm
Ø 42 - 62 mm	4 - 6	24.0 x 2.5 x 9 mm
Ø 72 - 92 mm	7 - 8	24.0 x 2.8 x 9 mm
Ø 102 - 132 mm	7 - 11	24.0 x 3.3 x 9 mm

1.1/4" UNC connection (430 mm effective length)

Ø 30 - 62 mm	1 - 6	24.0 x 2.5 x 9 mm
Ø 72 - 92 mm	7 - 8	24.0 x 2.8 x 9 mm
Ø 102 - 152 mm	9 - 12	24.0 x 3.3 x 9 mm
Ø 162 - 182 mm	12 - 14	24.0 x 3.8 x 9 mm
Ø 200 - 300 mm	14 - 20	24.0 x 4.0 x 9 mm

Special segment mix

Quicker drilling progress and extremely long service life

Extremely easy cuts, safe cuts in hand operated use



Ø mm	kg	Adaptor G 1/2" No.
20	0.5	FF44620
30	0.6	FF44630
40	0.7	FF44640
52	0.9	FF44650
62	1.2	FF44660
72	1.4	FF44670

Ø mm	kg	Adaptor G 1/2" No.
82	1.6	FF44680
92	1.9	FF44690
102	2.1	FF44700
112	2.4	FF44710
122	2.6	FF44720
132	2.9	FF44730

Ø mm	kg	Adaptor 1.1/4" No.
30	0.7	FF44030
40	1.2	FF44040
52	1.6	FF44050
62	1.9	FF44060
72	2.3	FF44070
82	2.6	FF44080
92	3.0	FF44090
102	3.4	FF44100
112	3.8	FF44110
122	4.2	FF44120

Ø mm	kg	Adaptor 1.1/4" No.
132	4.6	FF44130
142	5.0	FF44140
152	6.4	FF44150
162	7.0	FF44160
172	7.5	FF44170
182	8.0	FF44180
200	9.0	FF44200
220	11.4	FF44220
250	13.6	FF44250
300	19.3	FF44300

Suitable for all other drilling systems with G 1/2" and 1.1/4" UNC!

RODIA diamond core drilling

Diamond-drill bits

SPEED STAR DX

Space welding wet and dry drill bits between
Ø 10 - 500 mm

Space welding and
PRISMACUT



2

Product profile

APPLICATION AREA

Wet and dry drill bits for asphalt, masonry as well as natural and artificial stone between Ø 10 - 500 mm

Typical areas of application are HVAC&R, plumbing, old building renovations, building industry, air-conditioning technology, gardening and landscaping

KEY FEATURES

- Extremely easy cuts, safe cut in hand-operated use
- Balanced rotation reduces wear
- Suitable for all other ROTHENBERGER drilling machines
- Standard lengths 400 / 500 mm, special lengths available on request
- Conventional G 1/2" and 1.1/4" UNC threaded adaptors

TECHNICAL DATA

Drill bits	Segment	Segment dimensions (L x W x H)
Ø 10 - 38 mm	1	16 x 3.0 x 7.0 mm
Ø 40 - 48 mm	1 - 4	24 x 3.0 x 9.0 mm
Ø 50 - 55 mm	5 - 6	24 x 3.5 x 9.0 mm
Ø 56 - 72 mm	6 - 7	24 x 3.5 x 9.0 mm
Ø 75 - 102 mm	7 - 8	24 x 3.5 x 9.0 mm
Ø 107 - 142 mm	9 - 11	24 x 4.0 x 9.0 mm
Ø 142 - 182 mm	11 - 14	24 x 4.0 x 9.0 mm
Ø 182 - 250 mm	14 - 16	24 x 4.0 x 9.0 mm
Ø 300 - 500 mm	16 - 26	20 x 5.0 x 9.0 mm
Connection G 1/2":		Effective length 400 mm
Connection 1.1/4" UNC:		Effective length 430 mm



Suitable for



Special drill bits for asphalt, pavement as well as special lengths up to 1000 mm available upon request !

* We recommend the optional extraction rotor when used as a dry drill bit



Ø mm	kg	Adaptor G 1/2" No.	Ø mm	kg	Adaptor G 1/2" No.	Ø mm	kg	Adaptor 1.1/4" No.	Ø mm	kg	Adaptor 1.1/4" No.
10	0.3	FF00610	56	1.2	FF00655	25	0.6	FF00025	132	4.6	FF00130
12	0.4	FF00612	66	1.3	FF00665	30	0.7	FF00030	142	5.0	FF00140
16	0.4	FF00616	76	1.5	FF00675	46	1.4	FF00045	152	6.4	FF00150
18	0.4	FF00618	82	1.6	FF00680	52	1.6	FF00050	162	7.0	FF00160
20	0.5	FF00620	102	2.1	FF00700	56	1.7	FF00055	200	9.0	FF00200
25	0.5	FF00625	112	2.4	FF00710	66	2.1	FF00065	250	13.6	FF00250
32	0.6	FF00632	132	2.9	FF00730	76	2.4	FF00075	280	17.6	FF00280
40	0.7	FF00640				102	3.4	FF00100	300	19.3	FF00300
46	0.7	FF00645				112	3.8	FF00110	350	23.6	FF00350
52	0.9	FF00650				122	4.2	FF00120	500	39.1	FF00500

RODIA diamond core drilling

Accessories for hand-operated and stationary drilling

Vacuum pump RODIA-VAC

This vacuum pump is suitable for all diamond core drilling units. An extraction tank prevents the vacuum plate from loosening quickly during a sudden power failure. Oil-free vacuum pump with pressure gauge.



1.1 kW motor power
85% Vacuum
200 l/min extraction volume



10 l extraction tank

Safety during a power failure

Drill stand can only be mounted with a combination of vacuum plate and vacuum set!

Vacuum-sets

No. FF35710
No. FF35740



Quick clamping column

Toolless and reliable bracing between floor and wall or wall and wall. Maximum operation range from 1.7 m up to 3.0 m with a load capacity up to 500 kg with sideways guidance.



No. FF35015

Model	kg	No.
Quick clamping column	9.0	FF35015
Vacuum pump RODIA-VAC 230 V	20.0	FF35200
Vacuum set for RC 150/170 PRO-C	1.1	FF35710
Spare foamed rubber for drill base RC 150 etc.	0.1	FF50007
Vacuum set for RC 250/270 PRO-C	1.1	FF35740
Spare foamed rubber for drill base RC 250 etc.	0.1	FF50008

Concrete / masonry fixing set

Set (No. FF35120) includes: knurled thread rod type G-B 160 mm, screw thread M 12/20 mm (No. FF35129), U-washer (No. FF70166), winged nut M 12 (No. FF55150), 25 x drive-in anchor M 12 (No. FF35122) and drive-in iron (No. FF35128)

Set (No. FF35121) includes: knurled thread rod type G-M 280 mm, screw thread M 12/85 mm (No. FF35130), U-washer (No. FF70166), winged nut M 12 (No. FF55150), hexagonal nut M12 (No. FF70167), 5 x Rawl anchor M 12 (reusable) (No. FF35126) and drive-in iron (No. FF35128)



No. FF35120



No. FF35121

Thread interfaces

Between motor connection and drill bit



No. FF35095



No. FF35080



No. FF35091

Copper rings 1.1/4"

Levels out the unevenness between motor connection and drill bit. Easy loosening prevents drill bits from getting stuck on the driveshaft.



Special diamond drills for tiles and natural stone

For use when hammer drills can not do the job. Various material combinations, such as tiles on concrete, can be easily drilled without damage.

Special diamond drills

For tiles and natural stone



No. FF44815



No. FF44820

SDS-plus hammer drill



Model	kg	No.
Concrete fixing set	1.90	FF35120
Drive-in anchor concrete M12	0.04	FF35122
Threaded rod, B15 concrete set	0.20	FF35129
Threaded rod, B15 masonry	0.30	FF35130
SDS-plus hammer drill Ø 15 mm, wl. 160 mm	0.16	111429*
Wet drill bit Ø 15 mm, G1/2"	0.20	FF44815
Masonry fixing set	1.10	FF35121
Rawl anchor M 12	0.08	FF35126
Wet drill bit Ø 20 mm, G1/2"	0.22	FF44820
G 1/2" outer thread to 1.1/4"	0.50	FF35080
UNC outer thread		
1.1/4" UNC inner thread to G 1/2" inner thread	0.70	FF35095
Adaptor DD-BU to G 1/2" + 1.1/4"	0.80	FF35092
Adaptor DD-BL/BS/BR to G 1/2" + 1.1/4"	0.80	FF35093
Copper ring 1.1/4"	0.05	FF35190

* Cordless rotary hammer p. 333

¹⁾ Complete terms and conditions at rothenberger.com/roservice
RO SERVICE+ only valid in participating countries

RODIA diamond core drilling

Accessories for hand-operated and stationary drilling

Water supply

The sturdy 10 litre pressurized water container made of steel is perfectly suited for individual drilling. When drilling large diameters or series drillings, the fully submersible RODIAPUMP enables a mobile supply of water from buckets or other containers up to a delivery height of 5 meters using a 1" water hose.

2

Comfortable water connection

Quick connection with the GK adaptor and quick-plug coupling

Rust-free motor shaft

Prevents the quick jamming of the rotor

Fine filter

Prevents entry of foreign materials and protects the motor shaft

No. FF35029



Manometer

Pressure indicator

2.5 meter hose length

Ideal use for ceiling holes

No. FF35028



Connection quick plug-in coupling

Drip-free connection even under water pressure

Model	kg	No.
Water supply hose with Aqua-Stop	0.20	FF35302

Model	kg	No.
Pressurized water container, 10 litre	5.50	FF35028
Water supply hose for RODIADRILL	0.20	FF35301

Water extraction systems

The dirty cooling water is extracted in connection with a wet and dry vacuum (FF35144)



No. FF35730

Only for RODIACUT 202 DWS, 250 and 270 C



No. FF35700

Only for RODIACUT 131 DWS, 150 and 170 C

Model	kg	No.
Water collection ring, stationary (up to Ø 132 mm)	1.2	FF35700
Spare rubber membrane (for FF35700)	0.3	FF55131
Water collection ring, stationary (up to Ø 200 mm)	2.5	FF35730
Spare rubber membrane (for FF35730)	0.6	FF55201

Extensions for drill bits

G 1/2" and 1.1/4" UNC

- Easy extension of the drilling depth
- High-quality and robust steel design



Extensions G 1/2"



Extensions 1.1/4" UNC

Nominal length in mm	kg	G 1/2" No.	kg	1.1/4" UNC No.
100	0.40	FF35040	1.00	FF35060
200	0.90	FF35045	2.00	FF35065
300	1.40	FF35050	3.00	FF35070
500	2.40	FF35055	5.10	FF35075

Extraction rotor RODIADUST

Universal adaptor for wet drilling machines for dust-free dry drilling

Provides optimum extraction results in conjunction with RODIA DRY CLEANER (No. FF35144) and increases the drilling process, prevents jamming of drill bit and reduces segment wear.



Model	kg	No.
Extraction rotor (drill bit 1.1/4" UNC / motor G 1/2")	1.90	FF40056

RODIA DRY CLEANER 1600

Wet and dry extraction unit

Especially good performance when used with WALL CUT 6540, RODIADRILL 1800 DRY or other ROTHENBERGER extraction-friendly system products



**Constant extraction power!
Automatic filter-cleaning function!**



High cleaning efficiency

2 polyester-filter cassettes with 99.9% dust retention (max. 20 l), water retention of 15 litres

Separate automatic outlet

Adaptor for further electric tools

User comfort with a wide operating range

5 m long suction hose and 8 m long AC power cord



Fig. folded filter
No. FF55374

Model	kg	No.
RODIA DRY CLEANER 1600	10.8	FF35144
Folded filter (2 pcs.) for wet suction	1.0	FF55374
Fleece filter (5 pcs.) for dry suction	0.3	FF55388







Bending

System overview	56 - 57
Manual	
Bender one-handed	58 - 60
Bending pliers	61 - 62
Tube bending springs CU	63
Internal bending springs MLP	63
Vice bender	64 - 65
Manual hydraulic	
Bender, manual hydraulic	66 - 67
Electro-hydraulic	
Bender, electro-hydraulic	68 - 69
Electro	
Bender, electric	70 - 73
Bending tables	73 - 77

Bending

System overview

3

Push bending

TUBE BENDER



TUBE BENDER Maxi



TUBE BENDER Maxi MLP



Method:	Manual 90°	Manual 90°	Manual 90°
Working range: Copper	Ø 5 - 12 mm (1/4 - 1/2"), +Ø 1 mm, soft	Ø 12 - 22 mm (3/8 - 7/8") +Ø 1 mm, soft	–
Working range: Aluminium	Ø 5 - 12 mm (1/4 - 1/2"), +Ø 1 mm, soft	Ø 12 - 22 mm (3/8 - 7/8") +Ø 1 mm, soft	–
Working range: Precision steel	Ø 5 - 12 mm (1/4 - 1/2"), +Ø 1 mm, soft	Ø 12 - 22 mm (3/8 - 7/8") +Ø 1 mm, soft	–
Working range: Stainless steel	–	–	–
Working range: MLP	–	Ø 14 - 26 mm (5/8 - 7/8") +Ø 3 mm	Ø 14 - 32 mm +Ø 3 mm

Page

58

59

60

Pull bending

Standard two handed bender



MULTIBEND



MINIBEND



Standard bender



Method:	Manual 90°	Manual 180°	Manual 180°	Manual 180°
Working range: Copper	Ø 12 - 22 mm +Ø 1 mm, semi-hard	Ø 10 - 18 mm (1/4 - 5/8") +Ø 1 mm, soft	Ø 6 - 10 mm (1/4 - 3/8") +Ø 1 mm, soft	Ø 6 - 18 mm (1/4 - 5/8") +Ø 1 mm, soft
Working range: Aluminium	–	Ø 10 - 18 mm (1/4 - 5/8") +Ø 1 mm, soft	Ø 6 - 10 mm (1/4 - 3/8") +Ø 1 mm, soft	Ø 6 - 18 mm (1/4 - 5/8") +Ø 1 mm, soft
Working range: Precision steel	–	Ø 10 - 18 mm (1/4 - 5/8") +Ø 1 mm, soft	Ø 6 - 10 mm (1/4 - 3/8") +Ø 1 mm, soft	Ø 6 - 18 mm (1/4 - 5/8") +Ø 1 mm, soft
Working range: Stainless steel	–	–	–	–
Working range: MLP	–	–	–	–

Page

61

61

62

62

Push bending

ROBULL type E



ROBULL type ME



Method:	Manual hydraulic 90°	Electro-hydraulic 90°
Working range: Copper	–	–
Working range: Aluminium	–	–
Working range: Precision steel	Ø 3/8 - 2"	Ø 3/8 - 2"
Working range: Stainless steel	–	–
Working range: MLP	–	–

Page

66 - 67

68 - 69

Pull bending

Pro bender



**Internal bending
springs MLP**



ROBEND H+W PLUS



ROBEND 4000/4000E



Method:	Manual 180°	Manual 180°	Manual 180°	Electric 180°
Working range: Copper	Ø 10 - 16 mm (3/8 - 3/4") •⊖ 1 mm, soft, semi-hard, hard	–	Ø 8 - 22 mm (5/16 - 7/8") •⊖ 1 mm, soft, semi-hard, hard	Ø 12 - 35 mm (1/2 - 1.3/8") •⊖ 1.6 mm, soft, semi-hard, hard
Working range: Aluminium	–	–	Ø 8 - 22 mm (5/16 - 7/8") •⊖ 1 mm, soft	Ø 12 - 28 mm (1/2 - 1.1/8") •⊖ 2.0 mm, soft, semi-hard, hard
Working range: Precision steel	–	–	Ø 10 - 22 mm (3/8 - 5/8") •⊖ 1 mm, soft	Ø 12 - 28 mm (1/2 - 1.1/8") •⊖ 2 mm, soft
Working range: Stainless steel	Ø 10 - 16 mm (3/8 - 3/4") •⊖ 1 mm, soft, semi-hard, hard	–	Ø 8 - 22 mm (5/16 - 7/8") •⊖ 1 mm	Ø 12 - 28 mm (1/2 - 1.1/8") •⊖ 1.5 mm
Working range: MLP	–	Ø 6 - 20 mm	–	–

Page

61

63

64 - 65

70 - 71

Bending

Manual

TUBE BENDER

For accurate one-handed bending up to 90°,
Ø 5 - 12 mm (1/4 - 1/2")



Product Profile

APPLICATION AREA

Suitable for pipes made of:

Copper (soft) and aluminium:

Ø 5 - 12 mm, 1/4 - 1/2"

Precision steel (soft):

Ø 5 - 12 mm, 1/4 - 1/2"

KEY FEATURES

- Accurate bending even in restricted spaces
- Production of U-bends, counter bends, swan-neck bends and connecting bends possible at all levels
- Quick and simple change of the bending formers
- Fast release and removal of the bending formers
- One-handed operation through the ergonomic design
- Fast and accurate bending

3

Ratchet arm with bayonet coupling

Quick change of the bending formers

Release lever

Quick release and reset of the bending formers

Ergonomic design

One-handed operation

Compact design

Accurate bending even in restricted spaces

Mechanical ratchet feed

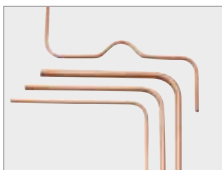
Quick and accurate bending

Open bending frame

Production of U-bends, counter bends, swan-neck bends and connecting bends possible at all levels



Various bends possible



TUBE BENDER
(No. 24130)



Bending formers (No. 24048)



Back plates (No. 24049)



Bending segments



TUBE BENDER sets include: basic tool complete with bending segments, back plates, ROCASE 4212 incl. inlay (No. 1300003334 + No. 1300004003)

Model	kg	No.
TB set 5 - 6 - 8 - 10 mm	2.84	24131
TB set 6 - 8 - 10 - 12 mm	3.03	24132
TB set 8 - 10 - 12 mm	2.82	24133
TB set 1/4 - 5/16 - 3/8 - 1/2"	2.92	24134
Basic tool without bending segments	0.36	766004016
Support segment	0.05	24048
Back plate without support segment	0.14	24049

TUBE BENDER bending segments

Model	Size	g	No.
Bending segment	5 mm	190	24001
Bending segment	6 mm	210	R2403200
Bending segment	8 mm	250	R2403300
Bending segment	9 mm	360	R2403400
Bending segment	10 mm	390	R2403500
Bending segment	12 mm	390	24007
Bending segment	1/4"	210	R2403200
Bending segment	5/16"	250	R2403300
Bending segment	3/8"	270	24006
Bending segment	1/2"	380	24008

Previous bending segments and back plates including support segments from earlier models are compatible!

TUBE BENDER MAXI

For accurate one-handed bending up to 90°,
Ø 12 - 26 mm (3/8 - 7/8")



Product Profile

APPLICATION AREA

For the bending of pipes made of soft copper and aluminium, coated copper and precision steel pipes as well as multilayered composite pipes.

Suitable for pipe made of:

Copper (soft) and aluminium:	Ø 10 - 22 mm, 3/8 - 7/8"
Copper (coated):	Ø 10 - 18 mm, 3/8 - 5/8"
Precision steel (soft):	Ø 10 - 22 mm, 3/8 - 7/8"
MLP (Multilayer):	Ø 14 - 26 mm, 5/8 - 7/8"

KEY FEATURES

- Eliminates the cost for bending formers, storage and purchase
- Quick release and reset of the bending segments
- Bending segments are easily exchanged
- Optimum bending results

3

Safe transport

Handle will not open during transport

Optimum bending results

Plastic bending segments and support segments with increased conductivity

Mechanical ratchet feed

Quick precise bending

Release lever

Quick release and reset of the bending former

Adjustable bending frame

Production of U-bends, counter bends, swan-neck bends and connecting bends possible at all levels



TUBE BENDER MAXI sets include: basic unit (No. 766100016), back plate support with segments (Cu set No. 23047, MLP set No. 23008), ROCASE 4414 incl. inlay (No. 1300003541 + No. 1300004708)

Model	kg	No.
TB MAXI set 12 - 15 - 18 - 22 mm	3.5	023020X
TB MAXI set 12 - 14 - 16 - 18 - 22 mm	3.5	023021X
TB MAXI set 3/8 - 1/2 - 5/8 - 3/4 - 7/8"	3.3	023022X
TB MAXI set MLP 14 - 16 - 18 - 20 - 25 mm	3.3	023090X
TB MAXI set MLP 14 - 16 - 18 - 20 - 26 mm	3.3	023091X
Basic tool w/o back plate support	1.0	766100016
Back plate support w/o support segment	0.5	R2301500
Support segments MLP R/L 10 - 25 mm (2 pcs.)	0.5	23008
Support segments R/L 12 - 22 mm (2 pcs.)	0.1	23047

Previous bending segments and support segments from earlier models are compatible!

TUBE BENDER MAXI bending segments

Model	Size	max. mm	g	No.
Bending segment	10 mm	1.0	80	23001
Bending segment	12 mm	1.0	80	23002
Bending segment	14 mm	1.0	80	23003
Bending segment	15 mm	1.0	90	23004
Bending segment	16 mm	1.0	100	23005
Bending segment	18 mm	1.0	140	23006
Bending segment	22 mm	1.0	170	23007
Bending segment	3/8"	1.0	70	23010
Bending segment	1/2"	1.0	80	23011
Bending segment	5/8"	1.0	100	23012
Bending segment	3/4"	1.0	120	23013
Bending segment	7/8"	1.0	170	23014

Bending

Manual

TUBE BENDER MAXI MLP

One-handed bending tool for precision bending of multi-layered composite pipes (MLP), Ø 14 - 32 mm



Product profile

APPLICATION AREA

Universal bending tool. Increases safety by reducing the number of joints. Eliminates the costs for bending formers, storage and purchase.

KEY FEATURES

- Ideal in confined spaces
- Quick release and resetting of bending formers
- Bending formers easily changed
- Optimal bending results
- Reduction of pressure-loss in the unit due to the low cross-sectional constriction as compared to prefabricated form pieces

3

Adjustable bending frame

Production of U-bends, counter bends, swan-neck bends and connecting bends possible at all levels

Ratchet arm with bayonet coupling

Bending formers easily changed

Plastic bending formers and support segments with increased conductivity

Optimum bending results

Smooth running feed lever

Ideal for use in confined spaces and for one-handed operation

Release lever

Quick release and resetting of bending formers

Mechanical ratchet feed

Quick operation

Body made of resistant die-cast steel

Sturdy and long-lasting

Fig. TUBE BENDER MAXI MLP

Universal field operation



Sets (No. 23065 / 23095) include: TUBE BENDER MAXI MLP (No. 23076), support brackets (No. 23080), bending segments in carrying case

Model	Description	No.
TUBE BENDER MAXI MLP	14 - 16 - 18 - 20 - 25 - 32 mm	23065
TUBE BENDER MAXI MLP	14 - 16 - 18 - 20 - 26 - 32 mm	23095

ACCESSORIES



Description	g	No.	Description	g	No.
Bending segment 14 x 2,0 mm	80	23003	Bending segment 26 x 2,0 mm	200	23053
Bending segment 16 x 2,0 mm	100	23005	Bending segment 32 x 2,0 mm	380	23051
Bending segment 18 x 2,0 mm	140	23050	Basic tool 32 w/o support brackets	1,280	23076
Bending segment 20 x 2,0 mm	150	23052	Support brackets with support segments R/L 23076	790	23080
Bending segment 25 x 2,0 mm	180	23009	Support segment MLP R/L 14 - 32 mm for 23076 (1 pc.)	200	23083

Pro bender

For Bending of pipes out of copper, stainless steel and carbon steel in the sizes 10 mm and 16 mm and 3/8" - 3/4"

KEY FEATURES

- Bending of pipes out of copper, stainless steel and carbon steel possible
- Long lasting due to forged cast iron body
- Comfortable working due to long levers and rubber handles
- Clamping surface for working with a vice



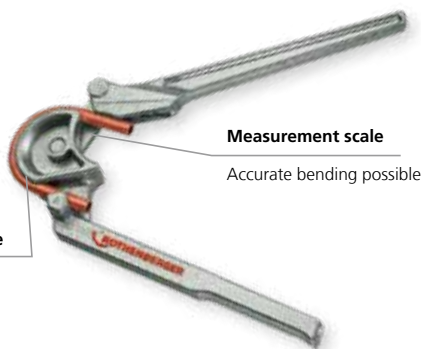
Size	max. mm	R Radius mm	L mm	kg	No.
3/8" / 10 mm	1.0	40	530	2.2	1000001431
1/2"	1.0	47	530	2.1	767050016
5/8" / 16 mm	1.0	76	770	4.0	1000000445
3/4"	1.0	76	770	3.9	767750016

MULTIBEND standard bender 180°

For accurate bending up to 180° of pipes made of soft copper, aluminium and precision steel Ø 10 - 18 mm

KEY FEATURES

- Bending radius display of 0 - 180° for accurate bending
- Clamp mechanism for better pipe hold allows the bending of shorter pipe pieces
- Light construction allows for fatigue-free hand operation



Size	max. mm	R Radius mm	kg	No.
10 mm	1.0	30	0.37	25401
12 mm	1.0	36	0.64	25402
14 mm	1.0	42	0.98	25403
15 mm	1.0	48	1.45	25404
16 mm	1.0	48	1.46	25405
18 mm	1.0	54	2.00	25406

Standard two handed bender 90°

For accurate bending up to 90° for pipes made of semi-hard copper according to DIN EN 1057 Ø 12 x 1.0 - 22 x 1.0 mm

KEY FEATURES

- Universal bender for sanitary and heating installations refrigeration and air-conditioning systems
- Long handles allow for better leverage in the bending of semihard copper pipes
- Bending pliers with sliding carriage for millimetre-exact bending
- Accurate adjustments between the bending radius and handle length reduces effort required



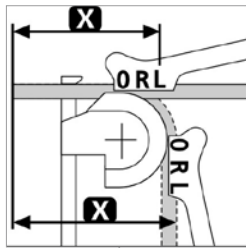
Size	mm	R Radius mm	L mm	kg	No.
12 mm	1.0	43	460	1.4	462212
15 mm	1.0	60	600	2.3	462215
18 mm	1.0	74	860	3.2	462218
22 mm	1.0	87	900	4.3	462222

Bending

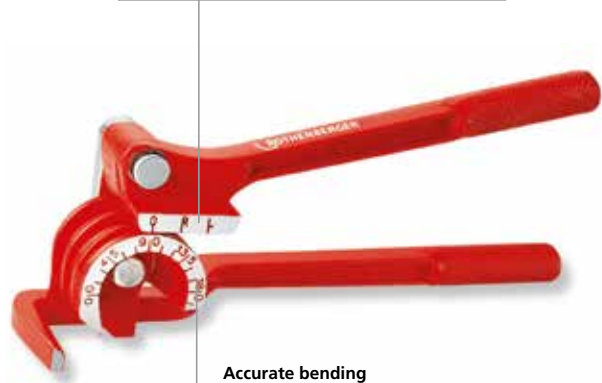
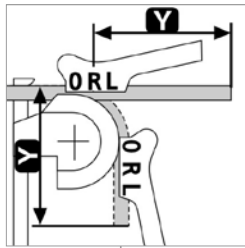
Manual

3

Method L



Method R



Accurate bending

Minimum size chart and bending radius display on measurement scale

MINIBEND

For accurate two handed bending up to 180° of pipes made of soft copper, brass, aluminium and precision steel Ø 6 - 10 mm (1/4 - 3/8")

KEY FEATURES

- Suitable for use in refrigeration and air-conditioning, oil supply, automotive, hydraulic and pneumatic industries

Method L: Determination of the length of L - Left:

O: Reference to bending scale (0-0) and/or start/end of the bending radius
L: Used to determine/indicate the final dimension desired from the left (pipe beginning) up to top edge of the pipe (Measure X)

Method R: Determination of the length of R - Right:

O: Reference to bending scale (0-0) and/or start/end of the bending radius
R: Used to determine/indicate the final dimension desired from the right (pipe beginning) up to top edge of the pipe (Measure Y)

Model	Size	g	No.
MINIBEND	6 - 8 - 10 mm	420	25150
MINIBEND	1/4 - 5/16 - 3/8"	420	25151

Standard bender 180°

For accurate bending up to 180° of pipes made of soft copper, aluminium and precision steel Ø 6 - 18 mm (1/4 - 5/8")

KEY FEATURES

- Bending angle measurement of 0 - 180° for accurate bending
- Clamp mechanism for better pipe hold allows the bending of shorter pipe pieces
- Light construction allows for fatigue-free hand operation

Accurate bending

Minimum size chart and bending radius display on measurement scale



Size	R Radius mm	L mm	g	No.
6 mm	18	305	550	25130
10 mm	30	390	970	25132
12 mm	36	390	980	25133
14 mm	47	450	1,580	25134
15 mm	54	450	1,830	25135
16 mm	58	450	1,830	25136
18 mm	66	480	2,110	25137
1/4"	18	305	560	25140
5/16" / 8 mm	24	305	640	25131
1/2"	30	390	1,680	25142
5/8"	58	450	1,830	25136

ACCESSORIES



Description	No.
Internal / external deburrer	32 1500000236
Bending spray, 150 ml	63 25120

Copper tube bending springs

For free-handed bending of soft copper pipes
Ø 8 - 16 mm (1/4 - 5/8")

KEY FEATURES

- Coiled cone for ideal handling even with longer pipes
- Tough and long lasting with the cadmium-plated spring steel
- Optimal spring form prevents buckling in bending radius area



Size	g	No.
8 mm	70	25181
10 mm	80	25182
12 mm	160	25183
15 mm	220	25185
16 mm	220	25186

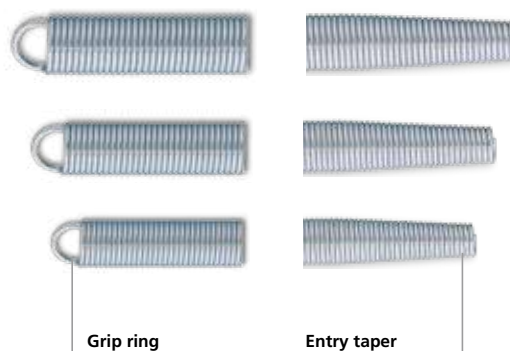
Size	g	No.
5/16"	70	25181
1/2"	130	25190
5/8"	220	25186

MLP internal bending springs

For hand bending of aluminium multi-layer pipes (MLP)
Ø 6 - 20 mm

KEY FEATURES

- Ideal operation even with longer pipes:
Grip ring for retraction out of the pipe
- Entry taper for clean insertion in the pipe
- Sturdy and long lasting: NIROSTA spring steel
- Pipe will not buckle due to optimal spring form



Grip ring

for insertion into and retraction out of the pipe

Entry taper

for clean insertion in the pipe

Model	Bending spring	Pipe	g	No.
MLP-internal-bending spring	6.0 mm	12 mm	90	25441
MLP-internal-bending spring	8.0 mm	14 mm	120	25442
MLP-internal-bending spring	10.0 mm	16 mm	150	25443
MLP-internal-bending spring	13.5 mm	20 mm	220	25445
MLP-internal-bending spring	19.0 mm	25/26 mm	380	25446



Bending spray

For bending copper and steel pipes

KEY FEATURES

- Combination of slide and bending oil
- Because of the special viscosity even copper and steel pipes are able to be bent easily

Model	Contents	No.
Bending spray, 150 ml	150 ml	25120



ACCESSORIES



Description	No.
Internal / external deburrer	32 150000236

Bending

Manual

ROBEND H+W PLUS

For accurate cold bending up to 180°,
 Ø 8 - 22 mm (5/16 - 7/8")



Product profile

APPLICATION AREA

For accurate bending up to 180° on pipes made of:

Copper (soft, semi-hard, hard thin-walled):	Ø 8 - 22 mm	5/16 - 7/8"
Copper (coated, also thin-walled):	Ø 10 - 18 mm	3/8 - 5/8"
Aluminium and brass:	Ø 8 - 22 mm	5/16 - 7/8"
Precision steel (also coated):	Ø 10 - 22 mm	3/8 - 5/8"
Seamless stainless steel:	Ø 8 - 22 mm	5/16 - 7/8"

KEY FEATURES

- Exact bending to the mm on continuous pipe
- Retains shape and remains stable
- Two-handed bending possible with the additional handle up to Ø 18 mm / 5/8"
- Eliminates the costs of purchase and storage of bending formers
- Easy bending through clamping on a vice
- Exact bending with the minimum size chart and bending radius display

3

ROLUB-Anti-Block-System

Less effort due to lower friction and optimum distribution of the bending spray

ROLUB-Anti-Block-System!

Optimum combination of ROLUB guide shoe and the bending former

Perfect bending results without friction marks

Minimum size chart and bending radius display

Accurate bending

Bending formers with base plate

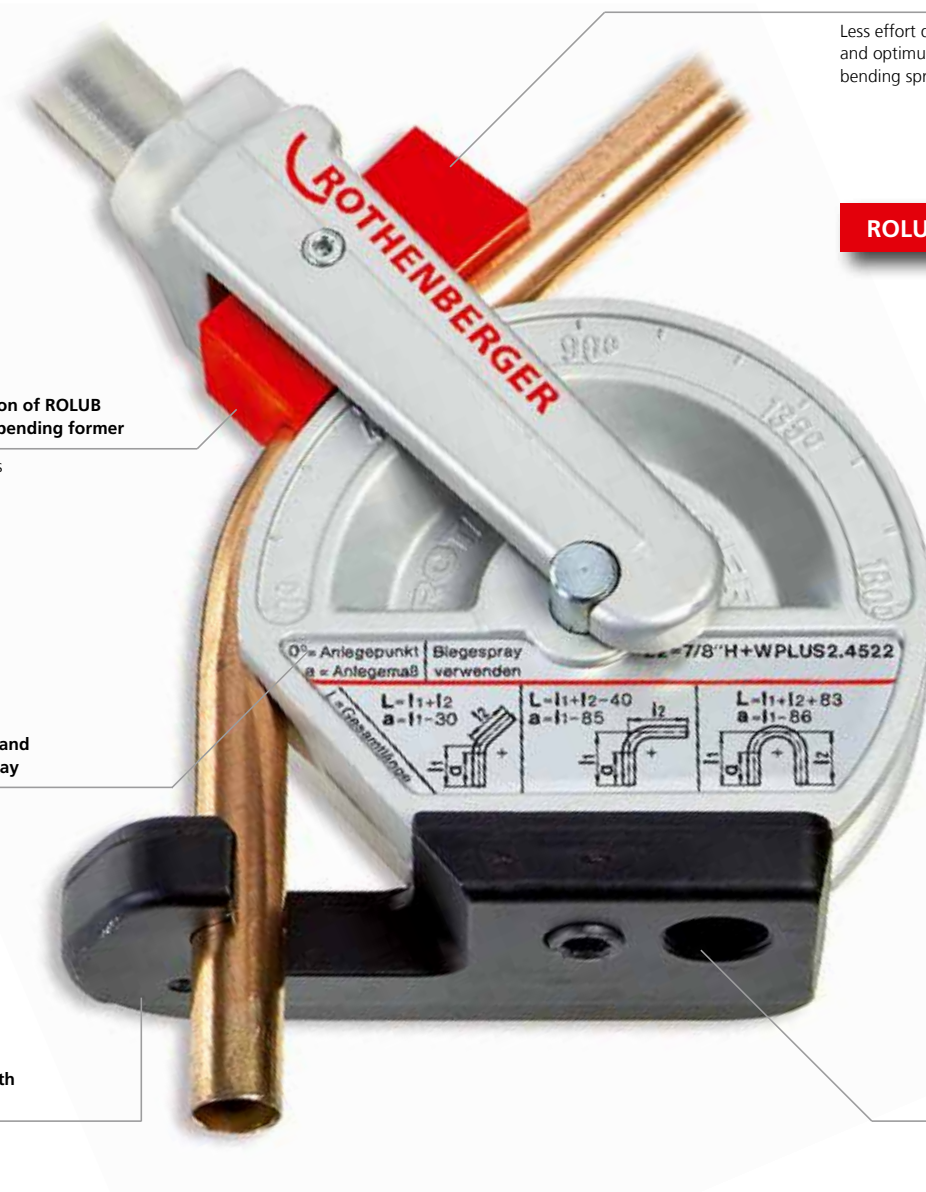
Easy bending through clamping on a vice

Made from high-quality forged aluminium

Retains shape and remains stable

Thread for the attachment of the additional lever (accessories)

Free-hand bending possible



ROBEND H+W PLUS bender

Universal hand bender complete with bending former, fork with ROLUB guide shoe and handle. Universal application in sanitary and heating installations, refrigeration and air-conditioning systems and industrial systems.



ROBEND H+W PLUS bender

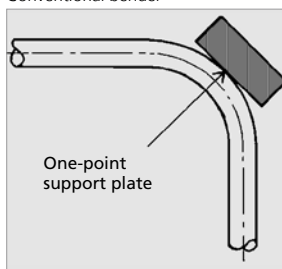
Size	max mm	R Radius mm	g	No.
8 mm	1	22	660	24508
10 mm	1	32	1,180	24510
12 mm	1	38	1,110	24512
14 mm	1	45	1,370	24514
15 mm	1	45	1,370	24515
16 mm	1	64	2,620	24516
18 mm	1	64	2,620	24518
22 mm	1	81	3,800	24522
5/16"	1	22	660	24508
1/2"	1	38	1,110	24552
5/8"	1	64	2,620	24516
3/4"	1	81	3,850	24519
7/8"	1	81	3,800	24522

ACCESSORIES (additional lever for two-handed bending)*

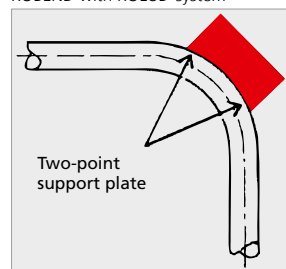
Lever (short) for bending formers Ø 8 mm / 3/8"	25075
Lever for bending formers Ø 10 - 15 mm	25076
Lever for bending formers bigger than Ø 15 mm	25078
Bending spray, 150 ml	25120
ROCASE 6414	1300003542
Plastic inlay f. ROCASE 6414	1300004002

*Possible from 10 mm

Conventional bender



ROBEND with ROLUB-system



Accurate bending



ROBEND H+W PLUS bending sets

Sets include: ROCASE 6414 for a maximum of 6 bending formers, 2 levers for vice bending and bending spray (No. 25120). Bender corresponds to the respective pipe dimensions.

ROBEND H+W PLUS bending sets

Model	Description	mm	kg	No.
ROBEND H+W PLUS	12 - 15 - 18 - 22 mm	1.0	16.5	24500
ROBEND H+W PLUS	10 - 12 - 14 - 16 mm	1.0	16.3	24501
ROBEND H+W PLUS	12 - 14 - 16 - 18 mm	1.0	13.6	24502
ROBEND H+W PLUS	15 - 18 - 22 mm	1.0	14.9	24505
ROBEND H+W PLUS	1/2 - 5/8 - 3/4"	1.0	13.6	24503
ROBEND H+W PLUS	1/2 - 5/8 - 7/8"	1.0	13.7	24504

ROLUB Anti-Block special guide shoe

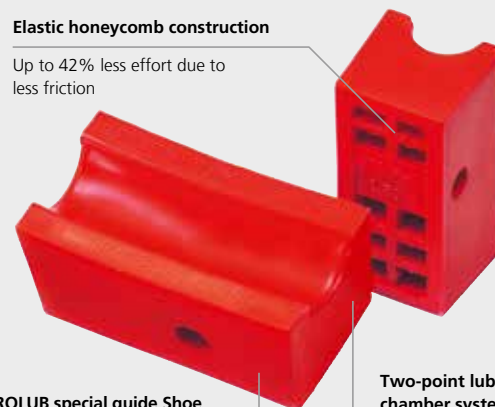
Size	g	No.
8 mm	20	25308
10 mm	20	25310
12 mm	30	25312
14 mm	30	25314
15 mm	30	25315
16 mm	50	25316
18 mm	50	25318
22 mm	90	25322
5/16"	20	25308
1/2"	30	25313
5/8"	50	25316
3/4"	90	25319
7/8"	90	25322

ROLUB Anti-Block special guide shoe

Especially adapted to the ROBEND H+W PLUS bender the ROLUB guide shoe with two-point lubricating chamber system

Elastic honeycomb construction

Up to 42% less effort due to less friction



ROLUB special guide Shoe made of high-quality polyamide

Perfect bending results without friction marks

Two-point lubricating chamber system

Ensures optimum distribution of lubrication

Bending

Manual hydraulic

ROBULL type E

For precise, manual hydraulic cold bending up to 90°



Product profile

APPLICATION AREA

Broadly applicable, universal portable hydraulic bending system for plumbing, sanitary and heating installation on construction sites, for apparatus and boiler construction and for industrial use. Also suitable for aligning tubes.

ROBULL type E:

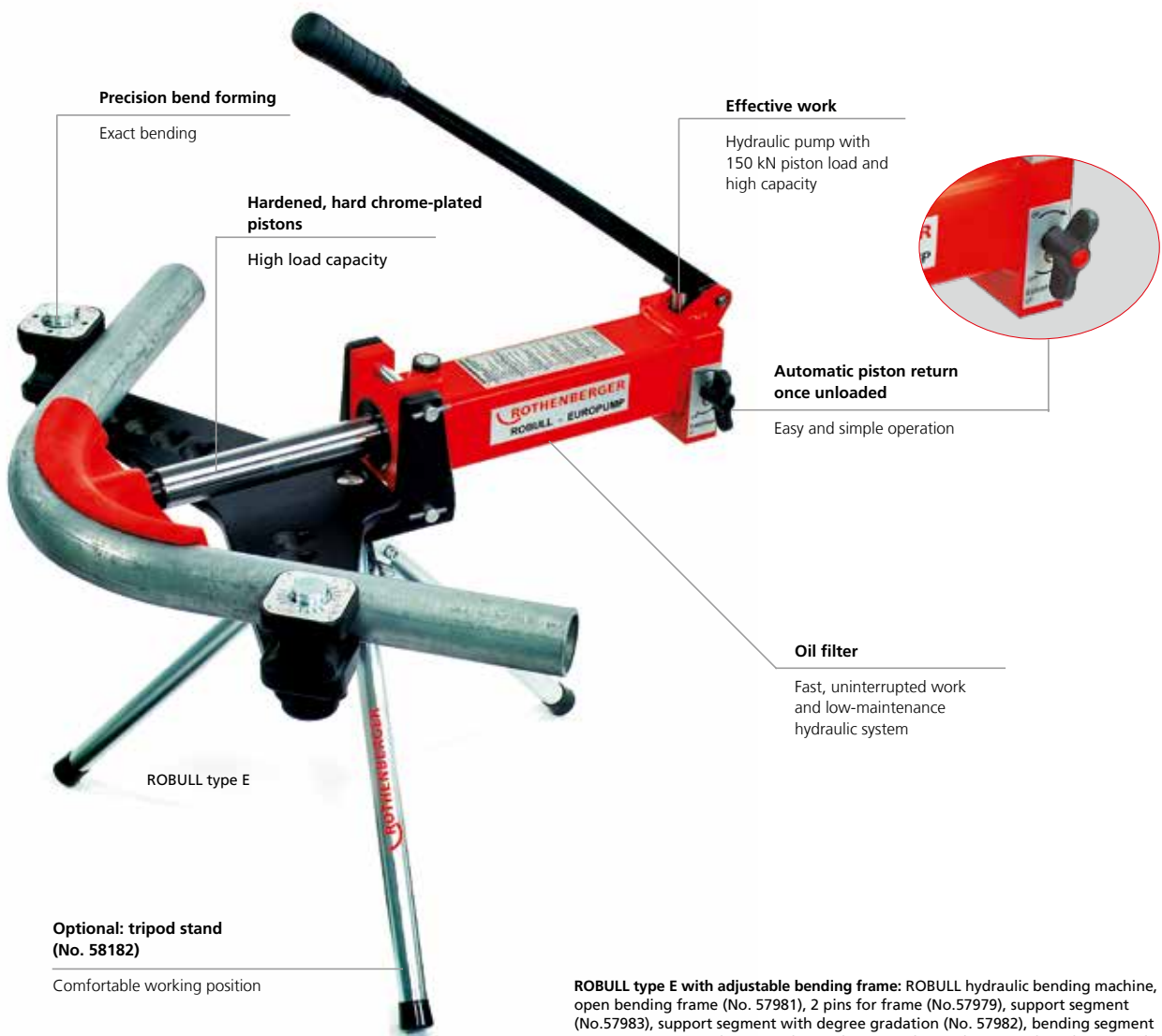
For accurate bending up to 90° on pipes made of:

Carbon steel suitable for welding and thread-cutting: \varnothing 3/8 - 2"

KEY FEATURES

- Precise bending with the angle scale on the support brackets
- Reduces welded joints
- No pre-warming of pipe is required
- No bending forms needed
- Works quicker with the 150 kN piston strength
- Easy and simple operation
- Closed, low-maintenance hydraulic system with a mono-block design and with quick, automatic piston retraction
- Comfortable working position with the tripod stand (opt.)
- With foldable and adjustable bending frame

3



Optional: tripod stand (No. 58182)

Comfortable working position

ROBULL type E with adjustable bending frame: ROBULL hydraulic bending machine, open bending frame (No. 57981), 2 pins for frame (No.57979), support segment (No.57983), support segment with degree gradation (No. 57982), bending segment standard 90° in 3/8" (No. 57985), 1/2" (No. 57986), 3/4" (No. 57987), 1" (No. 57988), 1.1/4" (No. 57989), 1.1/2" (No. 57990), 2" (No. 57991), hydraulic oil 1 l (No. 58185), steel carrying case (No. 58206)

ROBULL type E with foldable bending frame: same scope of delivery as the ROBULL type E with adjustable bending frame but with foldable bending frame (No. 58002)

Model	Description	kg	No.
ROBULL type E	without accessories	16.8	057950X
ROBULL type E	with adjustable bending frame and accessories (see above)	59.8	057966X
ROBULL type E	with foldable bending frame and accessories (see above)	72.6	057961X

ROBULL type E



ROBULL type E with foldable bending frame



Fig. similar

ROBULL type E bending segments

Small bending radius (red)

inch	mm	Wall thickness min. mm	R mm	kg	No.
3/8"	17.2	2.35	45	0.7	57985
1/2"	21.3	2.65	49	0.7	57986
3/4"	26.9	2.65	65	0.8	57987
1"	33.7	3.25	89	1.3	57988
1.1/4"	42.4	3.25	115	1.6	57989
1.1/2"	48.3	3.25	137	2.4	57990
2"	60.3	3.65	200	3.2	57991

ROBULL type E bending segments

Large bending radius (black)

inch	mm	Wall thickness min. mm	R mm	kg	No.
3/8"	17.2	2.35	56	0.8	58010
1/2"	21.3	2.35	85	0.9	58011
3/4"	26.9	2.65	115	1.2	58012
1"	33.7	2.65	145	2.1	58013
1.1/4"	42.4	3.25	180	3.5	58014
1.1/2"	48.3	3.25	214	4.3	58015
2"	60.3	3.65	245	5.6	58016

ACCESSORIES



Model	kg	No.
Bending frame, adjustable	15.2	57981
Support segments f. ROBULL E / ME with degree gradation (1 piece)	2.6	775004000
Support segments f. ROBULL E / ME without degree gradation (1 piece)	2.6	57983

Model	kg	No.
Sup. seg. w/ degree gradation, foldable, E/ME 12.5		775504100
Locking pin	0.3	57979
Hydraulic oil, 1 litre	1.0	58185
Tripod stand	3.0	58182
Steel case	10.0	996277400

Bending

Electro-hydraulic

ROBULL type ME

For precise, power hydraulic cold bending up to 90°



Product profile

APPLICATION AREA

Various uses, mobile hydraulic bending machine for use on the building site in gas, sanitary and heating installations.

ROBULL type ME:

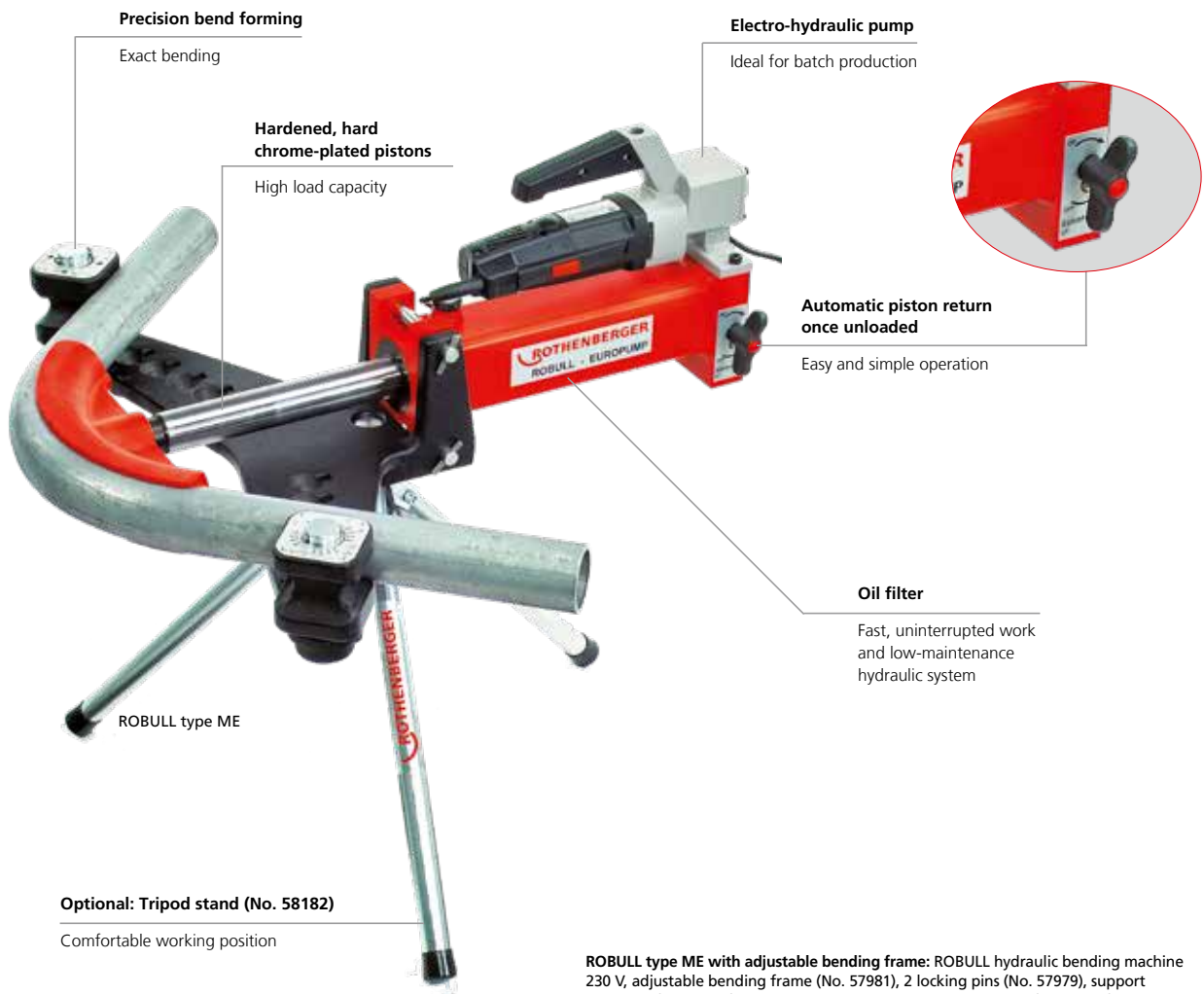
For accurate bending up to 90° on pipes made of:

Carbon steel suitable for welding and thread-cutting: Ø 3/8 - 2"

KEY FEATURES

- Precise bending with the angle scale on the support segments
- Reduces welding joints
- Pre-warming of the pipe no longer necessary
- No bending forms are necessary
- Effective use with the 150 kN piston strength
- Easy and simple operation
- Closed, low-maintenance hydraulic system with a mono-block design and with quick, automatic piston retraction
- Comfortable working position with the tripod stand (optional)
- With foldable and adjustable bending frame

3



ROBULL type ME with adjustable bending frame: ROBULL hydraulic bending machine 230 V, adjustable bending frame (No. 57981), 2 locking pins (No. 57979), support segments (No. 57983), support segments with degree gradation (No. 57982), bending segments standard 90° in 3/8" (No. 57985), 1/2" (No. 57986), 3/4" (No. 57987), 1" (No. 57988), 1.1/4" (No. 57989), 1.1/2" (No. 57990), 2" (No. 57991), hydraulic oil 1 l (No. 58185), steel carrying case (No. 58206)

ROBULL type ME with foldable bending frame: same scope of delivery as ROBULL type ME with adjustable bending frame but with foldable bending frame (No. 58002)

Model	Description	kg	No.
ROBULL type ME	without accessories	17.8	057969X
ROBULL type ME	with adjustable bending frame and accessories (see above)	59.8	057973X
ROBULL type ME	with foldable bending frame and accessories (see above)	72.6	057972X

ROBULL type ME



ROBULL type ME with foldable bending frame



Fig. similar

ROBULL type ME bending segments

Small bending radius (red)

inch	mm	Wall thickness min. mm	R mm	kg	No.
3/8"	17.2	2.35	45	0.7	57985
1/2"	21.3	2.65	49	0.7	57986
3/4"	26.9	2.65	65	0.8	57987
1"	33.7	3.25	89	1.3	57988
1.1/4"	42.4	3.25	115	1.6	57989
1.1/2"	48.3	3.25	137	2.4	57990
2"	60.3	3.65	200	3.2	57991

ROBULL type ME bending segments

Large bending radius (black)

inch	mm	Wall thickness min. mm	R mm	kg	No.
3/8"	17.2	2.35	56	0.8	58010
1/2"	21.3	2.35	85	0.9	58011
3/4"	26.9	2.65	115	1.2	58012
1"	33.7	2.65	145	2.1	58013
1.1/4"	42.4	3.25	180	3.5	58014
1.1/2"	48.3	3.25	214	4.3	58015
2"	60.3	3.65	245	5.6	58016

ACCESSORIES



Model	kg	No.
Bending frame, adjustable	15.2	57981
Support segments f. ROBULL E / ME with degree gradation (1 piece)	2.6	775004000
Support segments f. ROBULL E / ME without degree gradation (1 piece)	2.6	57983

Model	kg	No.
Sup. seg. w/ degree gradation, foldable, E/ME 12.5		775504100
Locking pin	0.3	57979
Hydraulic oil, 1 litre	1.0	58185
Tripod stand	3.0	58182
Steel case	10.0	996277400

Bending

Electro

ROBEND 4000

Portable, sturdy and powerful. The successor of the proven ROBEND 3000, now with a higher bending capacity. Cold bending up to 180°, Ø 12 - 35 mm (1/2 - 1.3/8").



Product profile

APPLICATION AREA

Universal application in sanitary and heating installations, in pipeline construction, refrigeration and air-conditioning systems as well as industrial systems and batch production. Fewer joints means less potential for leaks. Safety implies less likelihood of injury.

Suitable for pipes made of:

Copper (hard, semi-hard and soft DIN EN 1057, 12735-1, 13348): Ø 12 - 35 mm, (1/2-1.3/8")

Copper and precision steel (coated): Ø 12 - 28 mm, (1/2-1.1/8")

Precision steel (soft DIN 2391 / 2393 / 2394): Ø 12 - 28 mm, (1/2-1.1/8")

Threaded steel (DIN 2440 / 2441): Ø 1/2", 3/4"

Seamless stainless steel (GW 541): Ø 12 - 28 mm, (1/2-1.1/8")

KEY FEATURES

- Quick return on investment through the savings from joints, soldering material and energy
- Universal application: U-bends, counter-bends, swan-neck bends and connecting bends possible at all levels
- Retains shape and remains stable: bending formers made of high-quality forged aluminium
- Top-quality, precise and simple to use
- Bending without deformation or ripples due to less friction
- Motor rating: 1,010 W

3



Forged aluminium former with bending radius scale

Easy to use

Pre-adjustment of the bending angle without tools

Fast and precise bending

ROLUB special guide shoe

Bending without deformation or ripples due to less friction

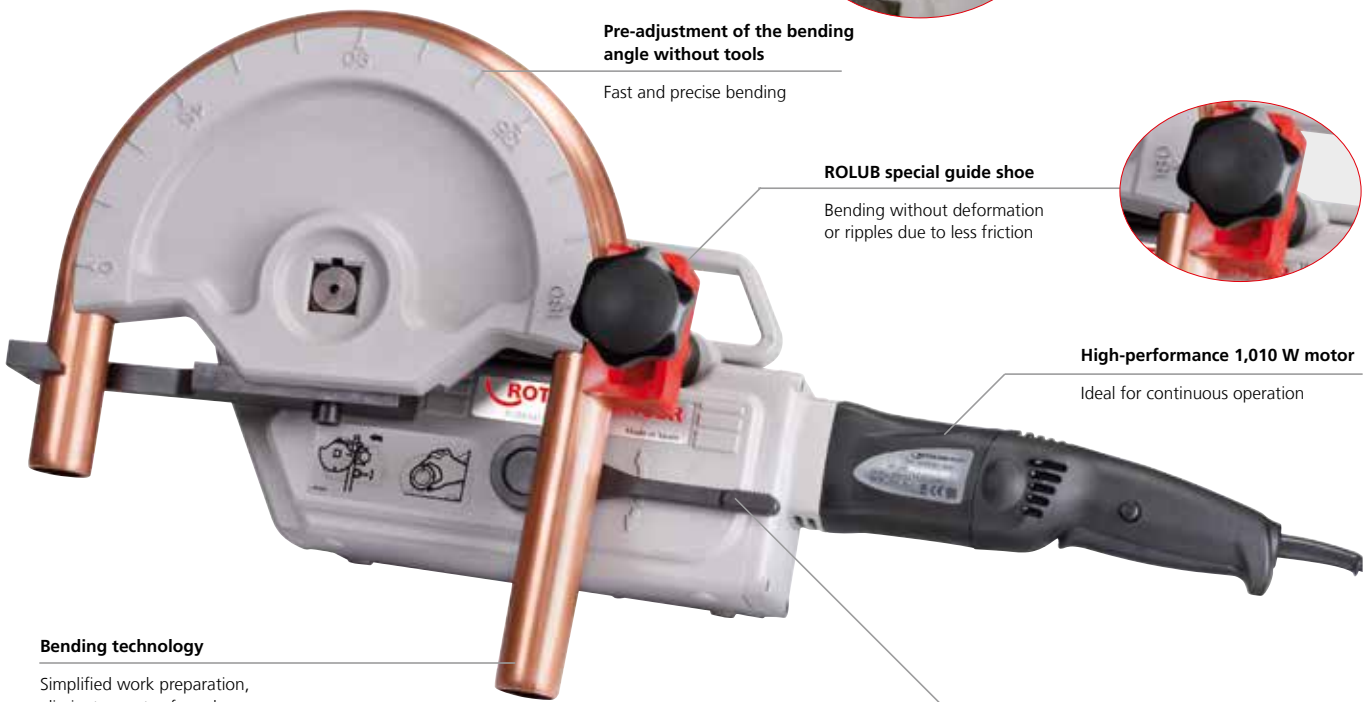


High-performance 1,010 W motor

Ideal for continuous operation

Automatic switch-off when preset bending angle is obtained

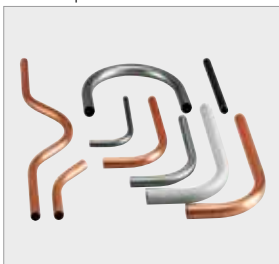
Fast batch production possible



Bending technology

Simplified work preparation, eliminates costs of purchase and storage of fittings

Bending of pipes made of various materials possible



Seven-fold drive



Comfortable carry handle



ROBEND 4000 with tripod stand



ROBEND 4000 E

Electrical bending machine for bending pipes with \varnothing 12 - 35 mm (1/2 - 1.3/8")



Product profile

APPLICATION AREA

Universal application in sanitary and heating installations, in pipeline construction, refrigeration and air-conditioning systems as well as industrial systems and batch production. Fewer joints means less potential for leaks. Safety implies less likelihood of injury.

Suitable for pipes made of:

Copper (hard, semi-hard and soft DIN EN 1057, 12735-1, 13348): \varnothing 12 - 35 mm, (1/2-1.3/8")

Copper and precision steel (coated): \varnothing 12 - 28 mm, (1/2-1.1/8")

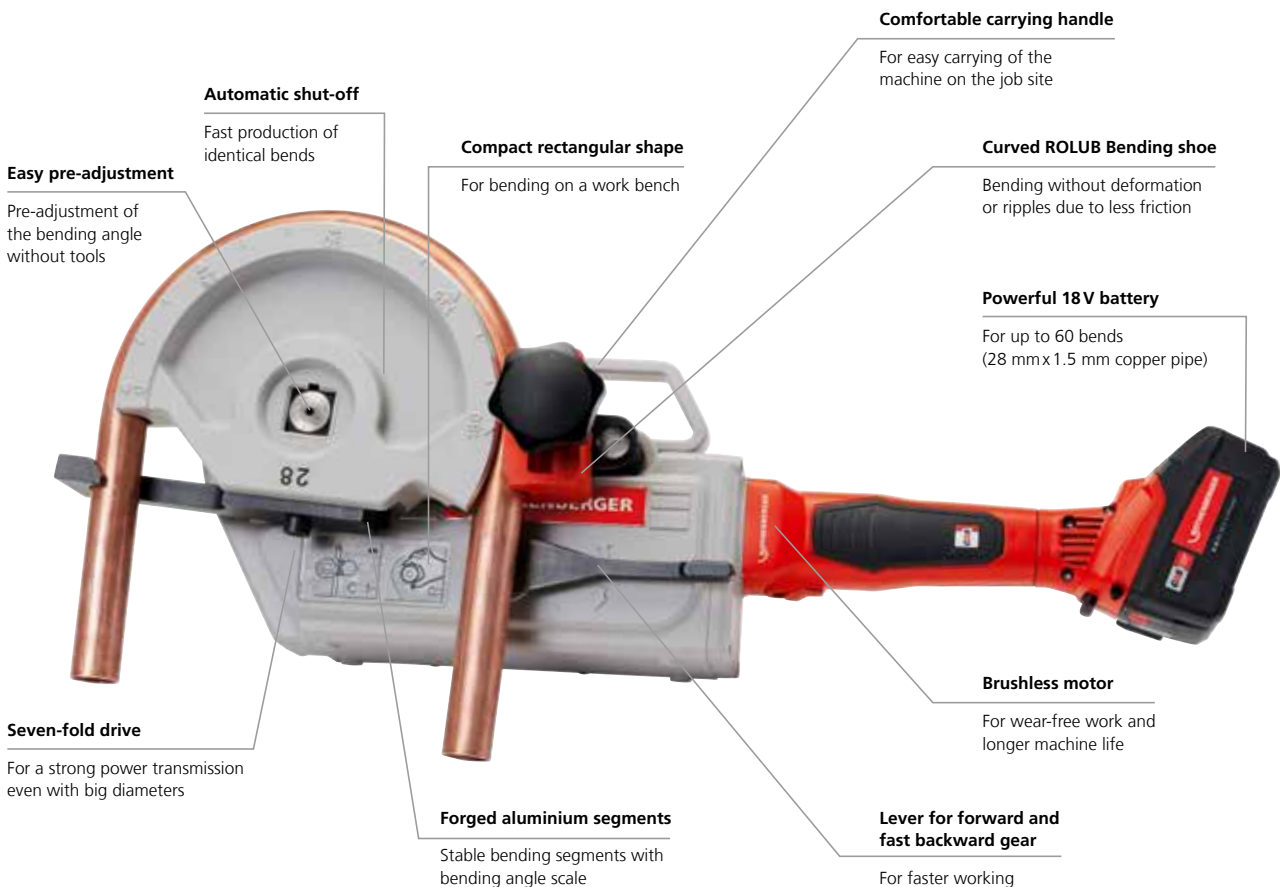
Precision steel (soft DIN 2391 / 2393 / 2394): \varnothing 12 - 28 mm, (1/2-1.1/8")

Threaded steel (DIN 2440 / 2441): \varnothing 1/2", 3/4"

Seamless stainless steel (GW 541): \varnothing 12 - 28 mm, (1/2-1.1/8")

KEY FEATURES

- Quick return on investment through the savings from joints, soldering material and energy
- Universal application: U-bends, counter-bends, swan-neck bends and connecting bends possible at all levels
- Retains shape and remains stable: bending formers made of high-quality forged aluminium
- Top-quality, precise and simple to use
- Bending without deformation or ripples due to less friction



Forged aluminium segments with bending angle scale



Working with a Tripod



Comfortable carry handle



Compact, rectangular shape



¹⁾ Complete terms and conditions at rothenberger.com/roservice
RO SERVICE+ only valid in participating countries

Bending

Electro

ROBEND 4000/4000 E sets

Sets include: basic 230 V unit (No. 1000001559), bending formers and guide shoes for respective pipe diameters, guide shoe axle (No. 25743), adaptor for tripod stand (No. 25748) in basic unit (tripod stand optional), carrying case



ROLUB-Anti-Block-System!



ROLUB special guide shoe made of high-quality polyamide

Perfect bending results without friction marks

Two-point lubricating chamber system

Ensures optimum distribution of lubrication



Fig. similar



Model	Description	Pipe type	kg	No.
ROBEND 4000 set	15 - 18 - 22 mm	Cu, Fe et al.	24.12	1000001554
ROBEND 4000 set	15 - 18 - 22 - 28 mm	Cu, Fe et al.	24.12	1000001550
ROBEND 4000 set	12 - 14 - 16 - 18 - 22 mm	Cu, Fe et al.	21.90	1000001551
ROBEND 4000 set	15 - 22 - 28 mm	Cu, Fe et al.	21.10	1000001545
ROBEND 4000 set	12 - 14 - 16 - 18 - 22 - 28 mm	Cu, Fe et al.	24.10	1000001552
ROBEND 4000 set	12 - 15 - 18 - 22 - 28 mm	Cu, Fe et al.	23.50	1000001549
ROBEND 4000 set	15 - 18 - 22 - 28 - 32 - 35 mm	Cu, Fe et al.	32.00	1000001567
ROBEND 4000 set	1/2 - 5/8 - 3/4 - 7/8"	Cu, Fe et al.	19.60	1000001553
ROBEND 4000 set	1/2 - 5/8 - 3/4 - 7/8 - 1.1/8 - 1.3/8"	Cu, Fe et al.	29.00	1000001565
ROBEND 4000 set	7/8 - 1.1/8 - 1.3/8"	Cu, Fe et al.	22.00	1000001566
ROBEND 4000 set	15 - 18 - 22 - 28 - 35 mm	Cu, Fe et al.	29.00	1000001738
ROBEND 4000 basic unit	in carrying case without bending segments	Cu, Fe et al.	14.50	1000001559
ROBEND 4000 E base machine, without battery and charger		Cu, Fe et al.	17.45	1000003391
ROBEND 4000 E set with battery, 4.0Ah 18V and battery charger	15 - 18 - 22 - 28 mm	Cu, Fe et al.	29.15	1000003392
ROBEND 4000 E set with battery, 4.0Ah 18V and battery charger	12 - 14 - 16 - 18 - 22 - 28 mm	Cu, Fe et al.	30.15	1000003393
ROBEND 4000 E set with battery, 4.0Ah 18V and battery charger	1/2 - 5/8 - 3/4 - 7/8 - 1.1/8"	Cu, Fe et al.	29.45	1000003394

ACCESSORIES



Model	No.	Model	No.
Bending spray, 150 ml	25120	RO BP18/4, 4.0Ah 18V Li-Power Akku	1000001653
Guide shoe axle	25743	RO BC14/36 Ladegerät, 230 V, EU	1000001654
ROBEND carrying case, for 5 segments up to Ø 30 mm	995830200	Pipe cutter	14 - 27
Tripod stand, foldable	25748	Internal / external deburrer	32
ROBEND carrying case, for 32 mm (1.1/4") and 35 mm (1.3/8")	1000001564		

ROBEND 3000/4000/4000 E Bending formers

For bending pipes Ø 12 - 35 mm (1/2 - 1.3/8")



Fig. ROBEND 3000/4000/4000 E bending set with ROLUB special guide shoe

For steel pipe DIN 2440 and DIN 2441 (except 3/4")

Size	Wall thickness mm	Bending radius mm	kg	No.
1/2"	3.25	88	1.42	25684
3/4"	3.25	112	2.90	25685

For copper pipe DIN EN 1057, 12735-1, 13348, aluminium pipe, precision steel pipe DIN 2391/93/94, stainless steel pipe and others

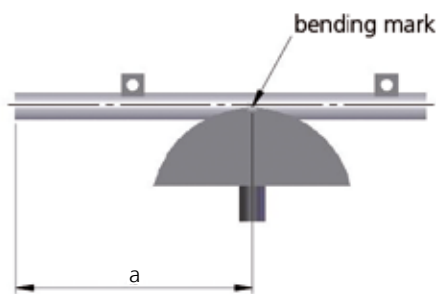
Size	Wall thickness mm	Bending radius mm	kg	No.
12 mm	1.0	42	0.48	25612
14 mm	1.0	49	0.48	25614
15 mm	1.0	52	0.53	25615
16 mm	1.0	56	0.60	25616
18 mm	1.0	72	1.17	25618
20 mm	1.0	80	1.42	25620
22 mm	1.2	88	1.42	25622
28 mm	2.0	112	2.90	25628
32 mm*	2.0	128	3.40	1000001561
35 mm*	2.0	140	3.60	1000001563

For imperial copper pipe DIN EN 1057, 12735-1, 13348 aluminium pipe, precision steel pipe DIN 2391/93/94, stainless steel pipe and others

Size	Wall thickness mm	Bending radius mm	kg	No.
1/2"	1.2	45	0.53	25652
5/8"	1.2	56	0.60	762955300
3/4"	1.2	80	1.42	25619
7/8"	1.2	88	1.42	762955700
1"	1.5	112	2.90	25625
1.1/8"	1.6	112	2.90	25626
1.1/4"*	2.0	128	3.40	1000001561
1.3/8"*	2.0	140	3.60	1000001563

*Bending former sets (No. 1000001561 / No. 1000001563) are only compatible with ROBEND 4000/ROBEND 4000 E. Only matching with optional plastic carrying case (No. 1000001564).

Push bending



Symbols

- L_1, L_2 = Leg length
- a = Lay out length
- L = Total length of the pipe piece
- L_W = Distance / pipe end - wall
- A_W = Distance / pipe middle - wall
- L_M = Minimum length*
- L_R = Reserve length*

45°- arc



$$L = L_1 + L_2$$

$$a = L_1 - L_R$$

90°- arc



$$L = L_1 + L_2 - L_M$$

$$a = L_1 - L_R$$

* All sizes listed are standards and are dependant on the material and the wall thickness. Bending specific sizes based on the bending radius - tabular value

Bending

Bending tables

Calculation examples TUBE BENDER MAXI

Specifications:

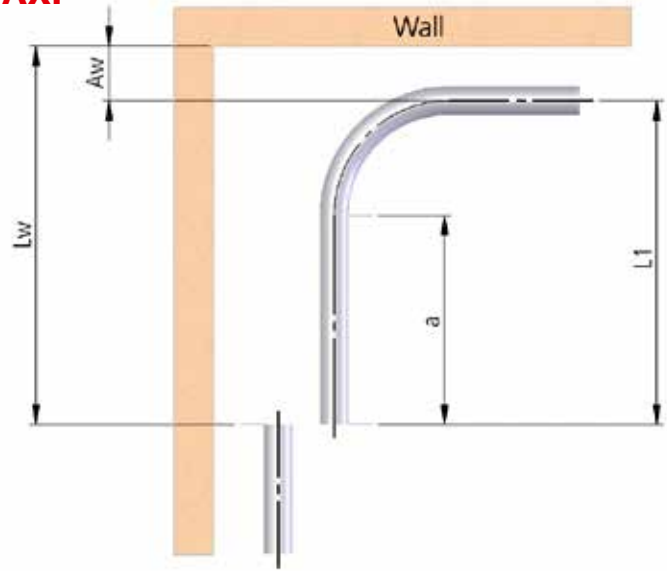
Installation in corner areas
 $L_W = 1,200$ mm
 $A_W = 30$ mm
 Pipe- \varnothing 12 mm, 90°-arc

Sought after:

Leg length L_1
 Applied size a

Solution:

Summary from the TUBE BENDER MAXI bending table



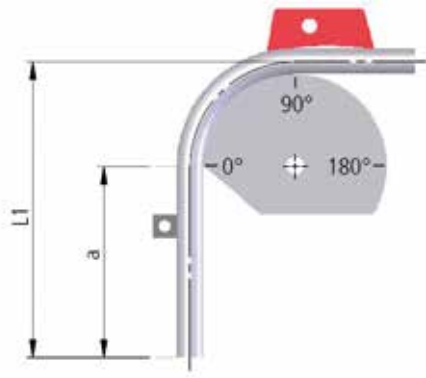
Leg length $L_1 = L_W - A_W = 1,200 - 30 = 1,170$ mm
 Applied size $a = L_1 - L_R = 1,170 - 7.5 = 1,162.5$ mm; L_R ... Tabular value

TUBE BENDER		at 45°		at 90°		at 180°	
for \varnothing mm / inch	Bending radius R (mm)	Reserve length L_R mm	Minimum length L_M mm	Reserve length L_R mm	Minimum length L_M mm	Reserve length L_R mm	Minimum length L_M mm
4.75/5	20.0	4.5	1.0	4.5	10.0	-	-
6	23.5	5.0	1.2	5.0	11.5	-	-
8	28.0	7.0	1.4	7.0	14.0	-	-
9	30.0	7.0	1.5	7.0	15.0	-	-
10	34.0	7.5	1.8	7.5	17.5	-	-
12	37.5	8.5	1.9	8.5	19.0	-	-
3/16"	20.0	4.5	1.0	4.5	10.0	-	-
1/4"	23.5	5.0	1.2	5.0	11.5	-	-
5/16"	28.0	7.0	1.4	7.0	14.0	-	-
3/8"	34.0	7.5	1.8	7.5	17.5	-	-
1/2"	37.5	8.5	1.9	8.5	19.0	-	-

TUBE BENDER MAXI		at 45°		at 90°		at 180°
for \varnothing mm / inch	Bending radius R (mm)	Reserve length L_R mm	Minimum length L_M mm	Reserve length L_R mm	Minimum length L_M mm	Reserve length L_R mm
12	35.0	0.8	10.0	7.5	35.0	-
14	42.5	0.9	12.5	9.0	42.5	-
15	48.5	1.1	14.0	10.5	48.5	-
16	49.0	1.1	14.5	10.5	49.0	-
18	74.0	1.7	22.0	16.0	74.0	-
22	87.0	1.9	25.5	18.5	87.0	-
3/8"	35.0	0.8	10.0	7.5	35.0	-
1/2"	35.0	0.8	10.0	7.5	35.0	-
5/8"	49.0	1.1	14.5	10.5	49.0	-
3/4"	74.0	1.7	22.0	16.0	74.0	-
7/8"	87.0	1.9	25.5	18.5	87.0	-

TUBE BENDER MAXI CT		at 45°		at 90°		at 180°
Tube \varnothing / Ws mm	Bending radius R (mm)	Reserve length L_R mm	Minimum length L_M mm	Reserve length L_R mm	Minimum length L_M mm	Reserve length L_R mm
10 x 0.6	42.5	0.8	12.5	9.0	42.5	-
12 x 0.6	49.0	1.1	14.5	10.5	49.0	-
15 x 0.7	74.0	1.7	22.0	16.0	74.0	-
18 x 0.7	87.0	1.9	25.5	18.5	87.0	-

Pull bending



Symbols

- L_1, L_2 = Leg length
- a = Lay out length
- L = Total length of the pipe piece
- L_W = Distance / pipe end - wall
- A_W = Distance / pipe middle - wall
- L_M = Minimum length*
- L_R = Reserve length*

3

45°- arc

90°- arc

180°- arc



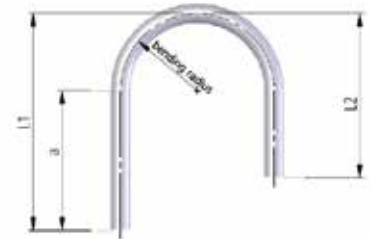
$$L = L_1 + L_2$$

$$a = L_1 - L^R$$



$$L = L_1 + L_2 - L_M$$

$$a = L_1 - L_R$$



$$L = L_1 + L_2 + L_M$$

$$a = L_1 - L_R$$

Calculation examples ROBEND 3000/ROBEND 4000/ ROBEND 4000 E

Specifications:

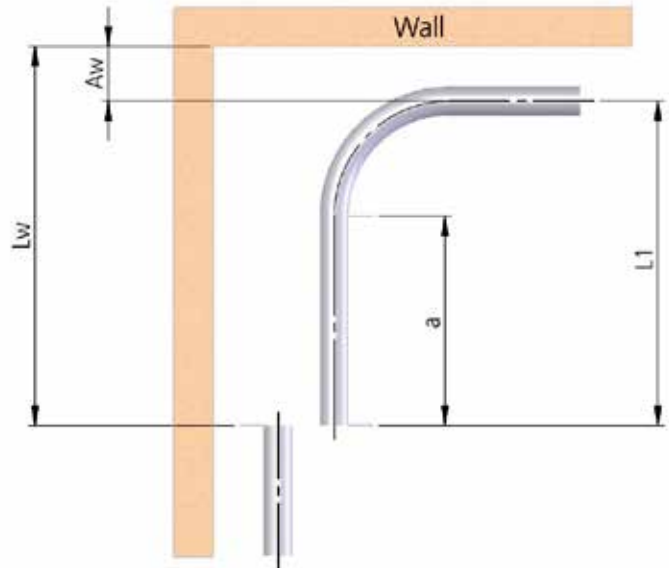
- Installation in corner areas
- $L_W = 1,200$ mm
- $A_W = 30$ mm
- Pipe-Ø 12 mm, 90°-arc

Sought after:

- Leg length L_1
- Applied size a

Solution:

Summary from the ROBEND 3000/4000/4000 E bending table



Leg length $L_1 = L_W - A_W = 1,200 - 30 = 1,170$ mm

Applied size $a = L_1 - L_R = 1,170 - 42 = 1,128$ mm; L_R ... Tabular value

* All sizes listed are standards and are dependant on the material and the wall thickness. Bending specific sizes based on the bending radius - tabular value

Bending

Bending tables

3

ROBEND H+W Plus		at 45°		at 90°		at 180°	
Ø / Ws mm / Inch	Bending radius R (mm)	Reserve length L _R mm	Minimum length L _M mm	Reserve length L _R mm	Minimum length L _M mm	Reserve length L _R mm	Minimum length L _M mm
8	22	9	-	22	9.5	22	47
10	32	12	-	32	15.0	32	34
12	38	15	-	40	20.0	38	39
14	45	17	-	44	22.0	44	51
15	45	17	-	44	22.0	44	51
16	64	25	-	67	30.0	68	65
18	64	25	-	67	30.0	68	65
20	81	30	-	85	40.0	86	83
22	81	30	-	85	40.0	86	83
5/16"	22	9	-	22	9.5	22	47
3/8"	32	12	-	32	20.0	32	34
1/2"	38	15	-	40	22.0	38	39
5/8"	64	25	-	67	30.0	68	65
3/4"	81	30	-	85	40.0	86	83
7/8"	81	30	-	85	40.0	86	83

MINIBEND		at 45°		at 90°		at 180°	
Ø / Ws mm / Inch	Bending radius R (mm)	Reserve length L _R mm	Minimum length L _M mm	Reserve length L _R mm	Minimum length L _M mm	Reserve length L _R mm	Minimum length L _M mm
6	25.0	10.4	1.0	22.0	10.0	22.0	26.0
8	24.0	9.9	1.0	32.0	15.0	32.0	34.0
10	23.0	9.5	1.0	32.0	15.0	32.0	34.0
1/4"	25.0	10.4	1.0	22.0	10.0	22.0	26.0
5/16"	24.0	9.9	1.0	32.0	15.0	32.0	34.0
3/8"	23.0	9.5	1.0	32.0	15.0	32.0	34.0

Standard bender 180°		at 45°		at 90°		at 180°	
for Ø mm / Inch	Bending radius R (mm)	Reserve length L _R mm	Minimum length L _M mm	Reserve length L _R mm	Minimum length L _M mm	Reserve length L _R mm	Minimum length L _M mm
6	18.0	7.0	0.8	18.5	8.0	18.5	20.0
10	30.0	11.5	1.3	30.5	14.5	30.5	34.0
12	36.0	14.0	1.5	36.5	15.0	36.5	37.5
14	47.5	18.5	2.0	48.5	20.5	48.5	52.5
15	54.0	21.0	2.3	56.0	24.5	56.0	58.0
16	58.0	22.5	2.5	64.0	28.5	64.0	67.0
18	66.0	25.5	2.8	68.0	31.0	68.0	72.0
1/4"	18.0	7.0	0.8	18.5	8.0	18.5	20.0
5/16"	24.0	9.5	1.0	24.0	12.0	24.0	27.0
1/2"	42.0	16.5	1.8	49.5	22.5	49.5	53.0
5/8"	58.0	22.5	2.5	64.0	28.5	64.0	67.0

Bending

Bending tables

MULTIBEND		at 45°		at 90°		at 180°	
for Ø mm	Bending radius R (mm)	Reserve length L _R mm	Minimum length L _M mm	Reserve length L _R mm	Minimum length L _M mm	Reserve length L _R mm	Minimum length L _M mm
8	24.0	9.5	1.0	24.0	10.0	24.0	26.0
10	30.0	12.0	1.3	30.5	14.5	30.5	32.5
12	36.0	14.0	1.5	36.5	15.5	36.5	37.5
14	42.0	16.5	1.8	42.0	19.5	42.5	44.0
15	48.0	19.0	2.0	48.0	22.0	48.0	53.0
16	48.0	19.0	2.0	48.0	22.0	48.0	53.0
18	54.0	21.0	2.3	54.0	26.0	54.5	58.0

ROBEND 3000/4000/4000 E			at 45°		at 90°		at 180°	
for Ø mm / Inch	Pipe	Bending radius R (mm)	Reserve length L _R mm	Minimum length L _M mm	Reserve length L _R mm	Minimum length L _M mm	Reserve length L _R mm	Minimum length L _M mm
12		42.0	16	-	42	24	42	68
14	wated	52.5	21	-	53	30	53	87
15		52.5	21	-	53	30	53	87
17	wated	72.0	28	-	72	41	72	107
18		72.0	28	-	72	41	72	107
20	wated	88.5	35	-	89	51	89	121
22		88.0	35	-	88	50	88	119
24	wated	112.0	43	-	110	62	110	144
28		112.0	44	-	112	64	112	148
30	wated	112.0	45	-	114	66	114	152
32 / 1.1/4"		128.0	52	-	140	70	135	140
35 / 1.3/8"		140.0	55	-	150	80	145	150
3/8"	steel	12.0	31	-	80	46	80	103
1/2"	copper	45.0	18	-	45	26	45	74
1/2"	steel	88.0	35	-	88	50	88	119
5/8"	copper	56.0	23	-	56	32	56	93
3/4"	steel	112.0	43	-	112	64	112	148
3/4"	copper	80.0	31	-	80	46	80	103
7/8"	copper	88.0	35	-	88	50	88	119
1"	copper	112.0	44	-	112	64	112	148
1.1/8"	copper	112.0	45	-	114	66	114	152



Expanding, extracting, flaring

System overview	80 - 81
Expanding, manual	82 - 86
Expanding, electric	87
Expanding, hydraulic	88 - 89
Accessories expanding	90
Expanding and extracting, manual	91
Extracting, manual	92 - 93
Accessories extracting, manual	94
Flaring	95 - 98
Torque wrench	99

4



Expanding, extracting, flaring

System overview

Expander

**ROLOCK expander
power torque**



Expander A0



Step expander A1



Operation mode:	Manual	Manual	Manual
Working range: Copper	Ø 8-42 mm (5/16-1.3/4") •⊖ 1.6 mm, soft, semi-hard	Ø 22-67 mm (1-2.1/2") •⊖ 2.5 mm, soft, semi-hard	Ø 35-108 mm (1.3/8-4.1/8") •⊖ 2.5 mm, soft
Working range: Aluminium	Ø 8-28 mm (5/16-1.1/8") •⊖ 1.6 mm, soft	Ø 22-67 mm (1-2.1/2") •⊖ 2.5 mm, soft, semi-hard	Ø 35-108 mm (1.3/8-4.1/8") •⊖ 2.5 mm, soft
Working range: Precision steel	Ø 8-28 mm (5/16-1.1/8") •⊖ 1.6 mm, soft	Ø 22-54 mm (1-2.1/8") •⊖ 1.5 mm, soft	–
Working range: Stainless steel	Ø 8-22 mm (5/16-7/8") •⊖ 1 mm, soft	Ø 22-54 mm (1-2.1/8") •⊖ 1.5 mm, soft	–

Page

82 - 83

85

87

H 600



Operation mode:	Hydraulic
Working range: Copper	Ø 8-110 mm (5/16-4.1/4") •⊖ 3 mm, soft, semi-hard
Working range: Aluminium	Ø 8-110 mm (5/16-4.1/4") •⊖ 3 mm, soft, semi-hard
Working range: Precision steel	Ø 8-110 mm (5/16-4.1/4") •⊖ 3 mm, soft, semi-hard
Working range: Stainless steel	Ø 8-110 mm (5/16-4.1/4") •⊖ 3 mm, soft, semi-hard

Page

88

Expander heads

**Expander head
ROLOCK**



**Expander head
standard**



**Expander head
type S**



**Flanged riveted
expander head**



Working range: Copper	Ø 8-42 mm (5/16-1.3/4") +0 1.6 mm, soft, semi-hard	Ø 8-42 mm (5/16-1.3/4") +0 1.6 mm, soft, semi-hard	Ø 22-67 mm (1-2.1/2") +0 2.5 mm, soft, semi-hard	Ø 15-38 mm +0 1.5 mm, soft, semi-hard
Working range: Aluminium	Ø 8-28 mm (5/16-1.1/8") +0 1.6 mm, soft	Ø 8-28 mm (5/16-1.1/8") +0 1.6 mm, soft	Ø 22-67 mm (1-2.1/2") +0 2.5 mm, soft	–
Working range: Precision steel	Ø 8-28 mm (5/16-1.1/8") +0 1.6 mm, soft	Ø 8-28 mm (5/16-1.1/8") +0 1.6 mm, soft	Ø 22-54 mm (1-2.1/8") +0 1.5 mm, soft	–
Working range: Stainless steel	Ø 8-22 mm (5/16-7/8") +0 1 mm, soft	Ø 8-22 mm (5/16-7/8") +0 1 mm, soft	Ø 22-54 mm (1-2.1/8") +0 1.5 mm, soft	–
Page	84	84	86	86

Stufen-Expanderkopf



Working range: Copper	Ø 35-108 mm (1.3/8-4.1/8") +0 2,5 mm, soft, semi-hard
Working range: Aluminium	Ø 35-108 mm (1.3/8-4.1/8") +0 2,5 mm, soft
Working range: Precision steel	–
Working range: Stainless steel	–
Page	87

Expanding, extracting, flaring

Expanding, manual

ROLOCK expander power torque

For expanding, reducing and calibrating soft and semi-hard pipes \varnothing 8 - 42 mm (5/16 - 1.3/4") as well as producing tapers



Product profile

APPLICATION AREA

For efficient, fitting-free installation of pipes in sanitary heating, gas, refrigeration and air-conditioning systems

Suitable for pipes made of:

Copper (soft and semi-hard): \varnothing 8 - 42 mm, 5/16 - 1.3/4"
max. wall thickness 1.6 mm

Aluminium (soft): \varnothing 8 - 28 mm, 5/16 - 1.1/8"
max. wall thickness 1.6 mm

Precision steel (soft): \varnothing 8 - 28 mm, 5/16 - 1.1/8"
max. wall thickness 1.6 mm

Stainless steel (soft): \varnothing 8 - 22 mm, 5/16 - 7/8"
max. wall thickness 1.0 mm

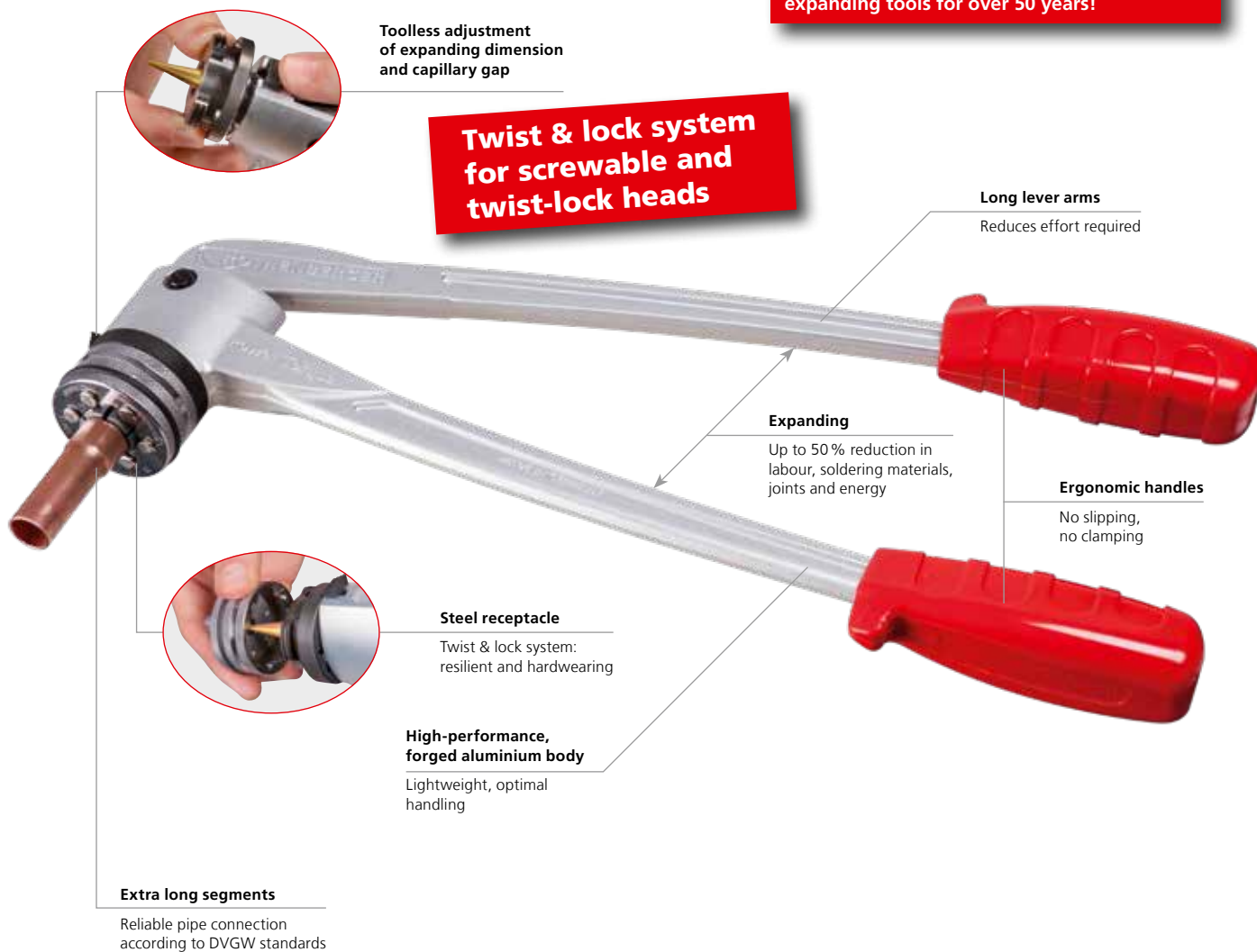
KEY FEATURES

- Eliminates the cost of purchase and storage of fittings
- Converts deformed pipes into fittings; saves resources
- 50% reduction of labour, soldering materials, joints and energy
- Reliable pipe connection according to DVGW standards
- Tough, light and wear-resistant
- Toolless fine adjustment of the capillary gap
- **EPT-Technology – concealed bent lever**

4

Made in Germany!

The know-how from the pioneer of expanding technology and the leading manufacturer of expanding tools for over 50 years!



ROLOCK expander power torque



No.

Expander tool (without expander heads)
for expander heads up to 42 mm / 1.3/4"

1.0

12400

ROLOCK expander power torque sets

ROLOCK expander power torque sets include: expander heads, ROLOCK expander power torque (No. 12400), internal and external deburrer (No. 11006), inlay, carrying case



Fig. similar

EPT-Technology (Enclosed Power Transmission)

The expander head offers the following technical benefits:

Concealed bent lever:

Protection against dirt and external mechanical damage

Energy efficient through optimised force transmission:

Ergonomic, highly optimised force flow in relation to the hand force of the user, therefore reducing effort



4

For efficient, fitting-free installation of pipes



ROLOCK expander power torque sets

Model	kg	No.
12 - 15 - 18 - 22 mm	2.9	12500
12 - 15 - 18 - 22 - 28 mm	3.3	12503
10 - 12 - 16 - 22 - 28 mm	3.3	12505
12 - 14 - 16 - 18 - 22 mm	3.3	12509
10 - 12 - 14 - 16 - 18 - 22 mm	3.6	12511
10 - 12 - 15 - 16 - 18 - 22 - 28 mm	3.6	12537
12 - 14 - 16 - 18 - 22 - 28 - 32 mm	3.7	12538
3/8 - 1/2 - 5/8 - 3/4 - 1"	3.3	12517
3/8 - 1/2 - 5/8 - 3/4 - 7/8 - 1.1/8"	3.6	12518
1/2 - 5/8 - 3/4 - 7/8"	2.9	12521
12 - 16 - 18 - 22 - 28 mm	3.2	12522
1/2 - 5/8 - 7/8 - 1.1/8"	3.0	12524
12 - 15 - 18 - 22 - 28 - 35 - 42 mm	4.2	12526
1/2 - 3/4 - 1"	2.9	12535
3/8 - 1/2 - 5/8 - 3/4 - 7/8 - 1 - 1.1/8"	3.7	12536
3/8 - 1/2 - 5/8 - 3/4 - 7/8 - 1.1/8 - 1.3/8"	4.5	12541

Custom-made products*

ROCAM PE-X expander power torque

For expanding and calibrating PE-X and aluminium multi-layered composite pipe (MLP) up to Ø 42 mm or 1.3/4" as well as producing tapers

Expander heads coordinates with the following systems: ROTEX, SCHELL, TECE / TECEflex, Vulkan-Lokring among others



ACCESSORIES



Description	kg	Description	kg
Expander heads for ROLOCK expander power torque	84	Expander adaptor type S	86
Expander heads type S / riveted expander heads	86	Brazing solder	179
Pipe cutter	14 - 27	High-performance torch (SUPER FIRE 4 with MAPP ¹⁾ gas)	152 - 153
Internal / external deburrer	32		

* Availability, delivery time and price of custom products for other pipe diameters available on request.

¹⁾ MAPP is a registered trademark of the MESSER Group GmbH, Bad Soden

Expanding, extracting, flaring

Expanding, manual

Expander head ROLOCK and standard

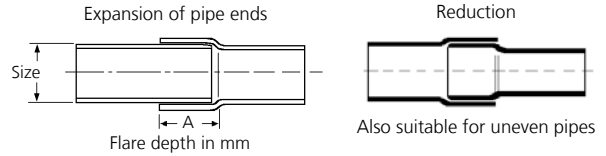
For producing standard precision flares $\varnothing 8 - 42 \text{ mm}$ (5/16 - 1.3/4") according to DVGW standards as well as the specifications for the Gas de France

Made in Germany!
The know-how from the pioneer of expanding technology and the leading manufacturer of expanding tools for over 50 years!

Product profile

KEY FEATURES

- 50% reduction in labour, soldering materials and soldered joints
- Depth of the flare is consistent with DVGW standards
- Compulsory guidance guarantees a perfect centred position and uniform capillary gap
- Robust and long lasting with the hardened segments



4

Specially hardened segments

Robust and long lasting

Step at the end of the segments

Enables recalibration of irregular pipes and fittings

6 rivets and guide channels

Compulsory guidance guarantees a perfect centred position and uniform capillary gap

Extra long segments

Depth of the flare is consistent with DVGW standards



Expander head ROLOCK

Twist & lock system for quick and easy change between nominal diameters



Expander head standard

Standard screwable expander head, still compatible with the ROLOCK Expander



mm	max. wall thickness mm (soft)				A mm	ROLOCK No.	Standard No.
	Cu	Al	Fe	Inox			
8	1.0	1.0	1.0	1.0	6.0	120	12408 11008
10	1.0	1.0	1.0	1.0	10.0	120	12410 11010
12	1.2	1.2	1.2	1.0	12.6	120	12412 11012
14	1.2	1.2	1.2	1.0	12.6	120	12414 11014
15	1.2	1.2	1.2	1.0	15.5	120	12415 11015
16	1.2	1.2	1.2	1.0	15.5	120	12416 11016
18	1.2	1.2	1.2	1.0	17.5	120	12418 11018
20	1.2	1.2	1.2	1.0	17.5	140	12420 11020
22	1.2	1.5	1.5	1.0	20.5	140	12422 11022
28	1.5	1.5	1.5	-	18.5	390	12428 11028
32	1.5	-	-	-	19.5	410	12432 11032
35	1.6	-	-	-	19.5	430	12435 11035
38	1.6	-	-	-	19.5	450	12438 11038
40	1.5	-	-	-	19.5	470	12440 11040
42	1.5	-	-	-	19.5	470	12442 11042

inch	max. wall thickness mm (soft)				A mm	ROLOCK No.	Standard No.
	Cu	Al	Fe	Inox			
5/16"	1.0	1.0	1.0	1.0	6.0	120	12408 11008
3/8"	1.0	1.0	1.0	1.0	7.4	120	12452 11052
1/2"	1.2	1.2	1.2	1.0	11.0	120	12453 11053
5/8"	1.2	1.2	1.2	1.0	14.0	120	12454 11054
3/4"	1.2	1.2	1.2	1.0	18.1	120	12455 11055
7/8"	1.2	1.2	1.2	1.0	18.0	140	12456 11056
1"	1.5	1.5	1.5	-	15.8	150	12457 11057
1.1/8"	1.6	1.6	1.6	-	17.0	390	12458 11058
1.1/4"	1.6	-	-	-	17.0	410	12459 11059
1.3/8"	1.6	-	-	-	17.0	430	12435 11035
1.1/2"	1.6	-	-	-	17.0	450	12438 11038
1.5/8"	1.6	-	-	-	17.5	470	12462 11062
1.3/4"	1.6	-	-	-	17.5	500	12463 11063

Availability, delivery time and price of custom products for other pipe diameters available upon request.

Suitable for ROTHENBERGER ROLOCK expander power torque

Description		Description	
ROLOCK expander power torque	82	ROCASE 4414 red, without inlay	335
ROLOCK COMBI KIT expander / tee-extractor	91		

Expander A0

For expanding, reducing and calibrating thick walled pipes \varnothing 22 - 67 mm (1 - 2.1/2") as well as the production of tapers

Product profile

APPLICATION AREA

Suitable for pipes made of:

Copper and aluminium:
(soft, semi-hard)

\varnothing 22 - 67 mm, 1 - 2.1/2"
max. wall thickness 2.5 mm

Precision steel (soft):
and stainless steel per
DVGW-GW541

\varnothing 22 - 54 mm, 1 - 2.1/8"
max. wall thickness 1.5 mm

Functional elements:

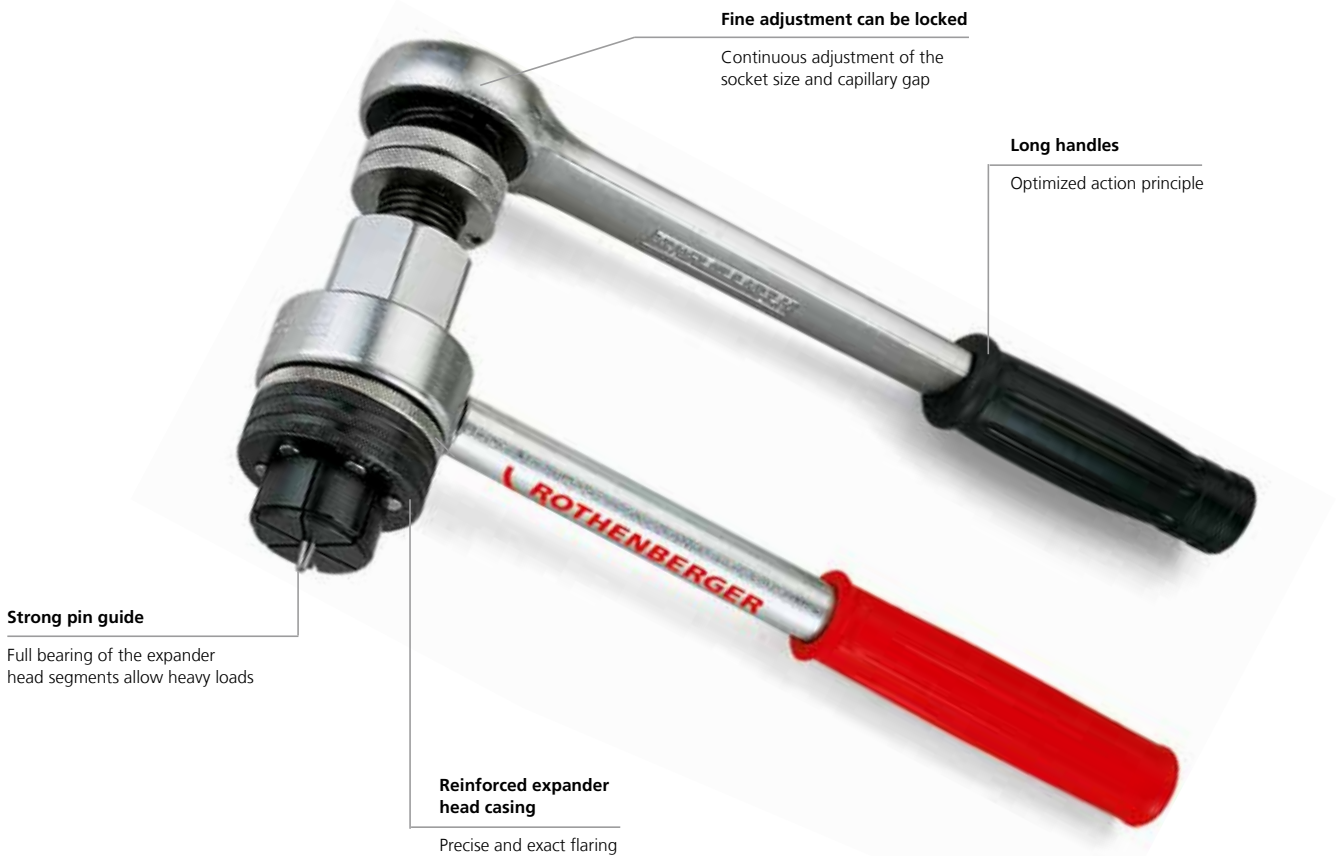
Expander A0 with a tightly guided and reinforced, long expander head, matches to the expander head type S!

KEY FEATURES

For efficient, fitting-free installation of pipes in sanitary heating, gas, refrigeration and air-conditioning systems

- Application and savings advantages similar to ROLOCK expander power torque
- Precise and exact flaring
- Full bearing of the expander head segments allows heavy loads
- Continuous adjustment of the socket size and capillary gap
- Optimized action principle with long handles

4



Strong pin guide

Full bearing of the expander head segments allow heavy loads

Reinforced expander head casing

Precise and exact flaring

Fine adjustment can be locked

Continuous adjustment of the socket size and capillary gap

Long handles

Optimized action principle

Expander A0 set (No. 11400) includes: expander head type S, special ratchet (No. 27181)

Expander A0 basic unit (No. 11004) includes: square drive mechanism 3/4" with handle, without expander head and ratchet

Model	Size	kg	No.
Expander A0 set	35 - 42 - 54 - 64 mm	8.12	11400
Expander A0 basic unit		1.97	11004



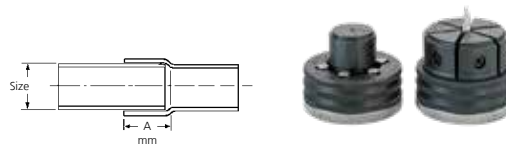
Fig. similar

Expanding, extracting, flaring

Expanding, manual

Expander head type S

For the precise expansion of normal and thick walled pipes \varnothing 22 - 67 mm (1 - 2.1/2") and 2.5 mm wall thickness



Accurate guidance of the segments through the reinforced expander head casing

4

mm	max. wall thickness mm				A-size mm	g	No.
	Cu	Al	Fe	Inox			
22	2.0	2.0	1.5	1.5	18.5	350	11323
25	2.0	2.0	1.5	1.5	18.5	350	11325
28	2.0	2.0	1.5	1.5	19.5	360	11328
32	2.0	2.0	1.5	1.5	19.5	380	11332
35	2.0	2.0	1.5	1.5	19.5	400	11335
36	2.0	2.0	1.5	1.5	19.5	400	11336
42	2.0	2.0	1.5	1.5	19.5	450	11342
54	2.5	2.5	1.5	1.5	19.5	570	11346
64	2.5	2.5	-	-	19.5	690	11348
67	2.5	2.5	-	-	19.5	730	11380

inch	max. wall thickness mm				A-size mm	g	No.
	Cu	Al	Fe	Inox			
1"	2.0	2.0	1.5	1.5	18.5	350	11376
1.1/8"	2.0	2.0	1.5	1.5	19.5	360	11358
1.1/4"	2.0	2.0	1.5	1.5	19.5	380	11332
1.3/8"	2.0	2.0	1.5	1.5	19.5	400	11335
1.5/8"	2.0	2.0	1.5	1.5	19.5	450	11362
2"	2.0	2.0	1.5	1.5	17.0	540	11364
2.1/8"	2.5	2.5	1.5	1.5	17.0	570	11346
2.1/2"	2.5	2.5	-	-	17.0	690	11348

Expander adaptor type S

To increase the application area of the ROCAM / ROLOCK expander power torque, ROMAX expander compact standard and expander pistol H1



Allows the use of the expander heads type S with copper pipe (soft) up to 67 mm and/or 2.1/2"!

Model	max.	max. mm	g	No.
Adaptor type S, without expander head	67 mm and/or 2.1/2"	2.0	630	11007

Flanged riveted expander heads

For use with the ROCAM / ROLOCK expander power torque, ROMAX expander compact standard and expander pistol H1



Product profile

APPLICATION AREA

For producing exact hose connections, for example vibrating power units in

- Air-conditioning technology
- Auto manufacturing
- Industrial applications

mm	mm	Outer dia.-flange mm	Distance flange pipe end mm	g	No.
15	1.5	18	4	110	11955
18	1.5	21	4	110	11958
22	1.5	25	6	120	11962
28	1.5	31	6	370	11968
35	1.5	38	6	400	11975

Step expander A1

For expanding, reducing and calibrating thick walled pipes, Ø 35 - 108 mm (1.3/8 - 4.1/8") as well as the production of tapers

Product profile

APPLICATION AREA

For efficient, fitting-free installation of pipes in sanitary, heating, gas, refrigeration and air-conditioning systems

Suitable for pipes made of:

Copper and aluminium: Ø 35 - 108 mm, 1.3/8 - 4.1/8"
(soft) max. wall thickness 2.5 mm

KEY FEATURES

- Affordable alternative when laying larger pipe dimensions with a considerable saving of soldering materials
- Expand without changing tools with the 6 size step expander
- Full bearing of the expander head segments allows heavy loads
- Optimum adjustment of the socket size and capillary gap with the positive fine adjustment
- Optimised force transmission with the trapezoidal screw thread with self-lubricating bronze socket
- Compulsory guidance guarantees a perfect centred position and uniform capillary gap with 6 rivets and guiding ridge



Fig. similar special ratchet (No. 27181)

Sets include: step expander with handle, without special ratchet



Size	kg	No.
42 - 54 - 64 - 76.1 - 88.9 - 108 mm	4.2	11086
35 - 42 - 54 - 64 - 76 - 108 mm	3.9	11087
35 - 42 - 54 - 67 - 80 - 104 mm	3.9	11089
1.3/8 - 1.5/8 - 2.1/8 - 2.5/8 - 3.1/8 - 4.1/8"	4.2	11078
1.1/4 - 4"	3.8	11093

Expanding, extracting, flaring

Expanding, hydraulic

Hydraulic expander system H 600

For expanding, reducing and calibrating normal and thick walled pipes in batch production as well as the production of tapers



Product profile

APPLICATION AREA

Suitable for normal and thick walled pipes made of:

Copper and aluminium: Ø 8 - 110 mm, 5/16 - 4.1/4" max. wall thickness 3.0 mm

Precision and stainless steel: Ø 8 - 110 mm, 5/16 - 4.1/4" max. wall thickness 3.0 mm

KEY FEATURES

- Individual modular design
- Industrial quality expansions
- Proper and efficient handling of material

TECHNICAL DATA

Rated power:	1.2 kW
Rated current:	2.1 A
Operating pressure:	80 - 600 bar
Max. operating pressure:	700 bar
Delivery capacity:	0.82 l / min
Safety category:	IP 54
Actuation:	400 V / 1,200 W

4



Set (No. 13100) includes: Electro-hydraulic expander system H 600 complete with hydraulic unit H 600 (No. 13002), expander pistol H 1 (No. 12001), control cable, hydraulic hose 2.5 m with circuit points, adjusting tool, tool rack (No. 13023), safety foot pedal and hydraulic oil 1 l (No. 58185), without expander heads

Set (No. 13002) includes: Electro-hydraulic unit H 600 with safety foot pedal, adjusting tool, tool rack (No. 13023) and hydraulic oil 1 l (No. 58185), without expander heads

Model	kg	No.
Hydraulic expander system H600	36.0	13100
Hydraulic unit H 600	33.1	13002
Safety foot pedal with 3 m cable	0.5	12013

Electro-hydraulic expander pistol H1

Product profile

APPLICATION AREA

Expander heads standard:	Ø 8 - 42 mm, 5/16 - 1.3/4" max. wall thickness 1.6 mm
Expander heads type S: (with adaptor No. 11007)	Ø 22 - 67 mm, 1 - 2.1/2" max. wall thickness 2.5 mm

Set includes: 2.5 m control cable (No. F88928), hydraulic hose (No. 12023), adjusting tool (No. 12017), hydraulic oil 1 l (No. 58185)

Description	kg	No.
Electro-hydraulic expander pistol H1	2.9	12001
Adaptor H1 / type S	0.6	11007
Adjusting tool for H1	0.9	12017

ACCESSORIES

Description	kg	No.
Expander head H2 / type 2, 28 - 70 mm	2.5	12078
Expander head H2 / type 3, 70 - 110 mm	3.0	12080
Adaptor H2 / type S	1.1	12097
Adjusting tool for H2	0.9	12018



Adaptor
(No. 12097)



Adjusting tool
(No. 12018)



Expander pistol H1
(No. 12001)

Adaptor (No. 11007)

Expander adaptor type S

To increase the application area of the ROCAM expander power torque, expander pistol H1/H2, expander A0/A1 and ROMAX expander compact



Expander adaptor (No. 11007) for ROCAM expander power torque or expander pistol H1



Expander adaptor (No. 12097) for expander pistol H2














Allows the use of the expander heads type S with copper pipe (soft) up to 67 mm and/or 2.1/2"!

Model	max.	max. mm	kg	No.
Adaptor type S, without expander heads	67 mm and/or 2.1/2"	2.0	0.6	11007
Adaptor H2/type S	70 - 110 mm		1.1	12097

Expanding, extracting, flaring

Accessories expanding

Expander head compatibility

	Expander head ROLOCK	Expander head standard	Expander head type 5	Riveted expander head	Expander head PE-X	Expander head H2, type 2 and 3	Step expander head
ROLOCK expander power torque 	●	●		●	○	○	○
ROCAM expander power torque 	○	●		●	● No. 12005	○	○
Expander A0 	○	○	●	○	○	○	○
Expander A1 	○	○	○	○	○	○	●
ROMAX expander compact 	○	● No. 15714	 No. 15714 ● No. 15715	● No. 15714	● No. 15716	○	○
ROMAX expander AC ECO MAXI 	○	○	○	○	○	○	●
Expander pistol H1 	○	●		●	○	○	○
Expander pistol H2  Fig. similar	○	○		○	○	●	○

● Expander head can be used without adaptor ○ Expander head can not be used

Fig.: Can be used with the appropriate adaptor (pictured)

Expanding, extracting, flaring

Expanding and extracting, manual

ROLOCK COMBI KIT expander / tee-extractor

Practical, compact and cost-saving set combinations with ROLOCK expander power torque and tee-extractors. For all common pipe dimensions \varnothing 12 - 28 mm (1/2 - 1.1/8")

Made in Germany!

The know-how from the pioneer of expanding technology and the leading manufacturer of expanding tools for over 50 years!



Product profile

APPLICATION AREA

Suitable for pipes made of:

**Copper, aluminium
and steel (soft):**

\varnothing 12 - 28 mm, 1/2 - 1.1/8"

KEY FEATURES

- Increases safety by reducing the number of connections
- Suitable for making branches even in confined spaces through the compact design

KEY FEATURES

- Toolless fine adjustment of the capillary gap
- Reduces effort required and increases work space
- Up to 67% reduction of soldering materials and soldered joints
- Accurate drilling
- Saves resources by converting scrap pipes into fittings
- Reliable pipe connections to DVGW standards

4



EPT-Technology

Concealed bent lever

Largest possible expansion size
and toolless adjustable capillary gap

Professional extractions

Up to 67% reduction of
soldering materials and
soldered joints

Long handles

Reduces effort
required and
increases work space

Utilisation of material

Saves resources by converting
scrap pipes into fittings

UNIDRILL Automatic 28/42

Accurate drilling

No. 21583 /
No. 21575

Scale and cam depth adjustment

Extractor cam pincer

Limits insertion depth for
 \varnothing 12 - 42 mm (1/2 - 1.5/8")

No. 22080



Fig. similar

ROLOCK COMBI KIT sets include: ROLOCK expander power torque (No. 12400), ROLOCK expander heads, tee-extractor, special ratchet (No. 27180), adaptor (No. 150002894), UNIDRILL Automatic 28 (No. 21583), extractor cam pincer (No. 22080), carrying case

Model	Description	kg	No.
ROLOCK COMBI KIT	12 - 15 - 18 - 22 mm	4.4	12601
ROLOCK COMBI KIT	12 - 14 - 16 - 18 mm	2.6	12602
ROLOCK COMBI KIT	1/2 - 5/8 - 7/8 - 1.1/8"	2.8	12604
ROLOCK COMBI KIT	1/2 - 3/4 - 1	2.5	12605

Expanding, extracting, flaring

Extracting, manual

Tee-extractor sets

For efficient production of T-branches (extractions) for fitting-free pipe installations, Ø 10 - 42 mm (3/8 - 2.1/8")

Made in Germany!

The know-how from the pioneer of expanding technology and the leading manufacturer of expanding tools for over 50 years!



Product profile

APPLICATION AREA

Suitable for pipes made of:

Copper (soft, semi-hard, hard): Ø 10 - 42 mm, 3/8 - 2.1/8" max. wall thickness 2.5 mm

Aluminium: Ø 10 - 42 mm, 3/8 - 2.1/8" max. wall thickness 2.5 mm

Precision steel: Ø 10 - 42 mm, 3/8 - 2.1/8" max. wall thickness 2.5 mm

KEY FEATURES

- Eliminates the cost for T-pieces, purchase and storage of fittings
- Extractions even on installed pipes possible
- Accurate drilling
- Optimal positioning with the cam pincher depth adjustment

Scale and cam depth adjustment

4



Limits the insertion depth

Optimal positioning

No pipe removal

Extractions even on installed pipes possible

Extractor cam pincher

Limits insertion depth for Ø 12 - 42 mm (1/2 - 1.5/8")

No. 27180

Optimum capillary gap

Professional extractions

UNIDRILL Automatic 28/42

Accurate drilling

No. 21583 / No. 21575



Fig. similar

Tee-extractor sets include: tee-extractor according to chart, special ratchet (No. 27180), adaptor (No. 1500002894), cam pincher (No. 22080) and special conical drill, UNIDRILL Automatic 42 (No. 21575), carrying case

Model	Description	kg	No.
Tee-extractor set 12 - 15 - 18 - 22 mm		3.4	22100
Tee-extractor set 12 - 15 - 22 - 28 mm		3.6	22101
Tee-extractor set 12 - 15 - 18 - 22 - 28 mm		3.9	22103
Tee-extractor set 12 - 14 - 16 - 18 - 22 mm		3.6	22109
Tee-extractor set 10 - 12 - 14 - 16 - 18 - 22 mm		3.7	22111
Tee-extractor set 12 - 15 - 18 - 22 - 28 - 35 - 42 mm		5.5	22126
Tee-extractor set 15 - 22 - 28 mm		3.6	22127
Tee-extractor set 1/2 - 5/8 - 3/4 - 7/8"		3.4	22121
Tee-extractor set 1/2 - 5/8 - 7/8 - 1.1/8"		3.7	22124
Tee-extractor set 1/2 - 3/4 - 1"		3.3	22135

Tee-extractor

Tee-extractor with double V-block for accurate 90° branches, Ø 10 - 54 mm (3/8 - 2.1/8")

Product profile

KEY FEATURES

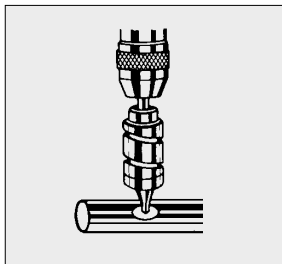
- Uniform and proper material extraction without scratches or burrs
- Burr-free operation with the specially polished extractor hooks
- Easy insertion into the drilled hole with the special trapezoidal screw thread
- Accurate and firm positioning for exact 90° branches

mm / inch	mm	Drill Ø mm	mm	g	No.
10	1.0	6	11	130	22010
12	1.0	7	11	150	22012
14	1.0	8	11	160	22014
15	1.0	8	11	160	22015
16	1.0	8	11	220	22016
18	2.0	10	11	220	22018
28	2.5	15	11	470	22028
35	2.5	22	11	700	22035
38	2.5	22	11	700	22038
42	2.5	26	11	890	22042
54	2.5	30	19	1,380	22054
3/8"	1.0	6	11	110	22060
1/2"	1.0	7	11	140	22061
5/8"	1.0	8	11	220	22016
3/4"	2.0	10	11	220	22062
7/8"	2.0	12	11	350	22063

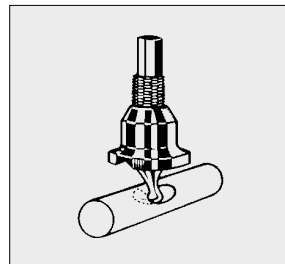
hexagon square

mm	g	No.	inch	g	No.
10	60	1300005045	3/8"	60	1300005058
12	70	1300005046	1/2"	70	1300005059
14	90	1300005047	5/8"	140	1300005049
15	90	1300005048	3/4"	140	1300005060
16	140	1300005049	7/8"	200	1300005061
18	140	1300005050	1"	210	1300005062
22	210	1300005051	1.1/8"	220	1300005063
28	220	1300005052	1.1/4"	270	1300005064
35	290	1300005054	1.3/8"	290	1300005054
38	290	1300005055	1.1/2"	290	1300005055
42	320	1300005056	1.5/8"	320	1300005065
54	560	1300005057	2"	520	1300005067
			2.1/8"	560	130000507

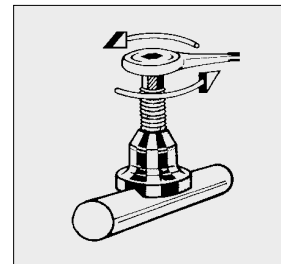
Precise drilling of the pipe without a centre punch – drill stop prevents perforation of the pipe



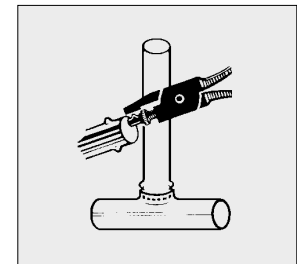
Insert extractor hook into the drilled hole and screw the bell firmly against the drill hole



Using the ratchet, turn the extractor to the left, while paying attention that the V-block is seated securely



After extraction, set correct insertion depth (dependant on pipe Ø) with cam pincer



Simply calibrate the tee Ø on the UNIDRILL Automatic and the drilled hole Ø will automatically correspond to the extractor hook required.

Double V-block

Accurate and firm positioning for exact 90° branches



Specially polished, forged and tempered extractor hooks

Burr-free operation

Special hook design

Easy insertion into the drilled hole



Ratchet adaptor (No. F80053 and F80054) with No. 22050 / 22054 included in scope of delivery (square, 3/4")

mm / inch	mm	Drill Ø mm	mm	g	No.
1"	2.5	14	11	470	22064
1.1/8"	2.5	15	11	480	22065
1.1/4"	2.5	19	11	700	22066
1.3/8"	2.5	22	11	700	22035
1.1/2"	2.5	22	11	700	22038
1.5/8"	2.5	26	11	900	22068
2"	2.5	30	19	1,380	22050
2.1/8"	2.5	30	19	1,380	22054

Accessories

Socket 19 mm

F80053

Square connection 3/4"

F80054

Spare extractor hooks

Hooks, specially polished, tempered from Ø 10 - 54 mm (3/8 - 2.1/8")



Note: For copper pipes (soft), the use of an extractor support is recommended! (94)

Expanding, extracting, flaring

Accessories extracting, manual

Tee-extractor ratchet

Chrome vanadium steel, fine toothed and right/left reversible



No. 27180
Fig. similar

No. 150002894
Adaptor for the use with extractor



No. 27181

Model	SW	g	No.
10 - 42 mm, 3/8 - 1.3/4"	3/4" ■	435	27180
50 - 54 mm, 2 - 2.1/8"	3/4" ■	1,140	27181

Extractor cam pincer

KEY FEATURES

- Identification point marks insertion depth exactly and prevents over-insertion
- Cam depth adjustment wheel with scale



mm	inch	mm	g	No.
12 - 42	1/2 - 1.5/8"	150	170	22080

4

UNIDRILL Automatic 28/42

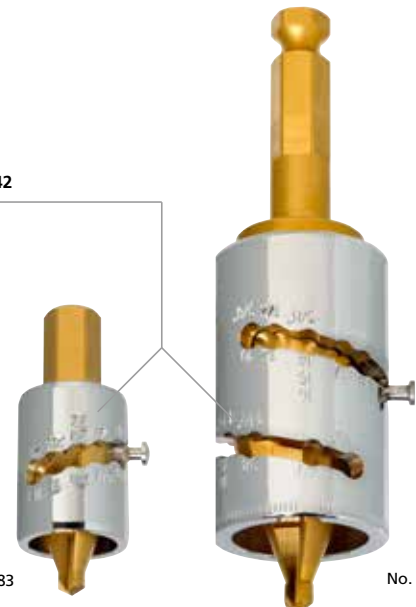
HSS special conical drill

KEY FEATURES

- Fast, burr-free drilling
- Precise location without need for centre punch special drill tip
- Calibrated drill Ø automatically corresponds to the correct extractor hook and branch size
- Drill stop prevents damage to pipe walls

UNIDRILL Automatic 28/42

Accurate drilling



No. 21583

No. 21575



Model	mm	inch	SW	g	No.
UNIDRILL 28	10 - 28	3/8 - 1.1/8"	11	110	21583
UNIDRILL 42	10 - 42	3/8 - 1.5/8"	11	430	21575

Precision double flaring press DB 10

For standard precision expands according to DIN 74234
 Ø 4.75 - 10 mm, wall thickness 0.7 - 1.0 mm

Product profile

APPLICATION AREA

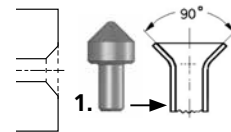
On copper, aluminium and steel pipes, seamless pipes and double-walled pipes, for example Bundy pipe and KUNIFER brake pipes

KEY FEATURES

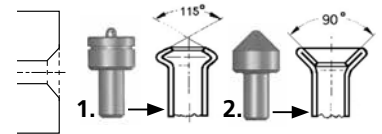
- Ideal for endless pipes
- For several flaring profiles, wall thickness 0.7 - 1.0 mm
- Universal use with the pluggable pressure cone
- Accurate and reproducible results
- Clamping block for several pipe diameters
- Reliable hold with the 25 mm pipe clamping length
- Suitable for clamping in a vice

Formation of the various flares made possible with the appropriate flaring attachments

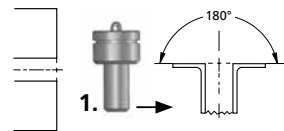
E- contour, simple flare:
 ● Standard flaring contour



D-contour, double flare:
 ● Extension of brake and/or hydraulic lines
 ● Connection by means of coupling rings, sealed by means of flaring surface



180° flares:
 ● Mounting using coupling ring, for example hydraulic transmission valve and/or distributor block
 ● Seal between drill-hole and flaring surface



4



Set (No. 26013) includes: basic tool with pressure cone (No. 26010), flaring attachments, 1 set of clamping blocks (No. 26011)

Description	mm	kg	No.
DB 10 set	4.75 - 5 - 6 - 8 - 9 - 10 mm	2.64	26013
Flaring attachment	4.75 / 5 mm	0.20	26001
Flaring attachment	6 mm	0.20	26002
Flaring attachment	8 mm	0.20	26003
Flaring attachment	9 mm	0.20	26004
Flaring attachment	10 mm	0.20	26005

Description	mm	g	No.
Pressure cone		20	26010
Clamping spindle		90	26015
Flaring spindle		300	26016
Distance bolt		30	26017
Set of clamping blocks (2 pcs.) for pipes	4.75 - 5 - 6 - 8 - 9 - 10 mm	190	26011

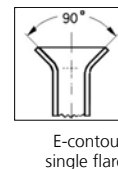
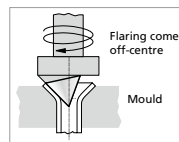
Expanding, extracting, flaring

Flaring

ROFLARE REVOLVER

Revolver reeling flaring tool

For the reliable and fast production of standard single 45° flares in accordance with EN 14276-2 and JIS B8607:2008 on copper soft pipes Ø 6 - 18 mm and 1/4 - 3/4"



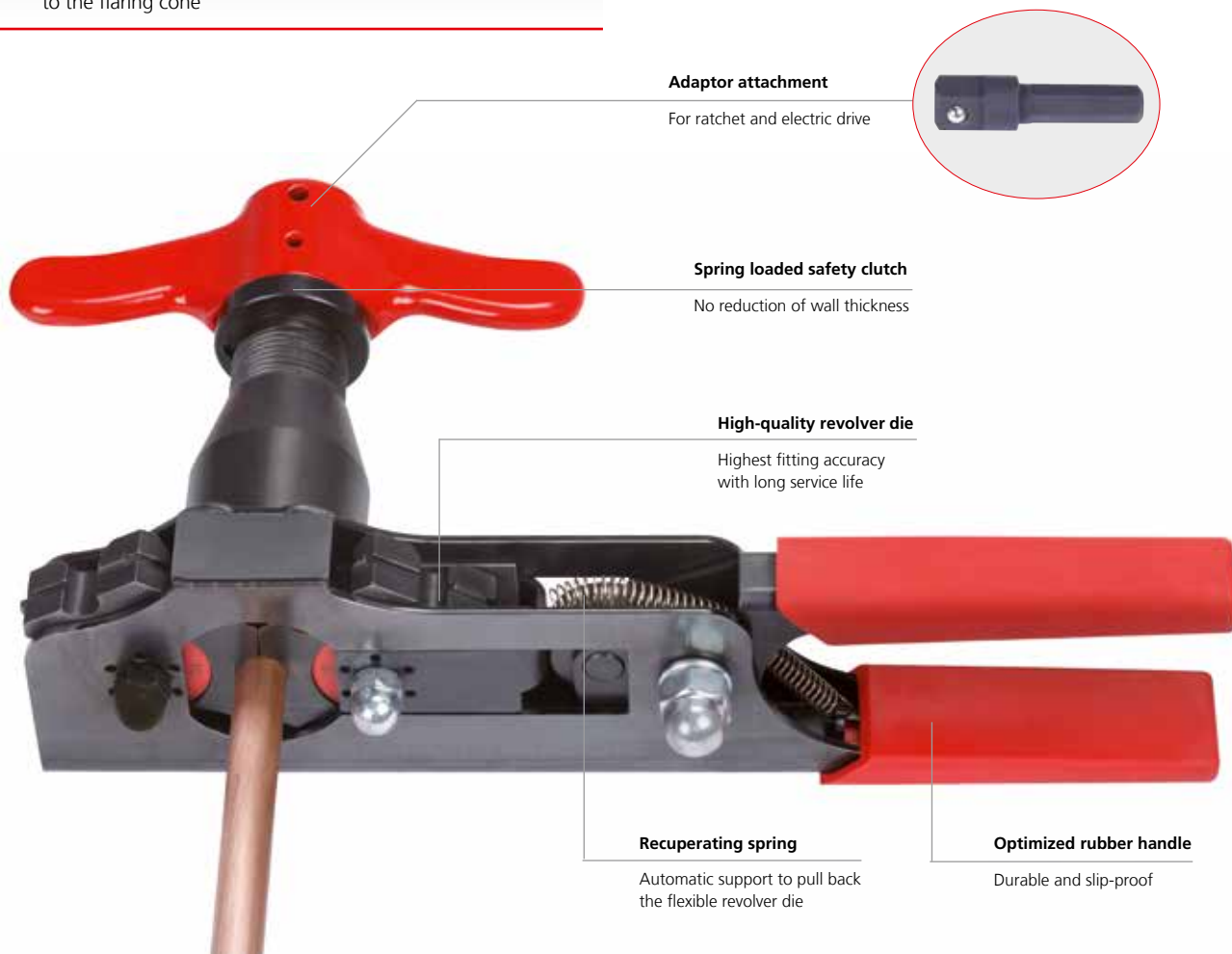
E-contour single flare

Product profile

KEY FEATURES

- Guaranteed norm flares
- Produces leak free joints
- One-handed quick clamping system
- **Automatic depth stop:** perfect positioning of the pipe to the flaring cone

4



Adaptor attachment

For ratchet and electric drive



Spring loaded safety clutch

No reduction of wall thickness

High-quality revolver die

Highest fitting accuracy with long service life

Recuperating spring

Automatic support to pull back the flexible revolver die

Optimized rubber handle

Durable and slip-proof

Set (No. 100000230) includes: ROFLARE REVOLVER metric incl. ratchet adaptor, dies Ø 6, 8, 10, 12, 16 and 18 mm, pipe cutter ROTRAC 28 PLUS chrome limited edition (No. 100000046), ROCASE 4212 (No. 1300003334)

Set (No. 100000231) includes: ROFLARE REVOLVER imperial incl. ratchet adaptor, dies Ø 1/4, 5/16, 3/8, 1/2, 5/8 and 3/4", pipe cutter ROTRAC 28 PLUS chrome limited edition (No. 100000046), ROCASE 4212 (No. 1300003334)

Description	No.
Set, metric with ROTRAC 28 PLUS chrome limited edition	100000230
Set, imperial with ROTRAC 28 PLUS chrome limited edition	100000231
Metric, Ø 6, 8, 10, 12, 16, 18 mm	100000222
Imperial, Ø 1/4, 5/16, 3/8, 1/2, 5/8, 3/4"	100000223

Compact design enables use in confined spaces

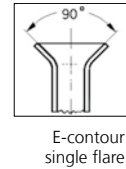
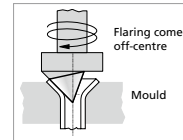


Automatic depth stop: perfect positioning of the pipe to the flare cone



Reeling flaring tool

For producing precise 45° single flares on copper pipes
 Ø 6 - 18 mm (1/8 - 3/4")



Product profile

KEY FEATURES

- Controlled expanding and shaping of the pipe without tearing
- No reduction in wall thickness
- No slipping of the pipe
- Sturdy and long lasting

4



Fig. similar

Reeling flaring tool set includes: reeling flaring tool in plastic case with mould in metric and/or imperial format

Model	mm / inch	No.
Set EB	6 - 8 - 10 - 12 - 14 - 15 - 16 - 18 mm 1/8 - 3/16 - 1/4 - 5/16 - 3/8 - 1/2 - 5/8 - 3/4"	222401
Set EB	1/8 - 3/16 - 1/4 - 5/16 - 3/8 - 1/2 - 5/8 - 3/4"	222402
Set EB	6 - 8 - 10 - 12 - 14 - 15 - 16 - 18 mm	222403
Dies		
Metric	6 - 8 - 10 - 12 - 14 - 15 - 16 - 18 mm	222413
Imperial	1/8 - 3/16 - 1/4 - 5/16 - 3/8 - 1/2 - 5/8 - 3/4"	222412

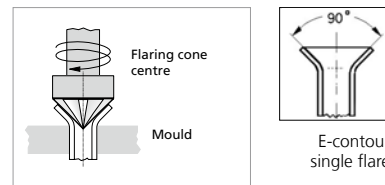
Expanding, extracting, flaring

Flaring

Universal flaring tool

For producing precise 45° single flares on copper pipes Ø 4 - 16 mm (3/16 - 5/8")

- Universal application and highest flare precision through self-centring pipe clamp for all diameters
- Controlled flaring without tearing, forming perfect surfaces
- Hardened flare cone with special geometry



Universal flaring tool set (No. 222601) includes: universal flaring tool for pipe diameters 4 - 16 mm, 3/16 - 5/8", in plastic case

Model	mm	inch	g	No.
Set EB	4 - 16 mm	3/16 - 5/8"	900	222601

Flaring and bending set

Universal application in industry and small trade by sanitary and heating installations, refrigeration and air-conditioning technology, auto and hydraulic technology



Fig. similar

Flaring and bending set (No. 26020) includes: MINICUT I, Ø 3 - 16 mm (No. 70401), internal and external deburrer, Ø 4 - 36 mm (No. 11006), double flare press DB 10 (No. 26013), TUBE BENDER set, Ø 4.75 - 10 mm (No. 24112)

Model	mm	kg	No.
Flaring / bending set	4.75 - 5 - 6 - 8 - 9 - 10	5.5	26020

Expanding, extracting, flaring

Torque wrench

ROTORQUE AIRCON / REFRIGERATION

Step-less torque wrench

Product profile

APPLICATION AREA

Self-locking rack and pinion drive enables quick and reliable fastening of flare nuts sizes 15 - 32 mm in accordance with EN 378-2:2012-08

KEY FEATURES

- Always fits, covers all flare nut sizes from 15 - 32 mm
- Won't slip thanks to the self-locking rack and pinion drive and ratchet function
- Simple and reliable: required torque in accordance with EN 378-2:2012-08 is embossed on the head for every size and can not be rubbed off
- Embossed torque data: easy tightening according to norm
- ROTORQUE REFRIGERATION is suitable for cylinder heads' work

Connection 9 x 12

Head can be exchanged between ROTORQUE AIRCON and ROTORQUE REFRIGERATION

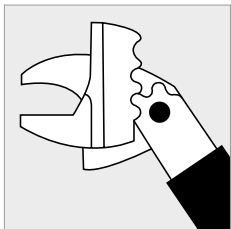
All-In-One: one head fits all sizes!



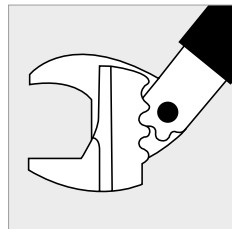
The torque can be read off

Always tighten according to the standard

Closed head



Fully opened head



ROTORQUE AIRCON torque wrench

- 10 – 110 Nm
- ± 4% accuracy
- 1 Nm adjustment steps

ROTORQUE REFRIGERATION torque wrench

- 10 – 70 Nm
- ± 3% accuracy
- 1/2 Nm adjustment steps
- Suitable for cylinder heads' work



Fig. ROTORQUE AIRCON torque wrench



Fig. ROTORQUE REFRIGERATION torque wrench

ROTORQUE sets include: torque wrench, head, carrying bag

Model	kg	No.
ROTORQUE AIRCON	1.5	100000224
ROTORQUE REFRIGERATION	1.4	100000225

Torque wrench set

For proper tightening of flange connections

Set with adjustable torque wrench (10-70 Nm) and 6 spanner inserts sizes 17, 22, 24, 26, 27 and 29 mm for flange connections on 1/4", 3/8", 1/2" and 5/8" pipe lines according to DIN EN 378-2 : 2012-08



Fix with torque urgently necessary!



Fig. similar

7 pieces set (No. 175001) includes: spanner wrench sizes 17, 22, 24, 26, 27, 29 mm, torque wrench, carrying bag

Pipe-Ø	Spanner width	Locking torque
1/4" / 6 mm	17 mm	14 - 18 Nm
3/8" / 10 mm	22 mm	33 - 42 Nm
1/2" / 12 mm	24 mm	50 - 62 Nm
1/2" / 12 mm	26 mm	50 - 62 Nm
5/8" / 15/16 mm	27 mm	63 - 77 Nm
5/8" / 15/16 mm	29 mm	63 - 77 Nm

Model	kg	No.
Torque wrench set, 7 pcs.	3.5	175001



Pressing

System overview	102 - 103
Press machine compact	104 - 105
Conex Bänninger »B« MaxiPro press system	106 - 107
Press machines standard	108 - 111
DURA LAZR TEC	112
Press jaws compact	113 - 114
Press jaws standard	114 - 115
Press chains standard	116
Overview press jaws	117 - 118
Pressnavigator app	118
Overview system approvals	119 - 123

Press machines



ROMAX Compact TT (Twin Turbo)



ROMAX 4000



ROMAX 3000 AC



ROMAX AC ECO



Operation mode:	Electro-hydraulic	Electro-hydraulic	Electro-hydraulic	Electro-hydraulic
Jaw fixture rotatable:	270°	270°	270°	270°
Constant Force Technology (CFT):	✓	✓	✓	✓
Controlled press cycle:	✓	✓	✓	–
Piston force / hub:	19 kN / 30 mm	32 kN / 40 mm	32 kN / 40 mm	32 kN / 40 mm
Service interval:	40,000 pressings	40,000 pressings	20,000 pressings	10,000 pressings
LED:	✓	✓	✓	–
Approx. pressing cycle time:	3 s	5 s	5 s	7 s
Dimensions:	336 x 143 x 76 mm	445 x 125 x 75 mm	460 x 120 x 90 mm	415 x 180 x 80 mm
Cable length:	–	–	5 m	5 m
Weight:	2.5 kg	3.6 kg	3.8 kg	4.5 kg
Battery:	✓	✓	–	–
Page:	104 - 105	108 - 109	110	111

ROTHENBERGER Constant Force Technology

The CFT guarantees a constant axial pressing force over the entire service interval. A very important requirement for the production of sealed press connections.

CFT guarantees:

ROMAX Compact TT 19 kN / 40,000 press cycles

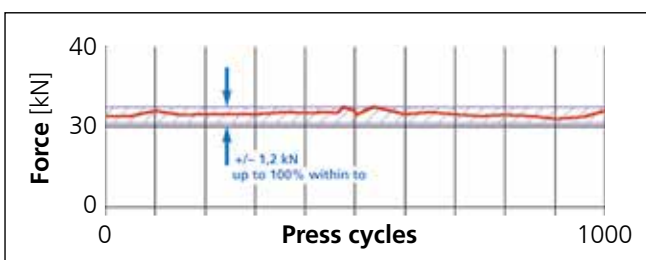
ROMAX 4000 32 kN / 40,000 press cycles

ROMAX 3000 AC 32 kN / 20,000 press cycles

ROMAX AC ECO 32 kN / 10,000 press cycles

Constant Force Technology

Measurement under load – UPONOR NW 75



Cordless Alliance System

- 100% compatibility of machines, battery packs and chargers – cross-manufacturer
- World's most powerful battery pack system with 30 years of battery pack competence from Metabo
- Maximum reliability, clear cost advantages and high investment reliability.
- Cordless Alliance System (CAS) is an alliance of leading power tool brands.
- CAS partner: ROTHENBERGER, Metabo, Mafell, Collomix, Eibenstock, Eisenblätter, Haaga, Starmix, Steinel, Rokamat, Birchmeier, Edding, Fischer, Prebena, Cembre, Pressfit and Jöst.



Press jaws / Press chains / Press rings



ROTHENBERGER
Pressnavigator

	Press jaws compact	Interchangeable press jaws compact	Press jaws standard	3-elemental press jaws	Press chains standard	Press rings
Working range metal:	Ø 12 - 35 mm	–	Ø 12 - 54 mm	Ø 42 - 54 mm	Ø 42 - 54 mm	Ø 42 - 54 mm
Working range multi-layer:	Ø 12 - 40 mm	Ø 12 - 32 mm	Ø 12 - 40 mm	Ø 50 - 63 mm	Ø 40 - 110 mm	–
Snap on:	–	–	–	–	✓	✓
DURA LAZR TEC:	✓	–	✓	✓	✓	✓
Long-term corrosion prot.:	✓	✓	✓	✓	✓	✓
3-bolt synch. mechanism:	✓	✓	✓	✓	–	–
Precision-manufactured contour:	✓	✓	✓	✓	✓	✓
Compatible with Conex Bänninger ›B‹ MaxiPro press fitting system:	✓	–	✓	–	–	✓
Suitable for all press machines with a compatible press jaw fixture and a constant axial thrust of:	19 – 21 kN	19 – 21 kN	32 – 34 kN	32 – 34 kN	32 – 34 kN	19 – 21 kN und 32 – 34 kN
Page:	113	114	114	115	116	106

5

No system commitment

Users are free to decide which fitting systems they want to press. They are also free to choose the manufacturer of the press machines and press tools. There is no legal provision, DIN standard or other provision - for example, a regulation established by means of a DVGW worksheet - which obligates the tradesmen to exclusively use the press tools or press jaws of just one fitting or piping system manufacturer.

The only decisive factor is whether the fitting system and pressing tool are suitable for one another - only in this case is the tightness guaranteed. The Pressnavigator app provides guidance by enabling users to find the suitable press tool for the fitting system, or the suitable fitting system for the press tool.

Controlled press cycle

After reaching a predetermined pressing force the press cycle switches off automatically. The piston retracts after the necessary pressing force has been reached. This guarantees uniform and reliable pressings as leading system manufacturers require.

Electronic control

The electronics of the ROMAX Compact TT, ROMAX 4000 and ROMAX 3000 AC provide for a safe pressing cycle:

- Control of the battery charge status
- Safety start-inhibitor when the battery is too low
- LED display of the service interval and any error messages

Pressing

Press machine compact

ROMAX Compact TT (TWIN TURBO)

Electro-hydraulic press machine for battery operated pressing of fittings up to Ø 40 mm (plastic / multi-layer) and / or up to Ø 35 mm (metal) with 19 kN.



Product profile

APPLICATION AREA

The ROMAX Compact TT is 3 seconds fast, 2.5 kg light and 19 kN strong. Through the perfect handling, the machine is particularly suitable for domestic installations, high volume pressings or service installations.

COMPATIBLE PRESSING TOOLS

- Press jaws: ROTHENBERGER press jaws compact starting on page 111
- Interchangeable press jaws: ROTHENBERGER interchangeable press jaws starting on page 112

TECHNICAL DATA

Dimension:	336 x 143 x 76 mm (w/ 2.0 Ah battery)
Weight:	Approx. 2.5 kg (without press jaw)
Piston force / hub:	19 kN / 30 mm
Nominal size:	Ø 12 - 40 mm plastic / multi-layer Ø 12 - 35 mm metal
Service interval:	40,000 pressings / 2 years
Press jaw fixture:	270° rotation
Power supply:	RO BP 18 V / 2.0 Ah Li-Ion battery RO BP 18 V / 4.0 Ah Li-Ion battery
Operating temperature:	-10 °C up to 60 °C
Pressings:	Approx. 130 press cycles with 2.0 Ah battery tested with SV18 stainless steel fittings

5



When unused or during preassembly, the machine stands stably on the workbench.



The ROMAX Compact TT hanging from a ladder by the shoulder strap.



Secondary effect of the two cylinder-structure: The machine can be used with one hand.



ROMAX Compact TT sets



Twin Turbo: What's behind it?

BALANCE

- The engine and the gear are located opposite the hydraulic system
- Perfectly balanced weight distribution

SIZE

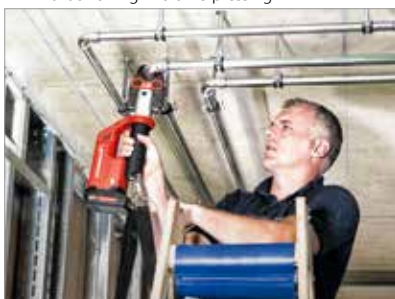
- Installing components in two cylinders reduces the size of the machine
- The two-cylinder shape saves 15% of the length

POWER

- Every press cycle takes only 3 seconds
- The new pressure heart enables pressing of metal fittings up to Ø 35 mm

5

Twin Turbo for high volume pressing



Twin Turbo for domestic installations



Twin Turbo for service installations



Basic set 1 EU (No. 1000002115) includes: ROMAX Compact TT press machine, 1x RO BP 18 V / 2.0 Ah Li-ion battery (No. 1000001652), RO BC battery charger EU (No. 1000001654), ROCASE case system 4414, without press jaws

Model	Press jaws Ø mm	kg	No.
ROMAX Compact TT bare tool	without press jaws/battery/charger	4.2	1000002809
ROMAX Compact TT basic set 1, 1x 2.0 Ah, EU	without press jaws	4.9	1000002115
ROMAX Compact TT basic set 1, 1x 2.0 Ah, UK	without press jaws	4.9	1000002123
ROMAX Compact TT basic set 2, 2x 2.0 Ah, EU	without press jaws	5.3	1000002116
ROMAX Compact TT press jaw set SV, 1x 2.0 Ah, EU	15 - 22 - 28	8.6	1000002117
ROMAX Compact TT press jaw set M, 1x 2.0 Ah, EU	15 - 22 - 28	8.6	1000002118
ROMAX Compact TT press jaw set M, 1x 2.0 Ah, UK	15 - 22 - 28	8.6	1000002124
ROMAX Compact TT press jaw set TH, 1x 2.0 Ah, EU	16 - 20 - 26	8.8	1000002120
ROMAX Compact TT press jaw set U, 1x 2.0 Ah, EU	16 - 20 - 25	8.6	1000002119
ROMAX Compact TT interchangeable press jaw set TH, 1x 2.0 Ah, EU	16 - 20 - 26 - 32	6.9	1000002113
ROMAX Compact TT interchangeable press jaw set U, 1x 2.0 Ah, EU	16 - 20 - 25 - 32	6.9	1000002112
ROMAX Compact TT interchangeable press jaw set RFz, 1x 2.0 Ah, EU	16 - 20 - 25 - 32	6.9	1000002111
ROMAX Compact TT interchangeable press jaw set CO, 1x 2.0 Ah, EU	12 - 16 - 20 - 25	6.9	1000002114

ACCESSORIES

Model	No.
RO BP 18V / 2.0 Ah Li-ion battery	1000001652
RO BP 18V / 4.0 Ah Li-ion battery	1000001653
RO BP 18V / 4.0 Ah Li-HD battery	1000002548
RO BP 18V / 8.0 Ah Li-HD battery	1000002549
RO BC 14/36, battery charger, EU	1000001654
RO BC 14/36, battery charger, UK	1000001691
ROCASE 4414 for press jaws	1000002242
ROCASE 4414 for interchangeable inserts	1000002307

Press jaws & interchangeable press jaws starting on 112



Pressing

Conex Bänninger ›B‹ MaxiPro press system

Join the press revolution!

An innovative press system suitable for air-conditioning and refrigeration applications consisting of Conex Bänninger ›B‹ MaxiPro fittings, suitable press jaws and press machines from ROTHENBERGER.



Product profile

TIGHT CONNECTIONS UP TO 48 BAR

- The O-ring is resistant against several oils including ester oil.*
- The 3-point press, one on each side of the bead and one press compressing the O-ring, provides a permanent and secure joint.

THE ADVANTAGES

- Only 3 seconds per joint completion
- Saves approx. 3 minutes per connection
- Flame-free joint, no hot work permit needed
- No need for nitrogen purge

MADE-TO-LAST THROUGH LASER HARDENING

The press jaws are partially laser-hardened. This makes them particularly durable in those places that take the most pressure. Laser hardening increases the jaws' durability considerably.



Press jaw for ROMAX Compact TT
No. 1000001751

Press jaw for ROMAX 4000
No. 1000001891

Standard press ring set
No. 1000003532



Set (No. 1000002121) includes: ROMAX Compact TT press machine, 1x RO BP 18 V/2.0Ah battery (No. 1000001652), RO BC battery charger EU (No. 1000001654), 8x press jaws (No. see below), TC 35 (No. 70027), internal/external deburrer (No. 150000237), UNIGRAT pencil deburrer (No. 21660), ROVLIES cleaning pads (No. 45268), depth gauge (No. 1000002400), 2x RO CASE 4414 case system

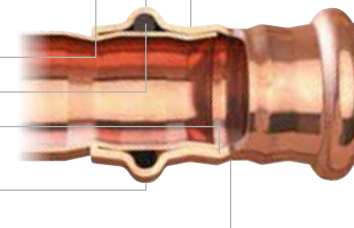
TECHNICAL DATA

Application:	Air-conditioning and refrigeration
Connections:	Copper to copper
Fitting / tube range:	1/4", 3/8", 1/2", 5/8", 3/4", 7/8", 1", 1.1/8"
O-ring:	HNBR
Max. operating pressure:	48 bar/4,800 kPa/700 psig
Leak tightness:	Helium $\leq 7.5 \times 10^{-7}$ Pa.m ³ /s at +20°C, 10 bar
Vacuum:	200 microns
Operating temperature:	-40°C up to 140°C
UL listing continues operating temperature:	121°C
Compatible refrigerants:	R32, R134a, R404A, R407C, R407F, R410A, R507, R1234ze, R1234yf, R718, R450A, R513A, R448A, R449A, R407A, R427A, R438A, R417A and R422D
Approved tube:	For full information, please visit conexbanninger.com
Approvals, standards and test compliance:	For full information, please visit conexbanninger.com

3-POINT PRESS TECHNOLOGY

Three press points: one on each side of the bead and one compressing the O-ring for a permanent and secure joint

- Hock
- HNBR O-ring
- Fitting socket
- Bead
- Tube stop



Model	Press jaws Ø inch	kg	No.
ROMAX Compact TT + press jaw compact set 1/4"-1.1/8" + hand tools, EU	1/4", 3/8", 1/2", 3/4", 5/8", 7/8", 1", 1.1/8"	21.2	1000002121
ROMAX Compact TT + press jaw compact set 1/4"-1.1/8" + hand tools, UK	1/4", 3/8", 1/2", 3/4", 5/8", 7/8", 1", 1.1/8"	21.2	1000002125
Press jaw compact set 1/4"-1.1/8" + hand tools	1/4", 3/8", 1/2", 3/4", 5/8", 7/8", 1", 1.1/8"	14.0	1000001989
ROMAX 4000 + press jaw standard set 1/4"-1.1/8" + hand tools, EU	1/4", 3/8", 1/2", 3/4", 5/8", 7/8", 1", 1.1/8"	24.3	1000002945
ROMAX 4000 + press jaw standard set 1/4"-1.1/8" + hand tools, UK	1/4", 3/8", 1/2", 3/4", 5/8", 7/8", 1", 1.1/8"	24.3	1000002946
Press jaw standard set 1/4"-1.1/8" + hand tools	1/4", 3/8", 1/2", 3/4", 5/8", 7/8", 1", 1.1/8"	18.1	1000002207
Standard press ring set	1/4 - 1.1/8"	6.3	1000003532
Compact press ring set	1/4 - 1.1/8"	5.3	1000003536
Standard press ring set	1/4 - 5/8"	4.8	1000003625
Compact Press ring set	1/4 - 5/8"	5.3	1000003624

Conex Bänninger ›B‹ MaxiPro press system

How to install the Conex Bänninger ›B‹ MaxiPro system?

Conex Bänninger ›B‹ MaxiPro benefits from a 3-point radial press – three press points, one on each side of the bead and one press compressing the O-ring. This provides a permanent and secure joint. As the connection is a mechanical joint, there is no need for nitrogen purge during the joining process.

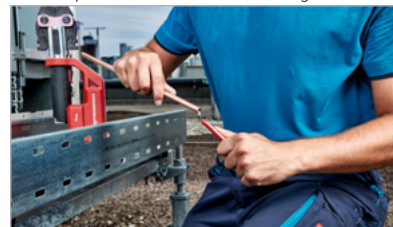
1. Cut the tube to length.



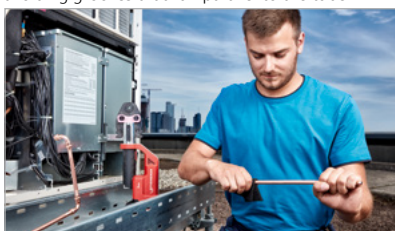
2. Deburr and remove all external sharp edges.



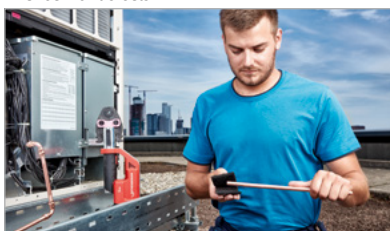
3. Use a pencil deburrer on internal edges.



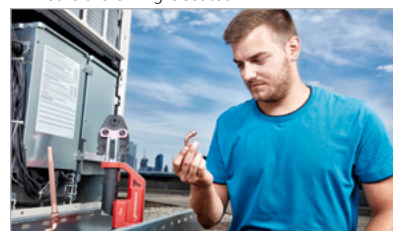
4. Clean the tube end with a circular movement, avoiding grooves that run parallel to the tube.



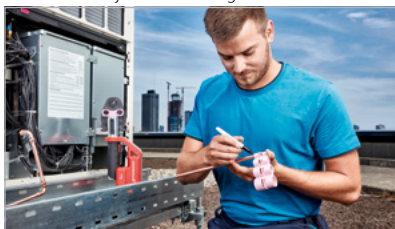
5. Check for defects.



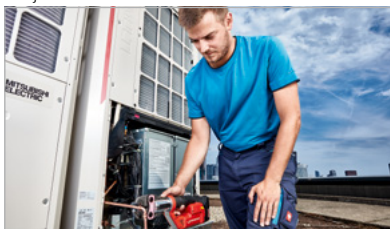
6. Ensure the O-ring is seated.



7. Mark insertion depth using depth gauge and insert tube fully into the fitting.



8. Align jaws squarely on the fitting and complete the joint.




9. Mark the completed joint.



Please note: To ensure a safe and tight connection please follow the detailed Conex Bänninger ›B‹ MaxiPro installation process. For more information, please visit the Conex Bänninger website: conexbanninger.com

The ›B‹ MaxiPro® system is an innovative press system by Conex Bänninger®. ›B‹ MaxiPro® and Conex Bänninger® are registered trademarks of Conex IPR Limited.

ACCESSORIES

Model		No.
RO BP 18V / 2.0 Ah Li-Ion battery		100001652
RO BP 18V / 4.0 Ah Li-Ion battery		100001653
RO BP 18V / 4.0 Ah Li-HD battery		100002548
RO BP 18V / 8.0 Ah Li-HD battery		100002549
RO BC 14/36, battery charger, EU		100001654
RO BC 14/36, battery charger, UK		100001691
ROCASE 4414 case system		100001786
for compact press jaws		
ROCASE 4414 case system		100001898
for standard press jaws		
TUBE CUTTER 35 DURAMAG	4	70027
Internal / external deburrer Ø 6–35 mm		150000237
UNIGRAT pencil deburrer	10	21660
with HSS deburring blade		
ROVLIES cleaning pads (1 x 10 pads)		45268
Conex Bänninger ›B‹ MaxiPro depth gauge		100002400



Pressing

Press machines standard

ROMAX 4000

Electro-hydraulic radial battery-powered press machine for system depending pressing of fittings up to Ø 110 mm with 32 - 34 kN.



Product profile

APPLICATION AREA

The ROMAX 4000 operates in just 5 seconds, weighs only 3.6 kg and uses a force of 32 kN. It can press from 12 mm to 110 mm depending on the system and is therefore the perfect all-rounder amongst the ROTHENBERGER press machines.

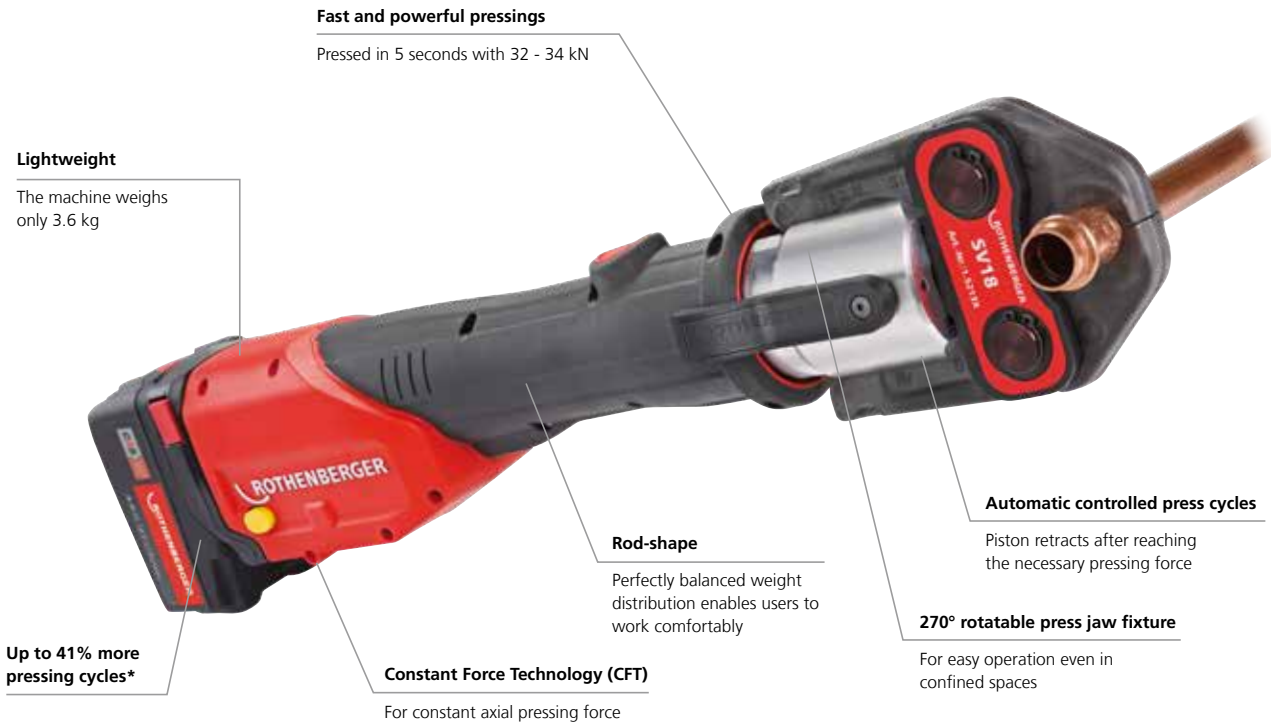
COMPATIBLE PRESSING TOOLS

- Press jaws: ROTHENBERGER press jaws standard starting on page 112 and 3-elemental standard press jaws starting on page 113
- Press chains: ROTHENBERGER press chains standard starting on page 114

TECHNICAL DATA

Dimensions:	467 x 125 x 80 mm (w/ 4.0 Ah battery) 445 x 125 x 75 mm (w/ 2.0 Ah battery)
Weight:	Approx. 3.6 kg (without press jaw)
Piston force / hub:	32 - 34 kN / 40 mm
Nominal size:	Ø 12 - 110 mm
Service interval:	40,000 pressings / 2 years
Press jaw fixture:	270° rotation
Power supply:	RO BP 18 V / 2.0 Ah Li-ion battery RO BP 18 V / 4.0 Ah Li-ion battery
Operating temperature:	-10 °C up to 60 °C
Pressings:	Up to 240 times (with 4.0 Ah battery) (with SV 18 copper) Up to 105 times (with 2.0 Ah battery)

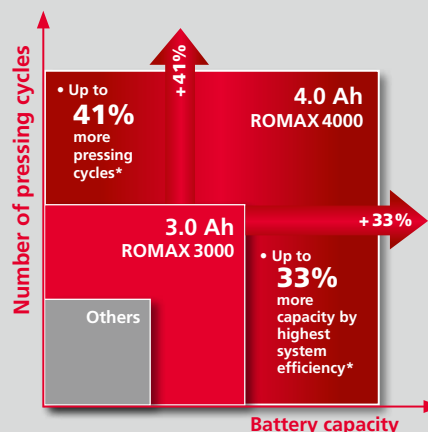
5



Enter a new dimension of efficiency!

- Powerful 18 V / 4.0 Ah battery pack
- Up to 41% more pressing cycles*
- Up to 33% more capacity due to enhanced system efficiency*
- All this without a cord-maximum efficiency and on-site freedom for you!

* Tested with SV 18 copper fittings / in comparison with ROMAX 3000



ROMAX 4000 sets



66% faster charging

In comparison to the ROMAX 3000



Intelligent battery-management

One battery. Several devices.
Full flexibility!



Charge indicator

To control the status of charge

5

Ergonomic working with the ROMAX 4000



Productive working due to expanded service interval



Cordless Alliance System:
One battery system for more than 140 tools



Basic set 1 EU (No. 1000001840) includes: ROMAX 4000 Press machine, 1x RO BP 18 V / 4.0 Ah battery (No. 1000001653), RO BC battery charger EU (No. 1000001654), ROCASE case system 6414, without press jaws

Model	Press jaws Ø mm	kg	No.
ROMAX 4000 bare tool	without press jaws/battery/charger	5.9	1000002683
ROMAX 4000 basic set 1, 1x 4.0 Ah, EU	without press jaws	7.0	1000001840
ROMAX 4000 basic set 1, 1x 4.0 Ah, UK	without press jaws	7.0	1000001856
ROMAX 4000 basic set 2, 1x 4.0 Ah, 1x 2.0 Ah, EU	without press jaws	8.0	1000001923
ROMAX 4000 press jaw set SV, 1x 4.0 Ah, EU	15 - 22 - 28	15.0	1000001924
ROMAX 4000 press jaw set M, 1x 4.0 Ah, EU	15 - 22 - 28	15.0	1000001927
ROMAX 4000 press jaw set M, 1x 4.0 Ah, UK	15 - 22 - 28	15.0	1000001932
ROMAX 4000 press jaw set TH, 1x 4.0 Ah, EU	16 - 20 - 26	15.0	1000001925
ROMAX 4000 press jaw set U, 1x 4.0 Ah, EU	16 - 20 - 25	15.0	1000001926

ACCESSORIES

Model	No.
RO BP 18V / 2.0 Ah Li-Ion battery	1000001652
RO BP 18V / 4.0 Ah Li-Ion battery	1000001653
RO BP 18V / 4.0 Ah Li-HD battery	1000002548
RO BP 18V / 8.0 Ah Li-HD battery	1000002549
RO BC14/36, battery charger, EU	1000001654
RO BC14/36, battery charger, UK	1000001691
ROCASE 6414, empty	1000001879

Press jaws & press chains starting on 116



Pressing

Press machines standard

ROMAX 3000 AC

Electro-hydraulic press machine with mains operation for system dependent pressing of fittings up to Ø 110 mm with 32 - 34 kN.



Product profile

APPLICATION AREA

The ROMAX 3000 AC is fast, light, easy to handle and safe. It is therefore ideally suited for the batch production of fitting joints in field operation.

- Batch production possible due to mains operation (5 m cable length)
- A pressing cycle only lasts approx. 5 seconds
- Constant Force Technology (CFT) guarantees the necessary pressing force
- Extremely low weight as well as a balanced weight distribution
- Highest quality, service interval of 20,000 pressing cycles
- Expanded operating temperature from -15 °C up to 60 °C
- The compact, wand-like design allows pressings even in confined spaces

TECHNICAL DATA

Dimensions:	460 x 120 x 90 mm
Weight:	approx. 3.8 kg (without press jaw)
Piston force / hub:	32 kN / 40 mm
Nominal size:	Ø 12 - 110 mm ²⁾
Service interval:	20,000 pressings / 2 years
Press jaw fixture:	270° rotation
Power supply:	230 V / 50-60 Hz 110 V on request
Operating temperature:	-15 °C up to 60 °C

COMPATIBLE PRESSING TOOLS

Press jaws:	ROTHENBERGER standard press jaws, compatible with many other manufacturers starting page 112
Press chains:	ROTHENBERGER standard press chains starting on page 114

5

Safety lock

No unintentional opening because a 180° rotation is necessary

Balanced weight distribution

Ergonomic use



Compatible jaw fixture

Suitable for many press jaws

270° rotatable jaw fixture

For easy use in confined spaces

Batch production possible



Slim design



5 m cable length

Large operations radius

Set (No. 100001001) includes: ROMAX 3000 AC, 230 Volt, ROCASE 6414, without press jaws

Model No.

ROMAX 3000 AC basic set **100001001**

ACCESSORIES



Model No.

ROCASE 6414 with inlay ROMAX 3000 AC **100001877**

Press jaws & press chains starting on 116

ROMAX AC ECO

Electro-hydraulic press machine with mains operation for system dependent pressing of fittings up to Ø 110 mm with 32 - 34 kN.



Product Profile

APPLICATION AREA

The ROMAX AC ECO is fast, light, easy to handle and safe. It is therefore ideally suited for the batch production of fitting joints in field operation.

KEY FEATURES

- Ergonomic thanks to the rubberized handle and balanced weight distribution
- Controlled press cycle
- Constant Force Technology (CFT) guarantees the necessary pressing force
- Safety lock guarantees no unintentional opening because a 180° rotation is necessary
- Emergency stop switch for immediate interruption of the feed
- 5 m cable for a large operations radius

TECHNICAL DATA

Dimensions:	415 x 180 x 80 mm
Weight:	approx. 4.5 kg (without press jaw)
Piston force / hub:	32 kN / 40 mm
Nominal size:	Ø 12 - 110 mm ²⁾
Service interval:	10,000 pressings / 2 years
Press jaw fixture:	270° rotation
Power supply:	230 V / 50-60 Hz 110 V on request

COMPATIBLE PRESSING TOOLS

Press jaws:	ROTHENBERGER standard press jaws, compatible with many other manufacturers starting on page 112
Press chains:	ROTHENBERGER standard press chains starting on page 114

270° rotatable jaw fixture

For easy use in confined spaces

Safety lock

No unintentional opening because a 180° rotation is necessary

Compatible jaw fixture

Suitable for many press jaws

Emergency stop switch

Immediate interruption of the feed

Balanced weight distribution

Ergonomic use

5 m cable length

Large operations radius

Constant Force Technology (CFT)

For constant axial pressing force



Fig. ROMAX AC ECO basic set

Set (No. 15705) includes: ROMAX AC ECO (230 Volt) ROCASE 6414 (No. 100001959), without press jaws

Model	Description	Press jaws Ø mm	kg	No.
ROMAX AC ECO basic set	in ROCASE 6414	without press jaws	8.9	15705
ROMAX AC ECO press jaw set SV	Basic set with press jaws type SV (Viega et al.)	15 - 22 - 28	13.4	15740
ROMAX AC ECO press jaw set M	Basic set with press jaws type M (Mapress et al.)	15 - 22 - 28	13.4	15750
ROMAX AC ECO press jaw set TH	Basic set with press jaws type TH (Henco et al.)	16 - 20 - 26	13.4	15730
ROMAX AC ECO press jaw set U	Basic set with press jaws type U (UNICOR et al.)	16 - 20 - 25	13.4	15760

ACCESSORIES

Model	No.
ROCASE 6414 with inlay ROMAX AC ECO	100001959
Press jaws & press chains starting on 116	



¹⁾ Complete terms and conditions at rothenberger.com/roservice
RO SERVICE+ only valid in participating countries

²⁾ system dependent

Pressing

DURA LAZR TEC

DURA LAZR TEC

The unique laser-hardening process

Long-lasting. Safe. Precise. Our DURA LAZR TEC press jaws set is a new industry standard. The unique ROTHENBERGER laser-hardening process, which is implemented in our own production, provides maximum stability and wear resistance. And, therefore, more safety and a longer service life!

Depth distribution of hardness was tested by the independent test laboratory of the State Materials Testing Institute Darmstadt (MPA).



Partial laser-hardening for highly stressed surfaces

- Ideal accuracy of contour for highest precision during the complete live time
- 40% increase in hardness*

Highest degree of hardness

- ROTHENBERGER press jaws are performing with the highest degree of hardness at high stressed areas
- Even in the case of high burr formation during compression, the wear is reduced to a minimum



5



100% extended lifetime of the press jaws among other things due to laser hardening*

Parts which have to be flexible stay ductile

Adjustment of the plate

Durability increased by approx. 45%*

**+ 40 %
HARDNESS
AT HIGHLY STRESSED
AREAS ***

**+100%
PRESS CYCLES
WITH LASER
HARDENING***

**ROTHENBERGER press jaws
before surface treatment**

Press jaws compact

For ROMAX Compact TT

ROTHENBERGER press jaws with proven material and manufacturing quality for system dependent pressing of fittings up to Ø 40 mm (plastic / multi-layer) and/or up to Ø 28 mm (metal).



DURA LAZR TEC

100% more press cycles with laser hardening*

3-bolt synchronised mechanism

- Highest precision when pressing
- Synchronised run of the jaw lever
- Increased stability and durability
- Open the jaw with just 1 finger!

Batch numbering and individual testing

Secures the high-quality standard of material and press contour

Product identification, simple to read, clear system and nominal size classification



Precision-manufactured contours

For optimum and reliable pressings

Made of forged, highly resilient special steel

Suitable for all press machines with a constant axial thrust of 19–21 kN and compatible press jaw fixture

Permanent bolt

- Without potential weak points / no thread
- Considerable reduction of the breakage risk
- Increased safety

Long-term corrosion protection

Optimum for heavy-duty field operation

Optimised inlet contour

- Adapted power flow
- Less wear and tear



Press jaws compact Ø 35 mm

For ROMAX Compact TT

ROTHENBERGER compact press jaws SV35 and M35 with optimized material and manufacturing quality, suitable for system conforming pressing of metal fittings of Ø 35 mm with the ROMAX Compact TT pressing machine.



DURA LAZR TEC

100% more press cycles with laser hardening*

3-bolt synchronised mechanism

- Highest precision when pressing
- Synchronised run of the jaw lever
- Increased stability and durability
- Open the jaw with just 1 finger!

Product identification, simple to read, clear system and nominal size classification



Precision-manufactured contours

For optimum and reliable pressings

Made of forged, highly resilient special steel

Suitable for all press machines with a constant axial thrust of 19–21 kN and compatible press jaw fixture

Permanent bolt

- Without potential weak points / no thread
- Considerable reduction of the breakage risk
- Increased safety

Long-term corrosion protection

Optimum for heavy-duty field operation



Optimised inlet contour

- Adapted power flow
- Less wear and tear

Model	kg	No.
Press jaw compact, SV35	2.2	1000002266
Press jaw compact, M35	2.2	1000002267

ACCESSORIES

Model	No.
ROCASE 4212 with inlay compact press jaws	1000002655
Press jaw overview starting on 117	



* in comparison to previous models

Pressing

Press jaws compact / standard

Interchangeable press jaw compact

For ROMAX Compact TT

ROTHENBERGER interchangeable press jaw for system dependent pressing of plastic fittings Ø 12 - 32 mm.

Combine various interchangeable inserts with only one press jaw!



Interchangeable inserts set

3-bolt synchronised mechanism

Synchronised run of the jaw lever enables the jaw to be opened with just one finger

Batch numbering and individual testing

Secures the high-quality standard of material and press contour



Guiding ridge

Safe admittance from interchangeable press jaws

Made of forged, highly resilient special steel

Suitable for all press machines with a constant axial thrust of 19–21 kN and compatible press jaw fixture

Long-term corrosion protection

Optimum for heavy-duty field operation

Model	Inserts Ø mm	No.	Model	Inserts Ø mm	No.
Interchangeable inserts compact set, RFz ¹⁾	16, 20, 25, 32	14849	Interchangeable press jaw compact	w/o inserts	1000002134
Interchangeable inserts compact set, U ¹⁾	16, 20, 25, 32	14869	Interchangeable press jaw + set, RFz	12, 16, 20	1000002135
Interchangeable inserts compact set, TH ¹⁾	16, 20, 26, 32	14895	Interchangeable press jaw + set, CO	12, 16, 20	1000002136

¹⁾ Can only be used with interchangeable press jaw No. 1000002134 (successor of No. 014880X)!

Press jaws standard

For ROMAX 4000, ROMAX 3000 AC and ROMAX AC ECO

ROTHENBERGER press jaws with proven material and manufacturing quality, for system conforming pressing of fittings up to Ø 40 mm (plastic / multi-layer) and/or up to Ø 54 mm (metal).

DURA LAZR TEC

100% more press cycles with laser hardening*

3-bolt synchronised mechanism

- Highest precision when pressing
- Synchronised run of the jaw lever
- Increased stability and durability
- Open the jaw with just one finger!

Batch numbering and individual testing

Secures the high quality standard of material and press contour

Product identification, simple to read, clear system and nominal size classification



Precision-manufactured contours

For optimum and reliable pressings



Made of forged, highly resilient special steel

Suitable for all press machines with a constant axial thrust of 32–34 kN and compatible press jaw fixture

Permanent bolt

- Without potential weak points / no thread
- Considerable reduction of the breakage risk
- Increased safety

Long-term corrosion protection

Optimum for heavy-duty field operation

Optimised inlet contour

- Adapted power flow
- Less wear and tear



Press jaw overview starting on 117

Press jaws standard 3-elemental

For ROMAX 4000, ROMAX 3000 AC and ROMAX AC ECO

ROTHENBERGER 3-elemental press jaws with proven material and manufacturing quality, for system dependent pressing of M42/M54 fittings and TH50/TH63 fittings.

Made of forged, highly resilient special steel

Suitable for all press machines with a constant axial thrust of 32–34 kN and compatible press jaw fixture

Precision-manufactured contours

For optimum and reliable pressings

Wide jaw mouth for easy assembling of the jaw on the fitting



DURA LAZR TEC

100% more press cycles with laser hardening*

3-bolt synchronised mechanism

- Highest precision when pressing
- Synchronised run of the jaw lever
- Increased stability and durability
- Open the jaw with just 1 finger!

3-elemental system

- Easy handling / assembling
- Optimized power distribution



Model	kg	No.	Model	kg	No.
Press jaws standard 3-elemental, M42	4.8	1000001273	Press jaws standard 3-elemental, TH50	4.8	1000001810
Press jaws standard 3-elemental, M54	4.8	1000001274	Press jaws standard 3-elemental, TH63	4.8	1000001811

Press jaws standard sets

ROTHENBERGER press jaws up to Ø 54 mm in the stable ROCASE case system



Effective

Enough space for up to 7 press jaws in the ROCASE 4414 up to Ø 63 mm

Effective

Enough space for up to 4 press jaws in the ROCASE 4212 up to Ø 32 mm

Variable

Enough space for all standard and compact press jaws in the ROCASE 4414 up to Ø 63 mm



ROCASE case system

Stack, click, transport

Model	Press jaws Ø mm	kg	No.
Press jaw standard set, SV	15 - 22 - 28	6.8	1000002068
Press jaw standard set, SV	15 - 18 - 22 - 28	8.7	015060X
Press jaw standard set, SV	42 - 54	10.5	015080X
Press jaw standard set, M	15 - 22 - 28	6.7	1000002067
Press jaw standard set, M	15 - 18 - 22 - 28	8.6	015062X
Press jaw standard set 3-elemental, M	42 - 54	12.0	1000001502
Press jaw standard set, TH	16 - 20 - 26	8.7	015063X
Press jaw standard set, U	16 - 20 - 25	7.3	1000002069
Press jaw standard set, G	16 - 20 - 26 - 32	8.8	015068X
Press jaw standard set, BE	16 - 20 - 26	8.7	1000002065
ROCASE 4414 with inlay up to 7 press jaws		1.5	1000001807
ROCASE 4212 with inlay up to 4 press jaws		1.6	1000001808

ROCASE starting on 335

Pressing

Press chains standard

Press chains standard

For ROMAX 4000, ROMAX 3000 AC and ROMAX AC ECO

Suitable for press machines with a constant, axial pressing force of 32 - 34 kN and the appropriate compatible press jaw fixture. For the system conforming pressing of fittings from Ø 42 mm up to Ø 54 mm (metal) and/or from Ø 40 mm up to Ø 110 mm (multi-layer).



DURA LAZR TEC

100% more press cycles with laser hardening*

Batch numbering and individual testing

Secures the high-quality standard of material and press contour

Long-term corrosion protection

Optimum for heavy-duty field operation



Fig. press chain SV54



Fig. intermediate jaw ZBS1

Precision-manufactured contours

For optimum and reliable pressings

Clamping technology

Self-clamping press chain

3 segments

- For an optimum force distribution on the fitting
- Two flexible elements for an optimal material flow on the fitting

Low weight

Comfortable operation even over long periods of work

Made of forged, highly resilient special steel

Suitable for all press machines with a constant, axial force of 32 - 34 kN and compatible press jaw fixture

3-bolt synchronised mechanism

Synchronised run of the jaw lever enables the jaw to be opened with just one finger

Opening of the press chain up to 180° allows assembling even in confined spaces




Closing the press chain













Gripping the press chain with intermediate jaws



Press chain sets include: Press chains according to the table, intermediate jaw ZBS1 (No.1000001126), ROCASE case system 4212 (No.1000001960)

Model	Press chains Ø mm		No.
Press chain set, SV with intermediate jaw ZBS1	42-54	7.3	1000001501
Press chain set, M with intermediate jaw ZBS1	42-54	7.3	1000001500
Intermediate press jaw ZBS1	For press chains SV, M and U up to Ø 54 mm	2.1	1000001126
Press chain standard, M	42 for ZBS1	1.3	1000001391
Press chain standard, M	54 for ZBS1	1.5	1000001392
Press chain standard, SV	42 for ZBS1	1.3	1000001393
Press chain standard, SV	54 for ZBS1	1.5	1000001394











Overview press jaws

System	Nominal size	 Press jaws compact	 Interchangeable insert compact Use only in combination with interchangeable jaws (No. 1000002134)	 Press jaws standard	 Press chains standard Only to be used with intermediate jaw ZBS1 (No. 1000001126) for SV, M, Ø 42–54 mm
A	Metal / NE-Metal				
	A1/2"	—	—	015222X	—
	A3/4"	—	—	015223X	—
	A1"	—	—	015224X	—
	A1 1/4"	—	—	015225X	—
	A1 1/2"	—	—	015226X	—
	A2"	—	—	015227X	—
M	M12	015151X	—	015101X	—
	M15	015152X	—	015102X	—
	M18	015153X	—	015103X	—
	M22	015154X	—	015104X	—
	M28	015155X	—	015105X	—
	M35	1000002267	—	015106X	—
	M42	—	—	1000001273	1000001391
	M54	—	—	1000001274	1000001392
	V/SV	V/SV12	015261X	—	015211X
	V/SV14	015269X	—	015219X	—
	V/SV15	015262X	—	015212X	—
	V/SV16	015260X	—	015220X	—
	V/SV18	015263X	—	015213X	—
	V/SV22	015264X	—	015214X	—
	V/SV28	015265X	—	015215X	—
	V/SV35	1000002266	—	015216X	—
	V/SV42	—	—	015217X	1000001393
	V/SV54	—	—	015218X	1000001394
	R(H)	PEX / Multilayer			
	R12	—	14863	015339X	—
	R14	015370X	—	015330X	—
	R16	015371X	14865	015331X	—
	R17	015378X	—	015333X	—
	R18	015379X	—	015334X	—
	R20	015374X	14868	015335X	—
	R25	015380X	—	015338X	—
	R26	015376X	14708	015336X	—
	R32	015377X	—	015337X	—
RFz	RFz12	—	14822	1000000173	—
	RFz16	015180X	14823	015161X	—
	RFz18	—	1000000124	—	—
	RFz20	015181X	14824	015162X	—
	RFz25	015182X	14825	015163X	—
	RFz26	—	1000000125	—	—
	RFz32	015183X	14826	015164X	—
TH	TH14	015395X	14708	015321X	—
	TH16	015385X	14843	015322X	—
	TH18	015398X	14844	015323X	—
	TH20	015389X	14845	015324X	—
	TH25	015399X	14846	015325X	—
	TH26	015391X	14847	015326X	—
	TH32	015393X	14848	015327X	—
	TH40	015401X	—	015328X	—
	TH50	—	—	1000001810	—
	TH63	—	—	1000001811	—
	THG	THG32	1000000236	—	1000000235
THT	THT32	015393H	—	015329X	—

For more information visit rothenberger.com

Pressing

Overview press jaws / Pressnavigator app

System	Nominal size	 Press jaws compact	 Interchangeable insert compact Use only in combination with interchangeable jaws (No. 1000002134)	 Press jaws standard	 Press chains standard Only to be used with intermediate jaw ZB51 (No. 1000001126) for SV, M, TH Ø 40, 42, 50, 63 mm
U			PEX / Multi-layer		
	U14	015351X	14832	015311X	—
	U16	015352X	14833	015312X	—
	U18	015353X	14834	015313X	—
	U20	015354X	14835	015314X	—
	U25	015355X	14836	015315X	—
	U32	015357X	14838	015317X	—
	U40	015358X	—	015318X	—
	U50	—	—	—	—
	U63	—	—	—	—
	U75	—	—	—	—
	U90	—	—	—	—
U110	—	—	—	—	
RC	RC26	015277X	14837	015271X	—
VP 	VP14	015530X	14882	015230X	—
	VP16	015531X	14883	015231X	—
	VP20	015532X	14884	015232X	—
	VP25	015533X	14885	015233X	—
	VP32	015534X	14886	015234X	—
BE 	BE16	015291X	—	015392X	—
	BE20	015292X	—	015394X	—
	BE26	015293X	—	015396X	—
	BE32	015294X	—	015397X	—
CO 	CO12	—	14852	—	—
	CO16	—	14853	—	—
	CO20	—	14854	—	—
	CO25	—	14855	—	—
G 	G16	015362X	—	015302X	—
	G20	015364X	—	015304X	—
	G26	015366X	—	015306X	—
	G32	015367X	—	015307X	—
	G40	015368X	—	015308X	—
HA 	HA16	015580X	—	015280X	—
	HA20	015581X	—	015281X	—
	HA26	015582X	—	015282X	—
	HA32	015583X	—	015283X	—
	HA40	—	—	015284X	—

For more information visit rothenberger.com

Pressnavigator app

Pressnavigator for easy verification of the compatibility of press tool and fitting system

Which press tool is suitable for which fitting system? The ROTHENBERGER Pressnavigator offers convenient assistance: with just a few clicks, the compatibility between our press tools and the established fitting system can be checked. The app is available in German or English.



App for smartphone & tablet
FOR EASY VERIFICATION OF THE COMPATABILITY OF PRESS TOOLS
AVAILABLE FOR iOS & Android!



iTunes



Google Play







Threading & grooving

System overview	126 - 127
Threading manual	128 - 131
Threading electric	132 - 144
Accessories threading	145
Roll grooving	146 - 147



Threading & grooving

System overview

Threader manual





	SUPER CUT sets 1/2 - 1.1/4"	SUPER CUT sets 3/8 - 1.1/4"	SUPER CUT sets 3/8 - 2"	SANI KIT 1/2 - 1"
				
Operation mode:	Handed / manual	Handed / manual	Handed / manual	Handed / manual
Working range:	1/2 - 1.1/4"	3/8 - 1.1/4"	3/8 - 2"	1/2 - 1"
Handle:	1 pc.	2 pcs.	3 pcs.	2 pcs.
Thread type:	BSPT - NPT	BSPT - NPT	BSPT - NPT	BSPT - NPT
Number of die heads:	4 pcs.	Up to 5 pcs.	Up to 7 pcs.	3 pcs.
Number of threading dies:	–	–	–	–
Power:	–	–	–	–
Weight:	5.1 kg	6.2 kg	11.4 kg	8.2 kg
Page	128 - 129	128 - 129	128 - 129	130 - 131

Threader electric

	SUPERTRONIC 1250	SUPERTRONIC 2000	SUPERTRONIC 2000 E
			
			
Operation mode:	Handed / electric	Handed / electric	Handed / cordless
Working range:	1/2 - 1.1/4"	1/2 - 2"	1/2 - 2"
Thread type:	BSPT - NPT	BSPT - NPT	BSPT - NPT
Number of die heads:	4 pcs.	6 pcs.	6 pcs.
Number of threading dies:	–	–	–
Power:	800 W	1,010 W	18 V
Total weight:	12.8 kg	14.5 kg	16 kg
Page	132 - 133	134 - 135	136 - 137

6

Threader stationary

	ROPOWER 50 R	SUPERTRONIC 2 SE	SUPERTRONIC 3 SE	SUPERTRONIC 4 SE
				
Operation mode:	Stationary	Stationary	Stationary	Stationary
Working range:	1/2 - 2"	1/2 - 2"	1/2 - 3"	1/2 - 4"
Thread type:	BSPT, NPT, BSPP, BSW, metric	BSPT, NPT, BSPP, BSW, metric	BSPT, NPT, BSPP, BSW, metric	BSPT, NPT, BSPP, BSW, metric
Number of die heads:	1 pc.	1 pc.	2 pcs.	2 pcs.
Number of threading dies:	2 pcs.	2 pcs.	3 pcs.	3 pcs.
Power:	1,150 W	1,150 W	1,700 W	1,750 W
Weight:	88.5 kg	68.5 kg	100 kg	120 kg
Page	140 - 141	142 - 143	142 - 143	142 - 143

6

Roll grooving machines

	Hand roll groover 1-12"	ROGROOVER 1-6"	ROGROOVER 1-12"
			
Operation mode:	Handed-manual / handed-electric	Handed-electric / stationary	Stationary
Working range:	1 - 12"	1 - 6"	1 - 12"
Drive unit:	SUPERTRONIC 1250 / 2000	SUPERTRONIC 2000 / 2 - 4SE	Motor
Wall thickness:	Up to 10 mm	Up to 10 mm	Up to 10 mm
Pressure rollers included:	1 pc.	1 pc.	3 pcs.
Power:	800 W / 1,010 W	1,010 W / max. 1,750 W	1,500 W
Transportation frame:	-	- / -	optional
Weight:	12.0 kg / max. 18.2 kg	14.5 kg / max. 134.5 kg	175.0 kg
Page	146	146	147

Threading & grooving

Threading manual

SUPER CUT

Ratchet threader Ø 1/4 - 2"

For production of precise and reliable thread connections according EN 10226 on threaded pipe according EN 10255 M / H



Product profile

APPLICATION AREA

For threading of
BSPT right: Ø 1/4 - 2"

KEY FEATURES

- Slim, compact design with excellent overall size, ratchet angle of 22.5°
- Easy operation in hard-to-reach places with the offset lever
- Convenient, lockable reversal of the ratchet direction
- Extremely long service life
- Simple insertion and removal of die heads
- Secure hold with retainer locking
- Perfect centering through the long pipe guide is ensured
- Optimised cutting geometry allows a gentle first cut and excellent chip discharge

Power optimisation with the offset hand lever!

Quick change die heads

Secure hold

Positive octagonal universal drive with retainer locking

Fits all ROTHENBERGER manual and power threaders

Simple insertion and removal of the die heads

6



Long lever
Optimum force transfer

Offset lever
Easy operation in hard-to-reach places

Quick adjustment
Convenient, lockable reversal of the ratchet direction

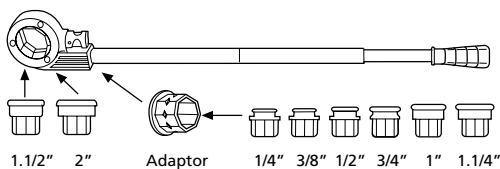
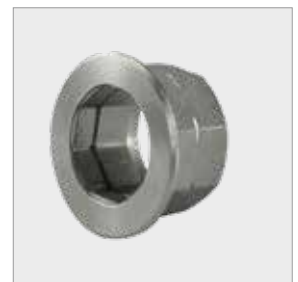
Made of high quality tempered steel
Extremely long service life

SUPER CUT when working at the building site



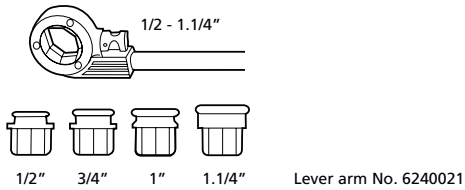
With ratchet handle 1/4" - 2" the attachment of the 1/4" - 1.1/4" die head results with the use of the adaptor (No. 600011500)

Monoblock - adaptor (No. 600011500)



SUPER CUT sets Ø 1/2 - 1.1/4"

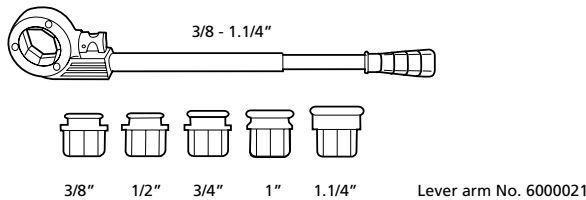
With ratchet handle (small octagonal drive, No. 070840X) and die heads in plastic carrying case (No. 70780)



Model	Description	kg	No.
BSPT R	1/2" - 3/4" - 1"	4.2	070780X
BSPT R	1/2" - 3/4" - 1" - 1.1/4"	5.1	070781X

SUPER CUT sets Ø 3/8 - 1.1/4"

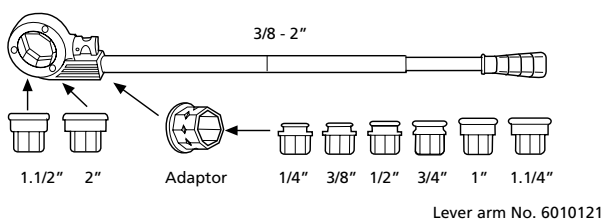
With ratchet handle (small octagonal drive, No. 070840X) and die heads in RO CASE 4414 (No. 1300003541)



Model	Description	kg	No.
BSPT R	3/8" - 1/2" - 3/4" - 1" - 1.1/4"	6.2	070790X

SUPER CUT sets Ø 3/8 - 2"

With ratchet handle (large octagonal drive, No. 71272), die head adaptor (No. 71273) and die heads in RO CASE 4414 (No. 1300003541)



Model	Description	kg	No.
BSPT R	3/8" - 1/2" - 3/4" - 1" - 1.1/4" - 1.1/2" - 2"	11.4	070891X
BSPT R	1/2" - 3/4" - 1" - 1.1/4" - 1.1/2" - 2"	10.8	070892X

ACCESSORIES

Description	
Die heads 1/4 - 2"	138
Dies 1/4 - 2"	138
Cutting fluid	139
Pipe roughing wrench	145
Ratchet pipe deburrer 1/4 - 2"	145



Threading & grooving

Threading manual

SANI KIT

Tool set in sturdy plastic carrying case

Ideal for repair and installation jobs requiring complete steel pipe processing



Product profile

APPLICATION AREA

Cutting:	Up to Ø 1.1/4"
Thread cutting:	Up to Ø 1"
Assembly, screwing, loosening, sealing of thread connections:	Up to Ø 1.1/4"

KEY FEATURES

- Light and easy to use, always within reach
- Secure guiding of the cutter wheel on the pipe
- Reliable grip with the s-shaped jaw
- Firm grip even with heavy-duty use
- Long service life
- Precise thread cutting to approved standards
- Perfect alignment

Steel pipe cutter Super 1.1/4"

Wide rollers

Secure guiding of the cutter wheel on the pipe

Corner pipe wrench Super S

Slim, s-shaped jaw

Firm grip



SUPER CUT ratchet threader

With SUPER CUT ratchet handle 1.1/4"

Perfect alignment

Small outer octagon, BSPT R 1/2 - 3/4 - 1"

Precise thread cutting to approved standards

Water pump pliers type SP

With heavy duty box joint, chrome vanadium steel, drop-forged and tempered

Long service life

Polished head and joint

Firm grip even with heavy-duty use

6



SANI KIT

Tool carrying case

Ideal for repair and installation jobs requiring complete steel pipe processing

The ideal installation set!

SANI KIT when working at the building site with RONOL



10-part set (No. 70600) includes: SUPER CUT ratchet threader 1.1/4" (No. 070840X), quick-change die heads BSPT R 1/2" (No. 070823X) - 3/4" (No. 070824X) - 1" (No. 070825X), steel pipe cutter SUPER 1.1/4" (No. 70040), water pump pliers type SP 10" (No. 70528), corner pipe wrench 1" (No. 070122X) as well as teflon tape (No. 855360), in plastic carrying case



6

Model	kg	No.
SANI KIT tool set	8.2	70600

SUPER CUT ratchet arm

With offset adaptor



Direct seating for die heads	via adaptor for die heads	Handle	kg	No.
1/4" - 1.1/4"	-	2 pcs.	1.7	070840X
1.1/2" - 2"	1/4" - 1.1/4"	3 pcs.	2.5	71272



ACCESSORIES

Description	
Die heads 1/4 - 2"	138
Dies 1/4 - 2"	138
Cutting fluid	139
Pipe roughing wrench	145
Ratchet pipe deburrer 1/4 - 2"	145



Threading & grooving

Threading electric

SUPERTRONIC 1250

Power threader Ø 1/4 - 1.1/4"

For quick and effortless production of precise and reliable thread connections to approved standards



Product profile

APPLICATION AREA

For threading of

BSPT right:	Ø 1/2 - 1.1/4"
Optional (not included in set):	Ø 1/4", 3/8"
NPT:	Ø 1/4 - 1.1/4"

KEY FEATURES

- Ideal for confined spaces (corners, shafts)
- Sturdy and light, even with heavy-duty use
- Compact gear housing with excellent overall size
- High power transmission, quiet running with long service life
- Tough, rugged and durable
- Weight reduction and easy handling

KEY FEATURES

- Die head can be used in both directions (left and right)
- Stable speed by forward and reverse motion

TECHNICAL DATA

Threading speed:	15 - 20 rpm
Rapid reverse speed:	27 rpm
Performance:	800 W
Current:	230 / 110 V
Weight:	4.9 kg
Dimensions:	456 x 168 x 76 mm

6



Ideal for portable operation due to its compact design and weight of only 4.9 kg



Small head shape (11 cm)



Pipe roughing



SUPERTRONIC 1250 set

Set includes: SUPERTRONIC 1250 up to Ø 1.1/4" with forged pipe clamp (No. 865008700), precision die heads complete in plastic carrying case (No. 995858100)

Small – Fast – Light



Pipe clamp

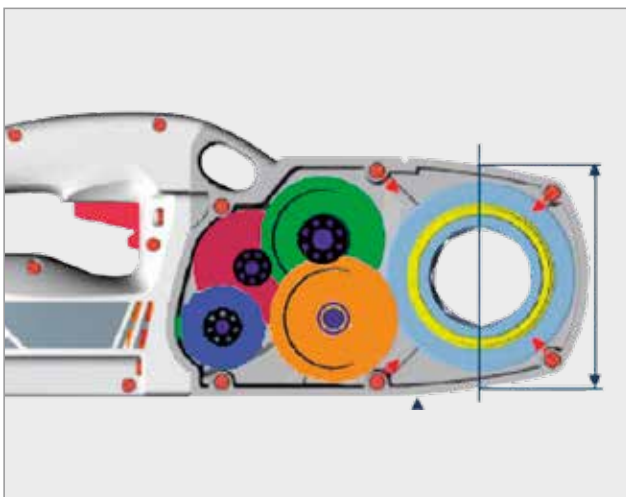


Fig. SUPERTRONIC 1250 set (No. 71450)

6

Model	Description	kg	230 V	110 V
SUPERTRONIC 1250 set, NPT	1/2 - 3/4 - 1 - 1.1/4"	13.0	71454	71453
SUPERTRONIC 1250	with forged pipe clamp, without die heads	3.9	71470	
Pipe clamp for SUPERTRONIC 1250	Up to max. 1.1/4"	1.6	865008700	865008700

Helical gears for maximum power (800 W)



Portable, fast and easy steel pipe processing



ACCESSORIES

Description	
Die heads 1/4 - 2"	138
Dies 1/4 - 2"	138
Cutting fluid	139
Pipe roughing wrench	145
Ratchet pipe deburrer 1/4 - 2"	145



Threading & grooving

Threading electric

SUPERTRONIC 2000

Power threader \varnothing 1/4 – 2"

For quick and effortless production of precise and reliable thread connections to approved standards



Product profile

APPLICATION AREA

For threading of

BSPT right: \varnothing 1/4 - 2"

NPT: \varnothing 1/4 - 2"

High reduction gears with spur wheel teeth, induction tempered, 7 parallel gear shafts, each ball bearing mounted

High, consistent power transmission when fully loaded

Performance:

Strong 1,010 W motor, double insulated with VDE and CEE, interference free for reliable long-term use

Threading speed:

15 - 25 rpm, rapid reverse 60 rpm
(4 x faster reverse with reverse drive)

Maintenance friendly with continuous lubrication

KEY FEATURES

- Secure grip in both turning directions with the hardened, interlocking prism pipe clamp
- Die heads are held firmly in place through direct seating with tension ring locking
- Off-set die head mounting allows for threading even close to walls
- Ideal for confined spaces (corners and shafts)
- User-friendly work with the large mechanism for switching directions
- Reliable motor for long-term use

6



Easy insertion of the die heads



Use with roll grooving tool ROGROOVER



ROFIX adaptor (No. 71271)



High reduction gears

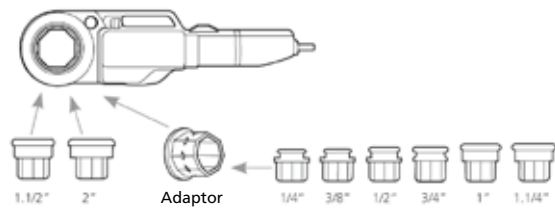




SUPERTRONIC 2000 set

Set includes: SUPERTRONIC 2000 with pipe clamp (No. 71280), ROFIX adaptor (No. 71271), and precision die heads, ROCASE 6414 (No. 1000001953) with inlay

Can also be used in combination with a roll grooving tool!



6

Model	Description	kg	230 V	110 V
SUPERTRONIC 2000 set, BSPT R	1/2" - 3/4" - 1" - 1.1/4" - 1.1/2" - 2"	14.5	71256	71258
SUPERTRONIC 2000 set, NPT	1/2" - 3/4" - 1" - 1.1/4" - 1.1/2" - 2"	14.5	71257	71259
SUPERTRONIC 2000	with forged pipe clamp, without die heads	6.8	71250	71251
SUPERTRONIC 2000 set	in ROCASE with ROFIX and forged pipe clamp	11.2	1000002011	1000002016

Work in confined spaces



Die heads with the tripod universal workbench



ACCESSORIES

Description	
Die heads 1/4 - 2"	138
Dies 1/4 - 2"	138
Cutting fluid	139
Pipe roughing wrench	145
Ratchet pipe deburrer 1/4 - 2"	145



Threading & grooving

Threading electric

SUPERTRONIC 2000 E

Battery driven power threader Ø 1/4 – 2"

For quick and effortless production of precise and reliable thread connections to approved standards



Product profile

APPLICATION AREA

For threading of

BSPT right: Ø 1/4 - 2"

NPT: Ø 1/4 - 2"

High reduction gears with spur wheel teeth, induction tempered, 7 parallel gear shafts, each ball bearing mounted

Threading speed:

15 - 25 rpm, rapid reverse 60 rpm
(4 x faster reverse with reverse drive)

Product dimension: 590 x 140 x 180 mm

Product weight: 6.6 kg

KEY FEATURES

- 4-times faster retraction due to reverse gear unit
- User-friendly operation thanks to large changeover switch for forward and reverse motion
- Firm seating of the cutting heads due to direct mounting with snap ring locking
- Thread cutting close to the wall due to off-center cutting heat cutting head mounting
- Ideal for hard-to-reach places (corners, shafts)
- Secure hold in both directions of rotation due to hardened, prism toothed counterholder
- Easy to maintain thanks to permanent lubrication and brushless motor

6

Toolless Speed-Lock die head mounting

For a fast and fixed connection

Compact and rectangular construction

Optimized for places, that are hard to reach, like corners or shafts, and for working safely on a work bench

Brushless motor

For wear-free work and longer machine life



Off-set die head mounting

Threading possible even close to walls

DuraEasyCut

Optimized geometry for reduced effort of up to 20% for person and machine

Powerful 18V battery

For cutting up to 8 threads (2" BSPT) with only one battery load (Li-Power 18V/4.0 Ah)

Easy switching from forward to an even faster reverse

For working more efficiently

Easy insertion of the die head with tension locking ring



Compatible with with rolling groover ROGROOVER 1-6"



Work in confined spaces



Threading & grooving

Threading electric

SUPERTRONIC 2000 E set

Set includes: SUPERTRONIC 2000 E basic device, pipe clamp (No. 71280), ROFIX adaptor (No. 71271), ROCASE 6414 with inlay (No. 100001953)

Can also be used as a drive for our roll grooving unit!



Description	kg	No.
SUPERTRONIC 2000 E basic device, with pipe clamp	9.8	100003387
SUPERTRONIC 2000 E Set, with pipe clamp, with ROFIX adaptor, without battery and without charger, with BSPT R 1/2"-3/4"-1"-1.1/4"-1.1/2"-2" die heads	12.2	100003388
SUPERTRONIC 2000 E Set, with pipe clamp, with ROFIX adaptor, with battery Li-Power, 4.0Ah 18V and battery charger, with BSPT R 1/2"-3/4"-1"-1.1/4"-1.1/2"-2" die heads	18.1	100003389



No. 100001653



No. 100002548



No. 100002549

Description	kg	No.
RO BP18/4, 4.0Ah 18V Li-Power battery	0.66	100001653
RO BP18/4, 4.0Ah 18V Li-HD battery	0.59	100002548
RO BP18/8, 8.0Ah 18V Li-HD battery	0.98	100002549
RO BC 14/36 battery charger, 230 V, EU	0.58	100001654



ACCESSORIES

Description	
Die heads 1/4 - 2"	138
Dies 1/4 - 2"	138
Cutting fluid	139
Pipe roughing wrench	145
Ratchet pipe deburrer 1/4 - 2"	145



Threading & grooving

Threading electric

Precision die heads

With enlarged shaving discharge chambers

For faster threading, reinforced locking plate and precise die seating. Fits in ROTHENBERGER SUPERTRONIC 1000, SUPERTRONIC 1250, SUPERTRONIC 2000 and SUPER CUT threaders

Threading die heads with optimized geometry

Reduced effort of up to 10% for person and machine

Precision threading dies

Special viscous hard steel with long service life

Big chamber

Faster and easier removal of metal chips



Fully automatic production process

Reduced production tolerances to increase the service life by up to 10%

Extra wide and exchangeable threading dies

Highest demands and long service life

Forcelocked octagonal universal drive with snap ring locking

Easy and tool-free assembly with secure hold



6

Product profile

KEY FEATURES

- Threading die heads with optimized geometry to reduce the effort by up to 10% for person and machine
- Reduced manufacturing tolerance for quicker performance
- Interchangeable threading dies to increase economic efficiency
- Quick change threading die heads with secure holding for SUPER CUT, SUPERTRONIC 1250 and 2000 models

BSPT R	No.	NPT	No.
1/4"	070821X		
3/8"	070822X	3/8"	070908X
1/2"	070823X	1/2"	070912X
3/4"	070824X	3/4"	070913X
1"	070825X	1"	070914X
1.1/4"	070826X	1.1/4"	070915X
1.1/2"	070842X	1.1/2"	070849X
2"	070843X	2"	070850X

Threading dies

Precision threading dies

- Gentle first cut, extremely long life, 4 pieces / pack
- Optimum results are achieved with original ROTHENBERGER thread cutting fluid



BSPT R	No.	NPT	No.
1/4"	070831X	3/8"	070917X
3/8"	070832X	1/2"	070918X
1/2"	070833X	3/4"	070919X
3/4"	070834X	1"	070920X
1"	070835X	1.1/4"	070921X
1.1/4"	070836X	1.1/2"	070945X
1.1/2"	070869X	2"	070946X
2"	070870X		

ROFIX adaptor

Fits small external octagonal die heads from Ø 1/4 - 1.1/4"

- Easy insertion of the die head with tension ring locking



Tension ring locking

Model	kg	No.
ROFIX adaptor with tension ring locking	0.8	71271

RONOL

High-performance cutting oil

Product profile

KEY FEATURES

- Excellent cooling and lubricating properties
- Durability of the threading die is increased considerably
- For perfect, clean threads
- Safe for skin contact
- Also suitable as cold lubrication when cutting metal

TECHNICAL DATA

Mineral-based oil

For threading of all materials including stainless steel

Emulsifying agent enables easy rinsing of the pipeline without unhealthy polychlorinated biphenyl (PCB)

Mineral-based cutting oil is not permitted for drinking water installations - Please check your national regulations!

Model	Contents	kg		No.
RONOL spray can	600 ml	0.58	12	65008
RONOL canister	5 l	4.60	1	65010



6

RONOL SYN

High-performance cutting fluid

Product profile

KEY FEATURES

- Excellent cooling and lubricating properties
- Able to handle high pressure
- Longer life for the cutting tool
- Safe for skin contact
- Also suitable as cold lubrication when cutting metal

TECHNICAL DATA

No mineral-based oils, purely synthetic: developed and approved for drinking water and plumbing installations. DVGW tested.

100% water soluble, physiologically neutral, silicone-free: easily washable

Emulsifying agent enables easy rinsing of the pipeline

No build-up of shavings: perfect cooling quality

Good corrosion protection: no rusting

Undiluted application

High polymer, without EP-additives such as sulphur, phosphorus or chlorine: increased cutting performance



Model	Contents	kg		No.
RONOL SYN spray can	600 ml	0.75	12	65013
RONOL SYN canister	5 l	5.20	1	65015



Threading & grooving

Threading electric

ROPOWER 50 R

Portable compact threader Ø 1/4 - 2"

Quick and effortless production of precise and reliable pipe and bolt threads to approved standards



Product profile

APPLICATION AREA

Use on building sites, for repairs and service, industrial use and for installation work

For threading of:

BSPT right, EN 10226, ISO 7-1:	Ø 1/4 - 2"
NPT, ASME B1.20.1:	Ø 1/4 - 2"
BSPP, ISO 228-1, DIN 259:	Ø 1/2 - 2"
BSW, B. S 84:	Ø 3/8 - 2"
Metric, ISO 261, DIN 13:	Ø 10 - 24 mm

KEY FEATURES

- Quick and reliable threading, trimming, deburring, and grooving
- Effortless and comfortable transport with the light, navigable working carriage, which also serves as a workbench
- Complete pre- and post-processing of pipes
- Easy to maintain machine design
- Die head type R (automatic with integrated oil feed)
- Portable transport frame (standard)

TECHNICAL DATA

Performance:	1,150 W
Speed:	40 rpm
Weight:	68 kg
Dimensions (L x W x H):	535 x 430 x 340 mm

6

Pre- and post-processing of pipes

Self-centering pipe cutter

Precise cuts

Internal deburrer, snap in, 3-blade

Burr-free work

Impact hammer chuck with maximal clamping-force

No pipe slippage

Self-centering rear chuck

Quick and precise alignment of the pipe

Easy to maintain machine design

Motor double insulated in accordance with VDE

Safe operation

Stable high torque motor

Constant power transferral

Off-set spindle lubrication

Easy maintenance

Machine slightly angled

Reduced oil consumption, oil coating in pipe interior is avoided

Original RIDGID²⁾ threading dies can optionally be used!



Geared oil pump with filter system and adjustable fluid qualities

Constant oil flow quantities

Large plastic shavings collection trough

Easy to clean

¹⁾ Complete terms and conditions at rothenberger.com/roservice
RO SERVICE+ only valid in participating countries

²⁾ RIDGID is a registered trade mark of the Emerson Electric Co., St. Louis, USA

ROPOWER 50 R

Set includes: ROPOWER 50 R, automatic die head 1/2" - 2" (No. 56052), SS dies BSPT 1/2" - 3/4" (No. 056370X), 1" - 2" (No. 056371X), safety foot switch (No. 56335), collapsible stand (No. 56051), tool

Die head type R

Automatic die head with integrated oil feed

Long life of the die heads

Optimal lubrication and cooling of the die heads

Long life of the die heads

Transportation frame

(Included in delivery)

Carriage with storage space and a mount for the foot switch

Clearly arranged work

Collapsible undercarriage

Comfortable transport

With 2 plastic wheels

High mobility

Safety foot switch (No. 56335)

Increased safety

Fig. collapsible stand (No. 56051) included in delivery!

6

Automatic die head with integrated oil supply



High mobility



Thread roughing



Cost-effective production of grooves



Model	Volt	kg	No.
ROPOWER 50 R with automatic die head:			
BSPT R 1/2 - 3/4", 1-2"	230 V	88.5	56050
BSPT R 1/2 - 3/4", 1-2"	110 V	88.5	56045
BSPP R 1/2 - 3/4", 1-2"	230 V	88.5	56057
Collapsible stand ROPOWER 50 R		19.2	56051
Spare cutting wheel (PANDA 40, PANDA 90, PISET 3 SG, Nr. 6 SC 2 S, 2 SE, 3 S, 3 SE, 4 S, 4 SE)		0.02	70074
Supporting bolt for transport frame (4 pcs.)		0.7	56049
Supporting legs (4 pcs.)		5.0	56488

ACCESSORIES

Description	No.
Cutting fluid	139
Automatic die heads	144
Threading dies	144
NIPPEL MAX	145
Pipe roughing wrench	145 56500
ROGROOVER 1-6"	146 56505



Threading & grooving

Threading electric

SUPERTRONIC 2 SE / 3 SE / 4 SE

Compact threader Ø 1/4 - 4"

Reliable and proven for constant professional use



Product profile

APPLICATION AREA

- Ideal for portable and stationary threading in the workshop, on-site, for repairs and service, trade and industry, pipeline construction as well as for sanitary and heating installations
- Universal application, with or without stand, i.e. on a workbench

For threading of:

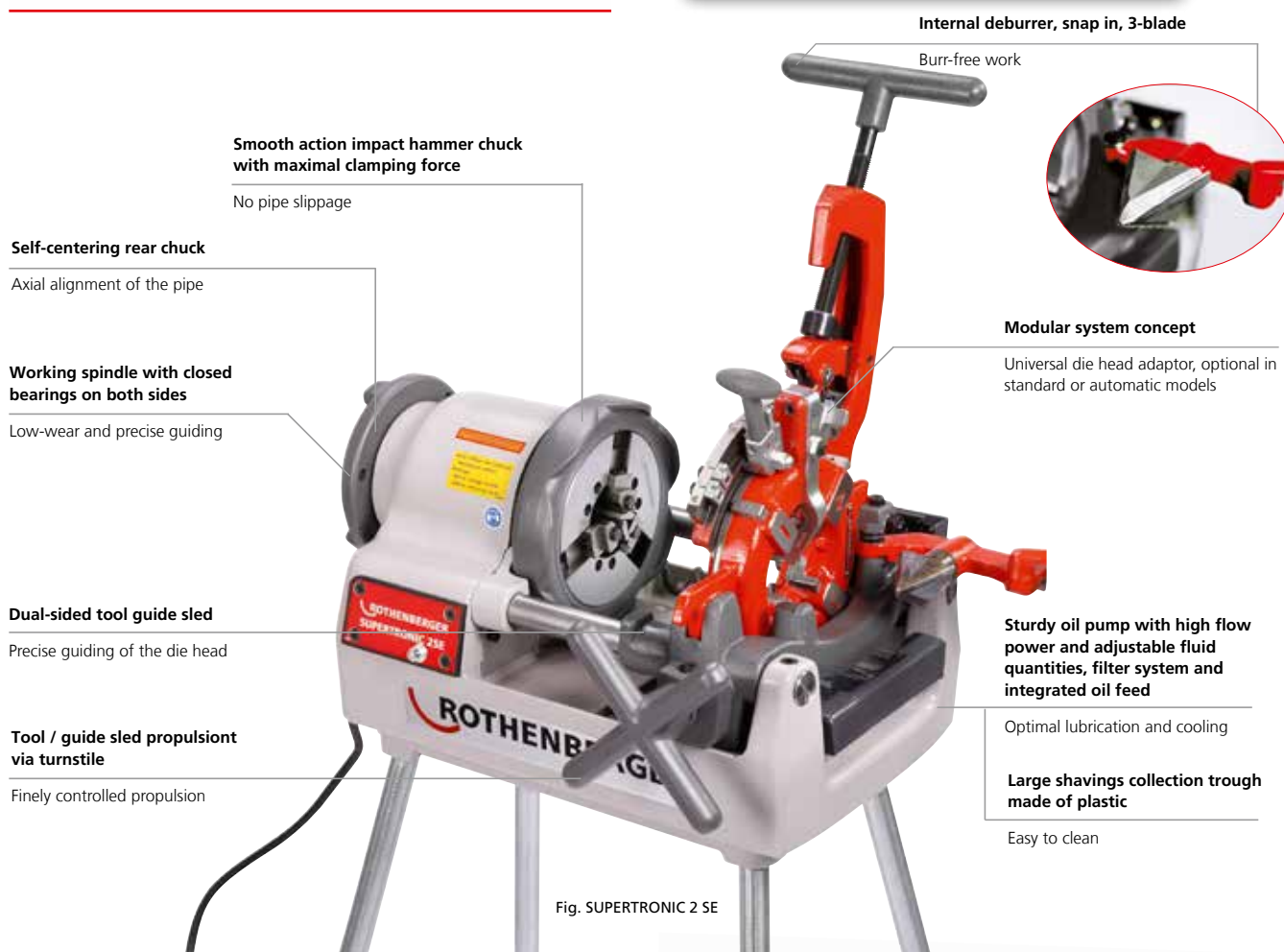
BSPT right, EN 10226, ISO 7-1:	Ø 1/4 - 2"
NPT, ASME B1.20.1:	Ø 1/4 - 2"
BSPP, ISO 228-1, DIN 259:	Ø 1/2 - 2"
BSW, B. S 84:	Ø 3/8 - 2"
Metric, ISO 261, DIN 13:	Ø 10 - 36 mm
	Ø 10 - 24 mm (2 SE)

KEY FEATURES

- Universal die head seating (standard or automatic)
- Precise guiding of the die head
- Low-wear and precise guiding
- Fast axial alignment of the pipe
- No pipe slippage due to impact hammer chuck
- Burr-free work

Can also be used in combination with a roll grooving tool!

6



Impact hammer chuck with inter-changeable clamping jaw, optimal clamping properties through flexible adjustment and broad support



Automatic die heads with quick adjustment of thread size, automatic thread length and finely adjustable thread depth without recentering



Threading & grooving

Threading electric

SUPERTRONIC 2 SE

Compact threader Ø 1/2 - 2"

Standard die head: 1/2 - 2" (No. 56156)
Automatic die head: 1/2 - 2" (No. 56266)



TECHNICAL DATA

Power:	1,150 W
Speed:	40 rpm
Weight, with die heads:	68 kg
Dimensions (L x W x H):	535 x 430 x 340 mm

Set includes: SUPERTRONIC 2 SE, automatic die head 1/2 - 2" (No. 56165) or automatic die head (No. 56266), SS threading dies 1/2 - 3/4" (No. 56003), 1 - 2" (No. 56007), safety foot switch (No. 56335), supporting legs (No. 56488), tool

SUPERTRONIC 2 SE	kg	230 V
with standard die head	68	56150
BSPT R 1/2 - 3/4", 1 - 2"		
with automatic die head	68	56175
BSPT R 1/2 - 3/4", 1 - 2"		

SUPERTRONIC 2 SE

No.

Deburrer without holder for 2 SE	56198
Supporting legs (4 pcs.)	56488

SUPERTRONIC 3 SE

Compact threader Ø 1/2 - 3"

Standard die head: 1/2 - 2" (No. 56156), 2 - 3" (No. 56104)
Automatic die head: 1/2 - 2" (No. 56266), 2.1/2 - 3" (No. 56288)



TECHNICAL DATA

Power:	1,700 W
Speed:	33 rpm
Weight, with die heads:	100 kg
Dimensions (L x W x H):	650 x 480 x 420 mm

Set includes: SUPERTRONIC 3 SE, standard die heads 1/2 - 2" (No. 56156) or automatic die heads (56266), standard die head 2 - 3" (No. 56104) or automatic die head 2 1/2 - 3" (56288), SS threading dies 1/2 - 3/4" (No. 56003), 1 - 2" (No. 56007), SS threading dies 2 - 3" (No. 56006), SS threading dies 2 1/2 - 3" (No. 56489), safety foot switch (No. 56335), supporting legs (No. 56491), tool

SUPERTRONIC 3 SE	kg	230 V	110 V
with standard die head	100	56250	56253
BSPT R 1/2 - 3/4", 1 - 2", 2 - 3"			
with automatic die head	100	56255	
BSPT R 1/2 - 3/4", 1 - 2", 2.1/2 - 3"			

SUPERTRONIC 3 SE

No.

Deburrer without holder for 3 SE	56199
----------------------------------	--------------

SUPERTRONIC 4 SE

Compact threader Ø 1/2 - 4"

SUPERTRONIC 4 SE with automatic die head



Lever

Various adjustable speeds

TECHNICAL DATA

Power:	1,750 W
Speed:	22 / 50 rpm
Weight, with die heads:	120 kg
Dimensions (L x W x H):	750 x 540 x 480 mm

Set includes: SUPERTRONIC 4 SE, BSPT automatic die head 1/2 - 2" (No. 56266), BSPT automatic die head 2 1/2 - 4" (No. 56289), SS threading dies 1/2 - 3/4" (No. 56003), SS threading dies 1 - 2" (No. 56007), SS threading dies 2 1/2 - 4" (No. 56294), safety foot switch (No. 56335), supporting legs (No. 56489), tool

SUPERTRONIC 4 SE	kg	230 V	110 V
with automatic die head	120	56465	56475
BSPT R 1/2 - 3/4", 1 - 2", 2.1/2 - 4"			
NPT 1/2 - 3/4", 1 - 2", 2.1/2" - 4"		56466	
Deburrer without holder for 4 SE		56200	
Transport frame for 3 and 4 SE	25	57050	

¹⁾ Complete terms and conditions at rothenberger.com/roservice
RO SERVICE+ only valid in participating countries

Threading & grooving

Threading electric

Precision die heads

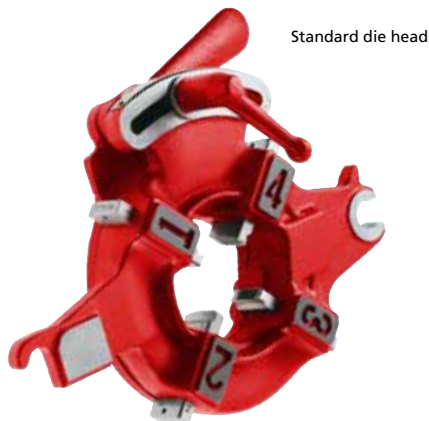
For machine types ROPOWER 50 R, PANDA, PISET, SUPERTRONIC 2 S, 2 SE, 3 S, 3 SE, 4 S and 4 SE

Product profile

KEY FEATURES

Standard die heads

- Time saving with a simple and quick change of the threading dies
- User-friendly with the locking positioning which eliminates complicated calibration
- Longer life of the dies with the integrated lubrication
- Guaranteed consistent cutting oil film on the pipe surface



Product profile

KEY FEATURES

Automatic die heads

- Simple and clear operation with the quick-adjustment thread sizes
- Automatic adjustable thread length for serial production
- Flexible work: Each thread size offers individual fine adjustment of the thread depth without recentering dimension change

Please note: The die heads do not include threading dies!

Overview die heads / threading dies

Die heads			Threading dies			ROPOWER 50 R	SUPERTRONIC 2 SE	SUPERTRONIC 3 SE	SUPERTRONIC 4 SE
Thread type	Size	No.	Size	No. SS-steel	No. HSS-steel stainl. steel/inox pipe				

Automatic die heads suitable for RIDGID® threading dies

BSPT R	1/2 - 2"	56052	1/4 - 3/8"	56369	56379	●			
			1/2 - 3/4"	056370X	56380	●			
			1 - 2"	056371X		●			
NPT	1/2 - 2"	56053	1/4 - 3/8"	56372		●			
			1/2 - 3/4"	56373		●			
			1 - 2"	56374		●			
BSPP		56054	1/2 - 3/4"	56058		●	●	●	●
			1 - 2"	56059		●	●	●	●

Automatic die heads suitable for ROTHENBERGER threading dies

BSPT R	1/2 - 2"	56266	1/2 - 3/4"	56003	56235	●	●	●	●
			1 - 2"	56007	56236				
	2.1/2 - 3"	56288	2.1/2 - 3"	56291	56237				
	2.1/2 - 4"	56289	2.1/2 - 4"	56294	56238				
NPT	1/2 - 2"	56271	1/2 - 3/4"	56111	56180		●	●	●
			1 - 2"	56112	56181		●	●	●
	2.1/2 - 3"	56268	2.1/2 - 3"	56295	56183		●	●	●
	2.1/2 - 4"	56269	2.1/2 - 4"	56296			●	●	●
			3.1/2 - 4"		56184		●	●	●

ROTHENBERGER standard / manual die heads

BSPT R	1/4 - 3/8"	56153	1/4 - 3/8"	56001	56135	●	●	●	●
	1/2 - 2"	56156	1/2 - 3/4"	56003	56235	●	●	●	●
			1 - 2"	56007	56236				
	2 - 3"	56104	2 - 3"	56006	56121				
	3.1/2 - 4"	56032	3.1/2 - 4"	56008	56122				
NPT	1/4 - 3/8"	56118	1/4 - 3/8"	56110		●	●	●	●
	1/2 - 2"	56156	1/2 - 3/4"	56111	56180	●	●	●	●
			1 - 2"	56112	56181	●	●	●	●
	2.1/2 - 3"	56104	2.1/2 - 3"				●	●	●
BSPP	1/2 - 1.1/4"	56076	1/2 - 3/4"			●	●	●	●
			1 - 1.1/4"						
	1.1/2 - 3"	56077	1.1/2 - 2"	56097					
			2.1/2 - 3"	56098					●

Precision threading dies

High material quality and precise workmanship guarantee easy cutting, clean threads and extremely long service life with outstanding chip discharge. Manufactured from high-quality tempered steel (only available in sets 4 or 5 pieces / pack)



For optimal threading results, use only with original ROTHENBERGER cutting fluid or cutting oil (see 139)

Suitable for:

- **Conical pipe threads - BSPT**
Whitworth pipe threads: ISO 7-1, DIN EN 10226 (DIN 2999)
External pipe threads: conical, 1:16, 55° flank angle
- **Conical pipe threads - NPT**
Taper pipe threads: ASME B1.20.1
External pipe threads: conical, 1:16, 60° flank angle
- **Cylindrical pipe threads - BSPP**
Whitworth pipe threads: ISO 228-1, DIN 259
Exterior pipe threads cylindrical, 55° flank angle

® RIDGID is a registered trade mark of the Emerson Electric Co., St. Louis, USA

Pipe supporting column

Adjustable height, from 780 up to 1,200 mm with ball track. Maximum carrying capacity 120 kg



Model	Height / mm	kg	No.
For pipes up to 6"	780 - 1,200	5.8	56047

Replacement safety foot switch

For all ROTHENBERGER threading machines

- Complies with industrial associations' safety and accident prevention requirements
- With oil-proof rubber cable and plug
- Foot switch should not be pushed all the way down (OFF-ON-OFF)



Model	kg	No.
3 step with emergency stop switch, 230 V	2.5	56335

Pipe roughing wrench 3/8 - 2"

Wrench made of forged steel, with hardened rolls. Consistent, thread-saving roughing of the entire area

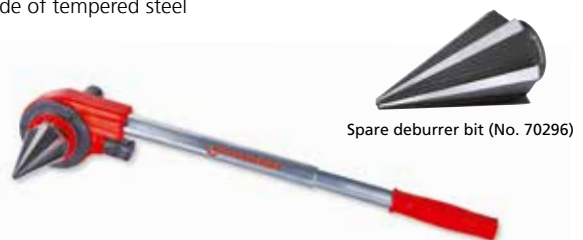


Model	L mm	kg	No.
Pipe roughing wrench	335	1.15	56500
Replacement roughing rolls (3 pcs.)		0.30	56501

Ratchet pipe deburrer 1/4 - 2"

Quick and clean deburring

For steel pipes, with smooth-running ratchet, cutting bit made of tempered steel



Model	inch	mm	g	No.
Internal deburrer with ratchet	1/4 - 2"	13 - 60	2,680	70289
Spare deburrer			200	70296

NIPPEL MAX

NIPPEL MAX Ø 1/2 - 2"

For the production of nipples and double nipples, grips short pipe lengths from within; hardened, sharpened gripping jaws. For all stationary threading machines like PANDA, PISET, ROPOWER and SUPERTRONIC.

- Recycling pipe scraps saves money, material and time
- Automatic quick grip of the pipe piece without the need for additional tools
- Pipes are gripped from within and centred: no damage to pipe piece



Set (No. 56056) includes: nipple chuck 1/2" (No. 56060), 3/4" (No. 56061), 1" (No. 56062), 1.1/4" (No. 56063), 1.1/2" (No. 56064), steel carrying case (No. 26410)

Model	kg	No.
NIPPEL MAX set		
1/2 - 3/4 - 1 - 1.1/4 - 1.1/2"	4.4	56056
Nipple chuck 1/2"	0.4	56060
Nipple chuck 3/4"	0.5	56061

Model	kg	No.
Nipple chuck 1"	0.7	56062
Nipple chuck 1.1/4"	0.8	56063
Nipple chuck 1.1/2"	0.9	56064
Nipple chuck 2"	1.2	56065

Threading & grooving

Roll grooving

Hand roll groover 1 - 12"

Manageable and compact hand roll groover for producing grooves on installed thin- and standard steel pipes up to 12" (324 mm)

Suitable for installations, sprinkler systems, larger heating units, industrial use and mining

APPLICATION AREA

For standard grooves on installed pipes from 1 - 12"

KEY FEATURES

- For pipes from Ø 1"
- Quick connection of pipes anywhere where welding is not allowed!
- Easy transportation due to small dimension
- Adjustable and finely-controlled arrester
- 1/2" ratchet for both adjustment

Can also be used in combination with the SUPERTRONIC 2000 E  p. 136

6

Application on tripod workbench




Fixture for stabiliser



TECHNICAL DATA

Working range: 1 - 12" (324 mm)
Pipe wall-thickness: 1 - 6" SCHL10 + SCHL40
 4 - 6" SCHL40
 8 - 12" SCHL10
Weight: 12 kg
Depth gauge: 2 distance plates included
Dimensions: 195 mm x 210 mm x 210 mm



Model	 kg	No.
Hand roll groover 2 - 6"	12.0	100000212
Roller set 1"	0.59	100000720
Roller set 1.1/4 - 1.1/2"	0.62	100000721
Roller set 2 - 6"	1.00	100000850
Roller set 4 - 6"	2.48	100000722
Roller set 8 - 12"	2.70	100000723

ROGROOVER 1 - 6"

Portable rolling groover for steel pipes up to Ø 6" (168 mm) for rapid rolling grooves on standard and thin-walled steel pipes

Suitable for installations, sprinkler systems, larger heading units, industrial use and mining

APPLICATION AREA

Lightweight and compact design allows for use with the threaders:


SUPERTRONIC 2000 ROPOWER 50 R
 SUPERTRONIC 2 SE SUPERTRONIC 3 SE
 SUPERTRONIC 4 SE

KEY FEATURES

- Quick connection of pipes anywhere where welding isn't allowed
- Long life and little wear
- Easy to transport with the lightweight aluminium casing
- Adjustable and finely-controlled arrester for consistent groove depth
- Convenient, easy and time-saving operation

Extremely light: 12 kg!



Model	 kg	No.
ROGROOVER for SUPERTRONIC 2000	14.5	56509
ROGROOVER for ROPOWER 50 R, SC 2 SE, REX 2"	14.5	56505
ROGROOVER for SUPERTRONIC 3 SE and REX 3"	14.5	56506
ROGROOVER for SUPERTRONIC 4 SE	14.5	56507
ROGROOVER for RIDGID ¹⁾ 300	16.0	56504
ROGROOVER for REX 4"	14.5	56508

Model	No.
Support rail 2"	56510
Support rail 3"	56511
Support rail 4"	56512
Seating adaptor SUPERTRONIC	56514
Pressure roller set for ROGROOVER, 1"	56521
Pressure roller set for ROGROOVER, 1.1/4 - 1.1/2"	56522
Pressure roller set for ROGROOVER, 2 - 6"	56523
Tripod workbench	70751

ROGROOVER 1 - 12"

Electro-hydraulic rolling groover for steel pipes
 Ø 1 - 12" (33 - 324 mm) for rolling grooves



Product profile

APPLICATION AREA

Suitable for installations, sprinkler systems, larger heading units, industrial use and mining

KEY FEATURES

- Pressure rollers toolless adjustable due to revolver-button
- Safe working with foot switch and emergency stop switch, as well as lighting in workplace
- Reliable, powerful 1,500 W motor
- Quick and fine adjustment for groovers and regulation

TECHNICAL DATA

Working range:	1 - 12" (33 - 324 mm)
Pipe wall-thickness:	3 - 10 mm
Weight:	175 kg
Dimensions:	685 x 474 x 960 mm
Voltage:	110 V-50 Hz, 230 V-50 Hz / 60 Hz
Power:	1,500 W
Torque:	36 rpm
Max. working pressure:	27,750 N

Fine adjustment of groover depth and regulation

For optimum results

Control panel

Power supply, light and emergency stop switch

Surrounding steel pipe frame

Protection and carrying frame

Revolver-button with integrated pressure rollers

Easy, fast and toolless



Adjustable pipe support stand

Ball bearing suspensions for easy handling

Function only via foot switch

Safety for the user

3-way adjustment of the pressure rollers size



Drive shaft and measuring tape in the delivery



Model	kg	No.
ROGROOVER 1 - 12", 230 V 50 Hz	175	1500001351
ROGROOVER 1 - 12", 230 V 60 Hz	175	1500001352
ROGROOVER 1 - 12", 110 V 50 Hz	175	1500001353

Set includes: ROGROOVER machine 1 - 12", pipe support stand, drive shaft, 1 - 1.1/2", 2 - 6" and 8 - 12" (No. 1500001709-1711), diameter measuring tape

Model	kg	No.
Pipe support stand	33	1500001990
Diameter measuring tape	0.05	1500000134
Transport stand	25	57050
Spare spindel for Inox tube, 1 - 1.1/2"	1.3	1000002262
Spare spindel for Inox tube, 2 - 6"	1.7	1000002263
Spare spindel for Inox tube, 8 - 12"	2.6	1000002264
Spare spindel for steel tube, 1 - 1.1/2"	1.3	1500001711
Spare spindel for steel tube, 2 - 6"	1.4	1500001709
Spare spindel for steel tube, 8 - 12"	1.7	1500001710



Soldering & welding

System overview	150 - 151
Cartridge brazing	152 - 156, 158 - 159
Cartridge soft soldering	156 - 157, 159
Cylinder brazing	160 - 161
Cylinder soft soldering	162
Accessories cylinder brazing/soft soldering	163
Electric soft soldering	164 - 165
Gas welding	166 - 169
Three-gas welding	170 - 171
Accessories soldering & welding	172 - 181



Soldering & welding

System overview

Cartridge brazing

	SUPER FIRE 3	SUPER FIRE 4	ROFIRE Global	ROFIRE Swivel PRO cyclone piezo	ROFIRE Swivel PRO twin
Soft soldering: 	Up to Ø 35 mm	Up to Ø 35 mm	Up to Ø 35 mm	Up to Ø 42 mm	Up to Ø 64 mm
Brazing: 	Up to Ø 28 mm	Up to Ø 28 mm	Up to Ø 28 mm	Up to Ø 18 mm	Up to Ø 28 mm
Special application:	Shrinking, removal of paint	Shrinking, removal of paint	–	–	–
For use with:	MAPP ¹⁾ gas, Maxigas 400, Multigas 300	MAPP ¹⁾ gas, Maxigas 400, Multigas 300	MAPP ¹⁾ gas, Maxigas 400, Multigas 300	MAPP ¹⁾ gas ²⁾ , Maxigas 400 ²⁾ , Multigas 300 ²⁾	MAPP ¹⁾ gas ²⁾ , Maxigas 400 ²⁾ , Multigas 300 ²⁾
Page	152 - 153	154 - 155	156	156	156

Cartridge soft soldering






Roofing

	ROFLAME 4 ROFIRE 4 PIEZO	ROFIRE 4	ROOFING set
Soft soldering: 	Up to Ø 22 mm	Up to Ø 22 mm	✓
Brazing: 	–	Up to Ø 15 mm	–
Special application:	–	–	Bonding of bituminous sheeting
For use with:	Supergas C 200	Multigas 300	Propane, butane
Page	156	157	162

Cartridges


	MAPP¹⁾ gas	Maxigas 400	Multigas 300	Supergas C 200
Flame temperature:	Up to 2,700 °C	Up to 2,200 °C	Up to 1,900 °C	Up to 1,800 °C
Application:	Soft soldering & brazing	Soft soldering & brazing	Soft soldering	Soft soldering
Valve:	7/16" EU	7/16" EU	7/16" EU	Pierceable cartridge
Content:	800 ml / 400 g	600 ml / 352 g	600 ml / 338 g	314 ml / 190 g
Page	158	159	159	159

Brazing & soft soldering devices

	RE 17	ALLGAS 2000 set	ALLGAS 2000 PS 0.5/2 Compact	ALLGAS Mobile Pro	ROXY 400 L
					
		Fig. similar			
Soft soldering: 	✓	✓	✓	✓	✓
Brazing: 	✓	✓	✓	✓	✓
Welding: 	0.5 - 14 mm	0.2 - 5 mm	–	–	–
Cutting:	12 - 100 mm	–	–	–	–
For use with:	Acetylene, oxygen, Maxigas 400	Acetylene, oxygen	Propane, oxygen	MAPP ¹⁾ gas, oxygen	Maxigas 400, oxygen
Page	170	166	167	168	169

Cylinder brazing & soft soldering


E-soft soldering

	AIRPROP	TURBOPROP	ROTHERM 2000
			
Soft soldering: 	Up to Ø 54 mm	Up to Ø 54 mm	Up to Ø 54 mm
Brazing: 	Up to Ø 22 mm	Up to Ø 28 mm	–
Special-application:	–	–	Soft soldering without flame
For use with:	Propane, butane	Propane, butane	230 V
Page	160	161	164 - 165

Cartridges & cylinders

	Acetylene	Oxygen
		
Application:	Brazing, welding, cutting	Brazing, welding, cutting
Valve:	DIN 477-1	M 10x1 (one-way) / G 3/4" RH
Pressure:	19 bar	110 bar (one-way) / 200 bar
Content:	5 l, 10 l	950 ml (one-way) / 2 l, 5 l, 10 l
Page	172	172

 Soft soldering
Up to 450 °C

 Brazing
450 °C - 1100 °C

 Gas welding
> 1100 °C

¹⁾ MAPP is a registered trademark of the MESSER Group GmbH, Bad Soden

Bonding

Cartridge brazing

SUPER FIRE 3

Ergonomic HEAVY DUTY brazing unit

For brazing up to Ø 28 mm and soft soldering up to Ø 35 mm as well as other applications such as removal of paint or shrinking of hoses



Product profile

APPLICATION AREA

- Brazing:** up to Ø 28 mm (with flame reflector in a wind protected environment)
Soft soldering: up to Ø 35 mm

KEY FEATURES

- Rapid material heat-up, less consumption!
- Long service life
- "Twist 'N' Load" system (5 different burner available) – exchange of the burner with only one movement
- Precise flame adjustment
- Up to 2.5 hours of brazing with one cartridge

KEY FEATURES

- Even more comfortable for longer jobs
- Reliable piezo ignition (up to 30,000 ignitions)
- Double the safety because there is no gas leakage without locked burners (piezo ignition)

TECHNICAL DATA

- Coupling:** 7/16" EU
Handle: Aluminium, bolted
Burner: Brass / stainless steel

"Twist 'N' Load"

Fast "Twist 'N' Load" system

Exchange of the burners with one movement (5 different burners available)

Fine regulating valve

Precise flame adjustment



Ergonomically designed handle

Robust and optimum handling made of high-quality aluminium

Elaborately manufactured brass / stainless steel design

Long service life

Burners with swirl flame

Rapid heat-up, less consumption!

Only ignites if burner has been securely locked

Dual safety

High-performance piezo

Reliable (up to 30,000 ignitions)



Locking button

Continual use with only one hand

ROTHENBERGER MAPP¹⁾ gas

Up to 2.5 hours of brazing with one cartridge

Brazing in gas installation



High flame temperature based on cyclone swirl



Brazing in refrigeration / air-conditioning technology



Pin-point burner (460 °C):



For fine soldering; precise and stable flame

(No. 35455)

Standard burner (700 °C):



For soft soldering and other jobs with lower heat application; precise, powerful and stable flame

(No. 35456)

Cyclone burner (950 °C):



For hard and soft soldering with an efficient swirl flame (allows pipe to heat up evenly)

(No. 35457)

Hot air burner (400 °C):



For the removal of paint and for shrinking work up to approx. 80 mm diameter; wind-stable, powerful current of hot air

(No. 35458)

Shrinking burner (720 °C):



For shrinking up to Ø 300 mm and for heating; powerful, wind-stable soft flame

(No. 35459)

SUPER FIRE 3 HOT BOX

KEY FEATURES

- The ideal service kit
- For repairs, heating installations and refrigeration / air-conditioning technology



5-part set (No. 100002369) includes: handle (No. 35445), cyclone burner (No. 35457), pin-point burner (No. 35455), flame reflector (No. 31043), universal torch support (No. 35461), 2x MAPP[®] gas A cartridges (No. 035521-A), ROCASE 4414 (No. 1000001945)

Model		No.
SUPER FIRE 3 HOT BOX EU (incl. MAPP [®] gas A)	1	1000002369
SUPER FIRE 3 HOT BOX EU (incl. MAPP [®] gas B)	1	1000002370
SUPER FIRE 3 HOT BOX EU (incl. MAPP [®] gas C)	1	1000002371

7

SUPER FIRE 3 basic set

Set (No. 35436) includes:
handle (No. 35445), cyclone burner (No. 35457)

When placing your order, remember to order the universal torch support (No. 35461) for stationary soldering, too!

Model		No.
SUPER FIRE 3 basic set		35436
SUPER FIRE safety adaptor 7/16" to 1"	1	035648X



No. 035648X



No. 35436

ACCESSORIES



Model		Model	
Welding blanket	175	Fittings solder	177
Internal brushes for copper pipes	175	ROVLIES cleaning pads	175
Solder	176 - 181	ROSOL soldering paste	177

¹⁾ MAPP is a registered trademark of the MESSER Group GmbH, Bad Soden

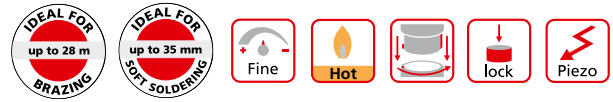
Bonding

Cartridge brazing

SUPER FIRE 4

Ergonomic brazing unit

For brazing up to Ø 28 mm and soft soldering up to Ø 35 mm as well as other applications such as removal of paint or shrinking of hoses



Product profile	
APPLICATION AREA	
Brazing:	up to Ø 28 mm (with flame reflector in a wind protected environment)
Soft soldering:	up to Ø 35 mm
KEY FEATURES	
●	Rapid material heat-up, less consumption!
●	"Twist 'N' Load" system (5 different burner available) – exchange of the burner with only one movement
●	Precise flame adjustment
●	Improved trigger locking mechanism for one-handed-operation

KEY FEATURES	
●	Reliable piezo ignition (up to 30,000 ignitions)
●	Double the safety because there is no gas leakage without locked burners (piezo ignition)
●	Longer handle for an even more stable positioning on the cartridge
TECHNICAL DATA	
Coupling:	7/16" EU
Handle:	Plastic, rubberized
Burner:	Brass / stainless steel

7

Burner with swirl flame

Rapid heat-up, less consumption!

Elaborately manufactured brass / stainless steel design

Long service life

"Twist 'N' Load"

Fast "Twist 'N' Load" system

Exchange of the burner with one movement (5 different burner available)

Optimized fine regulating valve

Precise flame adjustment, faster opening and closing

Dual safety

Only ignites if burner has been securely locked

High-performance piezo

Reliable (up to 30,000 ignitions)

Locking button

Continual use with only one hand

Ergonomically designed handle

Robust, light and slipfree through rubberized surface

- ✓ Safe
- ✓ Fast
- ✓ Reliable

Brazing in refrigeration / air-conditioning technology



High flame temperature based on cyclone swirl



Brazing in refrigeration / air-conditioning technology



Pin-point burner (460 °C):



(No. 35455)

For fine soldering; precise and stable flame

Standard burner (700 °C):



(No. 35456)

For soft soldering and other jobs with lower heat application; precise, powerful and stable flame

Cyclone burner (950 °C):



(No. 35457)

For hand and soft soldering with an efficient swirl flame (allows pipe to heat up evenly)

Hot air burner (400 °C):



(No. 35458)

For the removal of paint and for shrinking work up to approx. 80 mm diameter; wind-stable, powerful current of hot air

Shrinking burner (720 °C):



(No. 35459)

For shrinking up to Ø 300 mm and for heating; powerful, wind-stable soft flame

SUPER FIRE 4 HOT BOX

KEY FEATURES

- The ideal service kit
- For repairs, heating installations and refrigeration / air-conditioning technology



5-part set (No. 1000002364) includes: handle (No. 1500001354), cyclone burner (No. 35457), pin-point burner (No. 35455), flame reflector (No. 31043), universal torch support (No. 35461), 2x MAPP¹⁾ gas A cartridges (No. 035521-A), ROCASE 4414 (No. 1000001945)

Model		No.
SUPER FIRE 4 HOT BOX EU (incl. MAPP ¹⁾ gas A)	1	1000002364
SUPER FIRE 4 HOT BOX EU (incl. MAPP ¹⁾ gas B)	1	1000002366
SUPER FIRE 4 HOT BOX EU (incl. MAPP ¹⁾ gas C)	1	1000002368
SUPER FIRE 4 HOT BOX US (incl. MAPP ¹⁾ gas US)	1	1000001630

SUPER FIRE 4 basic set

Set (No. 1500001355) includes:
handle (No. 1500001354), cyclone burner (No. 35457)

When placing your order, remember to order the universal torch support (No. 35461) for stationary soldering, too!

Model		No.
SUPER FIRE 4 basic set	1	1500001355
SUPER FIRE safety adaptor 7/16" to 1"	1	035648X

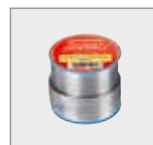


No. 035648X



No. 1500001355

ACCESSORIES



Model		Model	
Welding blanket	175	Fittings solder	177
Internal brushes for copper pipes	175	ROVLIES cleaning pads	175
Solder	176 - 181	ROSOL soldering paste	177

¹⁾ MAPP is a registered trademark of the MESSER Group GmbH, Bad Soden

Bonding

Cartridge brazing/soft soldering

ROFIRE GLOBAL

Ergonomic torch for brazing and soft soldering applications



APPLICATION AREA

- Brazing:** up to Ø28 mm (with flame reflector in a wind protected environment)
Soft soldering: up to Ø 35 mm

KEY FEATURES

- Long service life, with cyclone effect for rapid heat-up
- Reliable up to 30,000 ignitions
- Protection against triggering of the Piezo ignition when falling down accidentally
- Precise flame adjustment
- Durable plastic for ergonomic handling
- Longer handle for stable positioning on gas cartridges

Model	g	No.
ROFIRE GLOBAL, 7/16" EU	250	1500002869

ROFIRE Swivel PRO cyclone piezo

Cyclone burner with piezo ignition

- Coupling:** 1" US
Brazing: up to Ø 18 mm
Soft soldering: up to Ø 42 mm

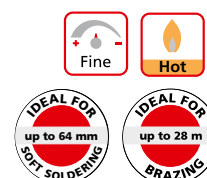


Model	g	No.
ROFIRE Swivel PRO cyclone piezo US	330	35016

ROFIRE Swivel PRO twin

Twin cyclone burner

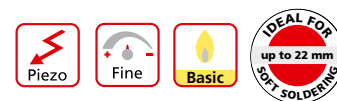
- Coupling:** 1" US
Brazing: up to Ø 28 mm
Soft soldering: up to Ø 64 mm



Model	g	No.
ROFIRE Swivel PRO twin US	400	35012

ROFLAME 4 PIEZO

Ergonomic soft soldering torch for a safe and comfortable usage



APPLICATION AREA

- Soft soldering:** up to Ø 22 mm

KEY FEATURES

- Integrated pre-heat function for a stable flame, even when turning it upside down (360°)
- Robust metal housing for C 200 cartridges
- 2-component rubberized plastic handle for superior ergonomics and handling
- Piezo ignition (up to 30,000 ignitions)
- Precise adjustment of the flame

TECHNICAL DATA

- Coupling:** Pierceable connection (C 200 cartridge)
Handle: Plastic, rubberized
Burner: Stainless steel & brass
Housing: Inox burner, 2-component rubber-plastic handle, metal cartridge housing



Model	g	No.
ROFLAME 4 PIEZO, without gas	630	1000002358



ROFIRE 4

Ergonomic soft soldering torch for a safe and comfortable usage

APPLICATION AREA

Brazing: up to Ø 15 mm
Soft soldering: up to Ø 22 mm

KEY FEATURES

- Integrated pre-heat function for a stable flame, even when turning it upside down (360°)
- Precise adjustment of the flame

TECHNICAL DATA

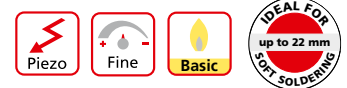
Coupling: 7/16"-EU
Handle: Plastic
Burner: Stainless steel & brass



Model	g	No.
ROFIRE 4, without gas	300	1500002921
ROFIRE 4, with Multigas 300	750	1000002359

ROFIRE 4 PIEZO

Ergonomic soft soldering torch for a safe and comfortable usage



APPLICATION AREA

Brazing: up to Ø 15 mm
Soft soldering: up to Ø 22 mm

KEY FEATURES

- Integrated pre-heat function for a stable flame, even when turning it upside down (360°)
- 2-component rubberized plastic handle for superior ergonomics and handling
- Piezo ignition (up to 30,000 ignitions)
- Precise adjustment of the flame

TECHNICAL DATA

Coupling: 7/16" EU
Handle: Plastic, rubberized
Burner: Stainless steel & brass



Integrated pre-heat function for a stable flame, even when turning it upside down (360°)



Soft soldering in drinking water and heating installation



Model	g	No.
ROFIRE 4 PIEZO, without gas	300	1500002922
ROFIRE 4 PIEZO, with Multigas 300	750	1000002360

Bonding

Cartridge brazing

MAPP¹⁾ gas

High performance brazing and soldering gas

Flame temperatures up to 2,700°C and 35 % faster than propane



Product profile

KEY FEATURES

- Superior heat transfer, higher than propane, especially in winter below 0°C
- Increased safety and stability based on massive brass valve and protective collar
- Provides superior flame performance in any position (360°)

KEY FEATURES

- Easy to use
- Guaranteed constant top torch performance
- Longer periods of use

100 % propylene

Superior flame performance (even upside down) and a higher heat transfer than propane

Steel cylinder

Suitable for high pressure gases

7/16"-EU brass valve

Patented design for high-pressure gases

Protective collar

Stabilizes the torch and protects against accidental drops

7



Protective collar stabilizes the torch and protects against accidental drops



SUPER FIRE 3 HOT BOX



SUPER FIRE 4 HOT BOX

Packaging profile

Model	MAPP ¹⁾ gas
No.	035521-A
EAN code	4004625400180
Product size (mm) (W x H)	70 x 270
Contents (ml)	800
Weight (g)	400
Unit per box	12
Boxes per layer / pallet	10
Layer per pallet	3
Units per pallet	360
Number of pallets per truckload	60
Units per truckload	21,600
Pallet weight (kg)	324
Pallet size (mm) (L x W x H)	800 x 1,200 x 1,000
Carton size (mm) (L x W x H)	290 x 310 x 240

Model	Content		No.
MAPP ¹⁾ gas 7/16" EU, A Languages: DE, GB, FR, ES, IT, PT	800 ml	12	035521-A
MAPP ¹⁾ gas 7/16" EU, B Languages: DK, NL, SE, FI, FR, RUS	800 ml	12	035521-B
MAPP ¹⁾ gas 7/16" EU, C Languages: CZ, PL, HU, BG, TR, RO	800 ml	12	035521-C

Torches can be found starting on 152

Cartridge brazing/soft soldering

Maxigas 400

High-performance welding, cutting and brazing gas for flame temperatures up to 2,200 °C. Gas cartridge with 7/16" EU coupling thread



Multigas 300

Propane / butane gas mixture for flame temperatures up to 1,900 °C. Gas cartridge with 7/16" EU coupling thread



Model	Maxigas 400
No.	035570-A/-B
EAN code	4004625355701 (A)
Product size (mm) (W x H)	65 x 260
Content (ml)	600
Weight (g)	352
Unit per box	24
Boxes per layer / pallet	9
Layer per pallet	3
Units per pallet	648
Number of pallets per truckload	60
Units per truckload	38,880
Pallet weight (kg)	195
Pallet size (mm) (L x W x H)	800 x 1,200 x 1,000
Carton size (mm) (L x W x H)	405 x 272 x 264

Model	Multigas 300
No.	035510-A/-B
EAN code	4004625355107 (A)
Product size (mm) (W x H)	65 x 260
Content (ml)	600
Weight (g)	338
Unit per box	24
Boxes per layer / pallet	9
Layer per pallet	3
Units per pallet	648
Number of pallets per truckload	60
Units per truckload	38,880
Pallet weight (kg)	191
Pallet size (mm) (L x W x H)	800 x 1,200 x 1,000
Carton size (mm) (L x W x H)	405 x 272 x 264

Supergas C 200 TSS

Pierceable butane cartridge with propane contents, also for working at low temperatures. Manufactured according to EN 417:2012, with integrated Top Safe System (TSS). This system prevents uncontrolled gas leakage when accidentally disconnecting it from the device.



Model	C 200 TSS
No.	035901-A/-B
EAN code	4004625390627 (A)
Product size (mm) (W x H)	90 x 95
Content (ml)	330
Weight (g)	190
Unit per box	36
Boxes per layer / pallet	9
Layer per pallet	3
Units per pallet	972
Number of pallets per truckload	60
Units per truckload	58,320
Pallet weight (kg)	350
Pallet size (mm) (L x W x H)	800 x 1,200 x 1,180
Carton size (mm) (L x W x H)	360 x 275 x 280

Bonding

Cylinder brazing

AIRPROP

Propane high-performance torches for brazing up to $\varnothing 22$ mm and soft soldering up to $\varnothing 54$ mm

For brazing and soft soldering of copper and steel pipes up to 2,000 °C without oxygen, as well as warming up, shrinking and flame cleaning



Product profile

KEY FEATURES

- Bundled, concentrated and hot flame with the built-in gas turbine in brazing torch
- Absolutely gas-tight with the optimised valve technology
- Gas-saving operation with the smooth-running economy valve
- Fast burner exchange without tools

TECHNICAL DATA

Self-induced air: Turbine and combustion chamber
Torch: Surface treated, chromed brass
Hose coupling: G 3/8" LH

7

Built-in gas turbine in brazing burner

Bundled, concentrated and hot flame

Smooth-turning economy valve

Gas-saving operation

Optimised valve technology

Absolutely gas tight

Shut-off valve

Prevents uncontrolled gas escape

Absolutely gas-tight connection thanks to dual O-ring technology

Fast burner exchange without tools



No. 31092

Fig. similar

Sets include: safety handle with push-in coupling (No. 211121116), brazing burner with push-in nipple $\varnothing 14$ mm (No. 221131416) / $\varnothing 16$ mm (No. 221131616) / $\varnothing 19$ mm (No. 221131916), propane hose, 2.5 m with 3/8" LH coupling (No. 32201), safety igniter (No. 32077), replacement flints (No. 32088), open-ended spanner (No. 32073), steel case (No. 31005)

Model	kg	No.
AIRPROP brazing set without propane regulator	2.8	31092
AIRPROP brazing set with propane regulator (No. 32081) (W 21.8 LH – G 3/8 LH)	3.1	31091



Threaded coupling M14 x 1

Push-in nipple

AIRPROP brazing burner with threaded coupling

\varnothing mm	L mm	g/h 2 bar	kWh – kcal – BTU	g	No.
14 mm	140	125	1.60 – 1,375 – 5,465	95	30913
16 mm	145	180	2.30 – 3,300 – 7,885	100	30914
19 mm	170	300	3.84 – 3,300 – 13,115	130	30915
22 mm	171	400	5.12 – 4,400 – 26,195	145	30916

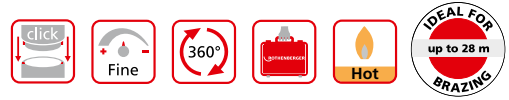
AIRPROP brazing burner with push-in nipple coupling

\varnothing mm	L mm	g/h 2 bar	kWh – kcal – BTU	g	No.
14 mm	140	125	1.60 – 1,375 – 5,465	95	221131416
16 mm	145	180	2.30 – 3,300 – 7,885	100	221131616
19 mm	170	300	3.84 – 3,300 – 13,115	130	221131916
22 mm	171	400	5.12 – 4,400 – 26,195	145	221132216

TURBOPROP

Propane high-performance torch for brazing up to Ø 28 mm and soft soldering Ø 54 mm

For brazing and soft soldering of copper and steel pipes up to 2,200 °C without oxygen, as well as for warming up, shrinking and flame cleaning



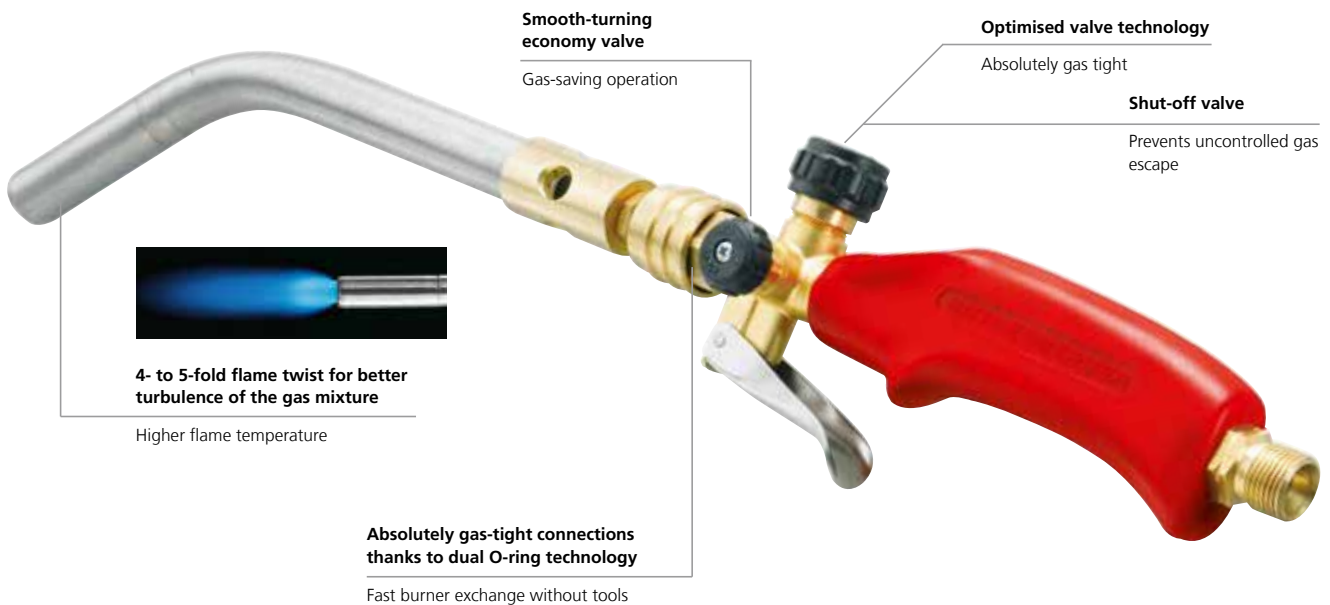
Product profile

KEY FEATURES

- High flame temperature due to turbine with increased oxygen self-induced air and 4- to 5-fold flame chamber
- Fast burner exchange without tools
- Gas-saving operation with the smooth-running economy valve
- Shut-off valve prevents uncontrolled gas escape

TECHNICAL DATA

Self-induced air: Turbine and combustion chamber
Torch: Surface treated, chromed brass
Hose coupling: G 3/8" LH



7



Fig. TURBOPROP burner with push-in nipple



No. 31090

Fig. similar

Sets include: safety handle with push-in coupling (No. 211121116), brazing burner with push-in nipple Ø 12 mm (No. 31032) / Ø 15 mm (No. 221031500) / Ø 18 mm (No. 221031800), propane hose, 2.5 m with 3/8" LH coupling (No. 32201), safety igniter (No. 32077), replacement flints (No. 32088), open-ended spanner (No. 32073), steel case (No. 31005)

TURBOPROP brazing burner with push-in nipple coupling

Model	kg	No.
TURBOPROP set without propane regulator	2.8	31090
TURBOPROP set with propane regulator (No. 32081E) (W 21.8 LH – G 3/8 LH)	3.1	31094

Ø mm	L mm	g/h 2 bar	kWh – kcal – BTU	g	No.
12 mm	175	110	1.41 – 1,210 – 4,815	90	31032
15 mm	195	180	2.30 – 1,980 – 7,855	110	221031500
18 mm	230	240	3.07 – 2,640 – 10,485	160	221031800

Bonding

Cylinder soft soldering

ROOFING set

Propane surface-heating torch with Ø 63 mm high-performance burner



Product profile

APPLICATION AREA

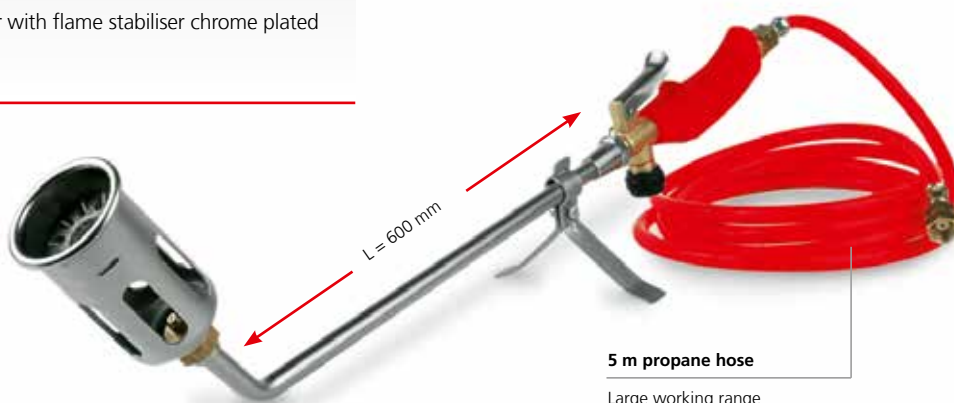
Ideal for roofing and asphalt work and for bonding of bituminous sheeting, large-scale burning of weeds, defrosting, insulation, shrinking, drying and warming up.

KEY FEATURES

- Large working range with 5 m propane hose
- Efficient use even in adverse weather conditions with the flame stabiliser
- High-performance burner with flame stabiliser chrome plated with a reinforced edge
- Burner support

TECHNICAL DATA

600 mm burner tube
Burner support



Ø 63 mm

L = 600 mm

5 m propane hose

Large working range

Burner support included!

7

Ideal for roofing and asphalt work



600 mm burner tube with support and 5.0 m propane hose



5-part set (No. 30954) includes: propane handle (No. 215111216), 63 mm high-performance torch (No. 223216300), 600 mm torch pipe (No. 236010000), 5 m propane hose (No. 32203), torch support (No. 252010000)

Model	g	No.
ROOFING set	1,920	30954
ROOFING set (as No. 30954, with pressure regulator No. 30925)	2,300	30957
Burner support	60	252010000

Extensions

Special tube, chrome plated, angled 40°, inlet M 14 x 1, outlet M 20 x 1



L mm	g	No.	L mm	g	No.
100	90	231010000	350	190	233510000
200	120	232010000	600	290	236010000

Surface-heating burner heads

High-efficiency burner heads with flame stabilisers, made of special chrome plated steel, reinforced edge. For warming up, shrinking, insulating, hardening, general repair work etc. Threaded M 20 x 1 coupling




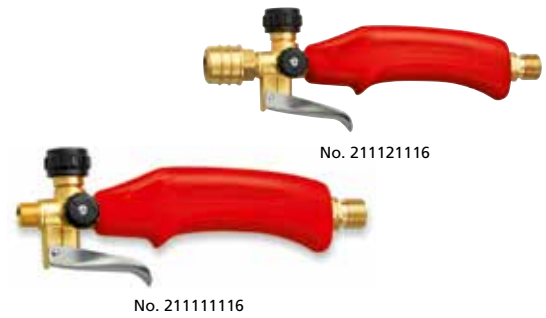
mm	L mm	g/h	kWh	kcal	BTU	g	No.
open							
51	112	3800	48.60	41,800	165,970	270	223090716
63	138	6700	85.70	73,700	292,670	440	223090916
closed							
45	102	2500	32.00	27,500	109,280	240	223214500
51	112	3800	48.60	41,800	165,970	270	223215100
57	126	5500	70.35	60,500	240,257	350	223215700
63	138	6700	85.70	73,700	292,670	440	223216300

Accessories cylinder brazing/soft soldering

Safety propane handles


With economy, regulating and shut-off valves, hose coupling G 3/8" LH

Model			No.
Safety propane handle with push-in coupling	350	211121116	
Safety propane handle with M 14x1 coupling	290	211111116	
Repair kit with shut-off valve, complete	10	30101	
Repair kit with regulating valve, complete	10	30102	



Propane regulators



Brass, for 0.5 kg, 5 kg and 11 kg cylinders

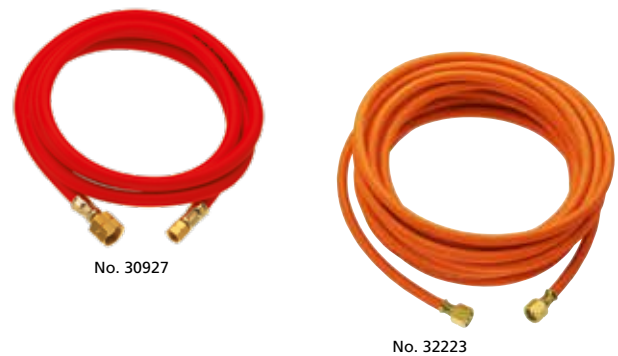
Inlet	Outlet	Working pressure Bar	Performance kg/h		No.
W 21.8x1/14" LH	G 3/8" LH	0.5 - 4.0	8	240	32081
G 3/8" LH	G 3/8" LH	0 - 6	8	200	242206000
W 21.8x1/14" LH	G 3/8" LH	4	8	230	30925



Propane hoses

Top quality, with strong inlay, durable and flexible, mounted with sleeves and nuts, up to 20 bar pressure (2 MPa)

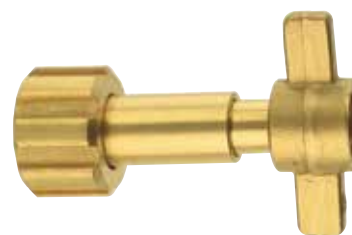
	Inlet	Outlet	Standard	Interior-Ø mm	Wall thickness		No.
2	G 3/8" LH	M 10 x 1 LH	ISO 3821	4.0 x 3.5	310	30927	
2.5	G 3/8" LH	G 3/8" LH	ISO 3821	4.0 x 3.5	350	32201	
5	G 3/8" LH	G 3/8" LH	ISO 3821	4.0 x 3.5	730	33310	
10	G 3/8" LH	G 3/8" LH	EN 1327	5.0 x 3.5	1,650	32223	



Refilling adaptor

For refilling 0.425 kg propane cylinders from 3 kg, 5 kg or 11 kg propane cylinders, brass with guide pin

Inlet	Outlet		No.
W 21.8 x 1/14" LH	G 3/8" LH	160	32207



Propane steel cylinder

With cylinder valve, TÜV tested, according to TRG


Model	Outlet	Content		No.
Small cylinder 0.425 kg, with foot G 3/8" LH empty		2.75	33079	
Protective collar for No. 33079			35636	



Fig. similar

Bonding

Electric soft soldering

ROThERM 2000

Electric soft soldering unit up to Ø 54 mm / 2.1/8"



Product profile

APPLICATION AREA

For simple, safe and time-saving soft soldering without a flame. Particularly suitable for repair and modification work in surroundings or rooms with a fire hazard, as well as in building refurbishment.

Soft Soldering of copper pipes: Ø 6 - 54 mm, 1/4 - 2.1/8"

KEY FEATURES

- Soldering without open flame
- Large working radius, also when working under ceilings
- Comfortable transport and convenient use
- High-performance, short soldering times
- Thermal overload protection turns device off automatically

KEY FEATURES

- Handle shell will not overheat
- No purchasing on handling of gas cylinders necessary
- Equivalent with transport terms
- Connection on every 230 V outlet, 2 m connection cable
- Fast return on investment
- Power control lamp (red) and operating control lamp (green)
- Equipment fuse accessible from outside

TECHNICAL DATA

Power:	2,000 W
Soldergun cable:	4 m
Dimensions (L x W x H):	260 x 190 x 200 mm
Weight:	10.5 kg

Soldering without open flame!

7 **Generously dimensioned stainless steel cooling ribs**

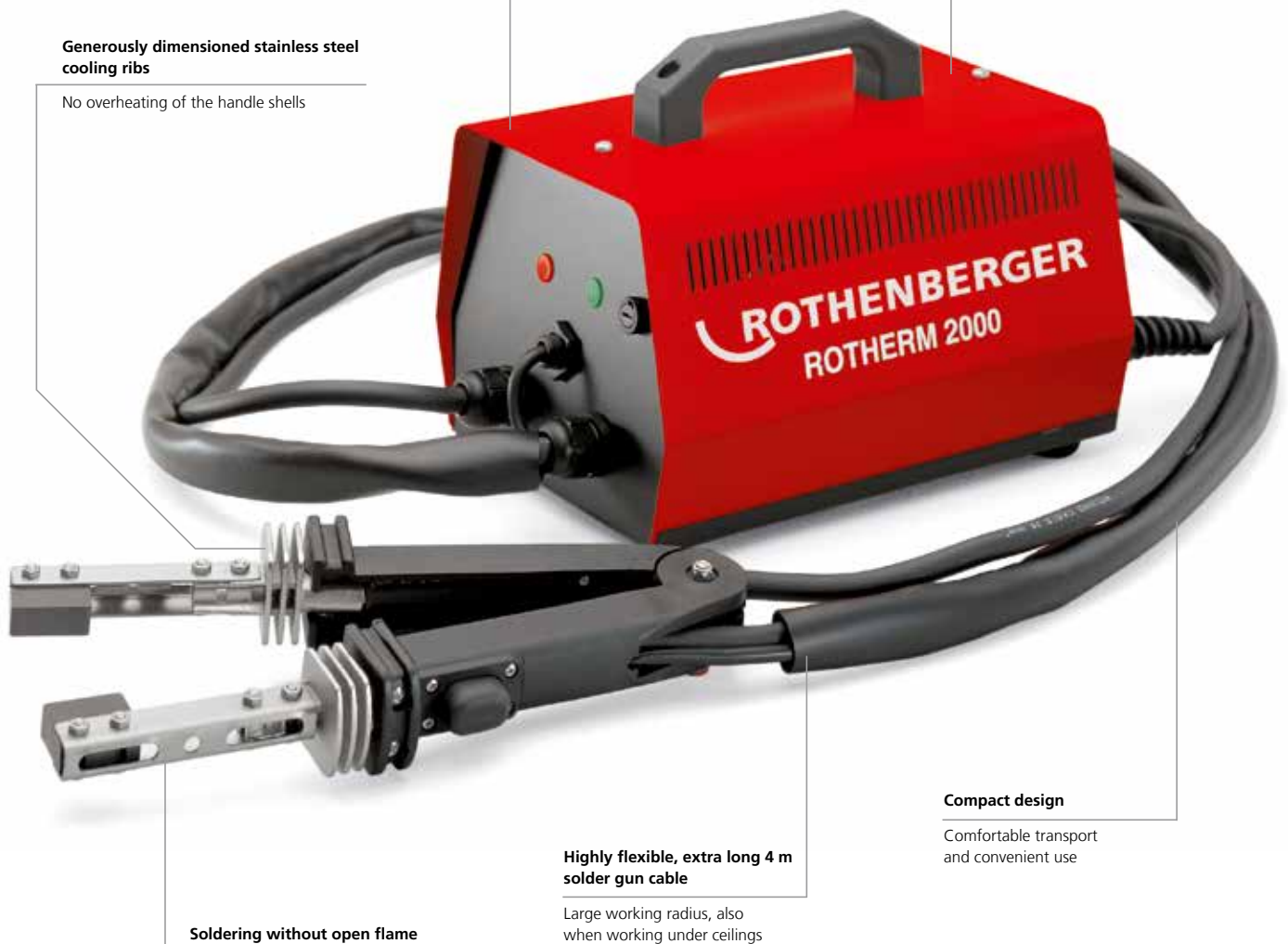
No overheating of the handle shells

Thermal overload protection

Automatic device shut-off

2,000 W

High-performance, short soldering times



Soldering without open flame

No risk of fire from flammable walls, floor coverings, plastic parts etc.

Highly flexible, extra long 4 m solder gun cable

Large working radius, also when working under ceilings

Compact design

Comfortable transport and convenient use

ROTHERM 2000 soft soldering set

Electric soft soldering unit up to Ø 54 mm / 2.1/8"

Set (No. 36702) includes: ROTHERM 2000 soft soldering unit, 230 V (No. 36700), ROSOL 3 fittings soldering paste (No. 45225), fitting solder 3 (No. 45255), ROVLIES (No. 45268), internal brushes 12 mm (No. 854181) / 15 mm (No. 854183) / 18 mm (No. 854185) / 22 mm (No. 854186) / 28 mm (No. 854187), steel case (No. 36715)

Particularly suitable for repair and modification work in surroundings or rooms with a fire hazard, as well as in building refurbishment!

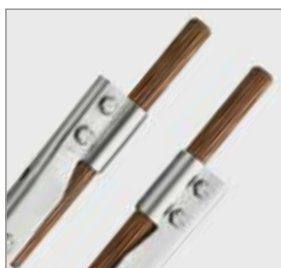
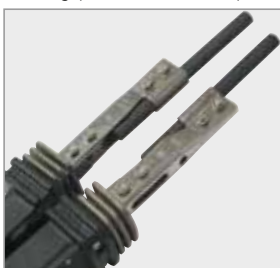


Fig. similar

Warming up of the soldering joint without open flame



Rod electrodes for working near to the wall or between parallel running pipes with narrow gaps (can be ordered separately)



Flat electrode

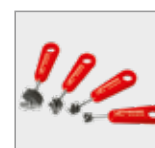
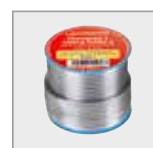



Simple replacement of electrodes and electrode holders



Model	kg	230 V 50/60 Hz
ROTHERM 2000 soft soldering set	17.8	36702
ROTHERM 2000 soft soldering unit	13.6	36700
Steel case	3.5	36715

ACCESSORIES



Model	No.	Model	
Flat electrode (pair)	36721	ROVLIES cleaning pads	173
Flat electrode with holder (pair)	36711	Fittings solder flux	175
Rod electrodes (pair)	36720	Fittings solders	175
Rod electrodes with holder (pair)	36710	Internal brushes for copper pipe	173

Bonding

Gas-welding

ALLGAS 2000 set

Mobile soldering and welding torch

Ideal mobile soldering and welding torch for plumbers, HVAC fitters, refrigeration technicians, automotive workshops and tinsmiths



Product profile

APPLICATION AREA

Soldering range:	up to 2.5 mm material thickness
Welding range:	0.2 - 5 mm
Suitable for use with:	Acetylene and oxygen Propane and oxygen CNG and oxygen Town gas and oxygen

Product profile

KEY FEATURES

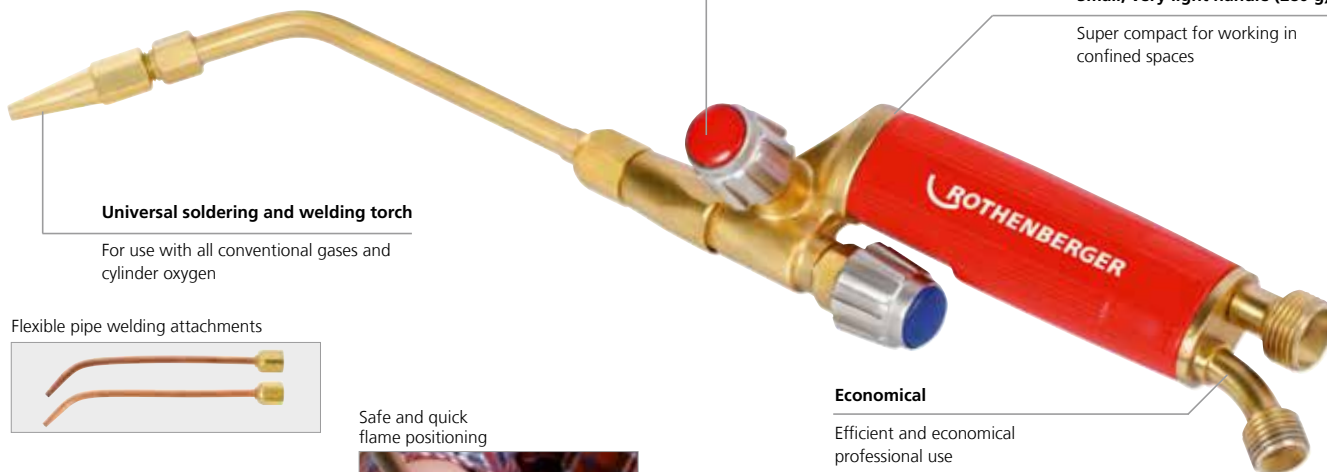
- For use with all conventional gases and cylinder oxygen
- Practically complete emptying of gas cylinders (money-saving)
- Super compact for working in confined spaces
- Efficient and economical professional use

Low gas pressure of only 0.2 bar

Practically complete emptying of gas cylinders (money saving) for use with all conventional gases and cylinder oxygen

Small, very light handle (280 g)

Super compact for working in confined spaces



Universal soldering and welding torch

For use with all conventional gases and cylinder oxygen

Flexible pipe welding attachments



Safe and quick flame positioning



Dispersion burners for warming up



Economical

Efficient and economical professional use

17-part set (No. 35300) includes: handle (No. 35303), mixing burners with union nut (No. 35304), welding tips 0.2 - 1.0 mm (No. 35305) / 1.0 - 2.0 mm (No. 35306) / 2.0 - 3.0 mm (No. 35307) / 3.0 - 4.0 mm (No. 35308) / 4.0 - 5.0 mm (No. 35309), flexible welding tips size 1 (No. 35313) / size 2 (No. 35314), coupling / union nut size 14 (No. 35315), dispersion burners (No. 35311), 2.5 m dual-hose package (No. 35221), open-ended spanner size 14 x 19 mm (No. 32073), welding tip holder / spanner (No. 35312), safety igniter (No. 32077), replacement flints (No. 32088), steel case (No. 35319)



ALLGAS 2000 set

Fig. similar

Model	Coupling oxygen	Coupling fuel gas	g	No.
ALLGAS 2000 set (acetylene)			3,100	35300
ALLGAS 2000 handle	G 1/4" RH	G 3/8" LH	280	35303
Mixing burners with union nut			40	35304

Welding tips and welding attachments

Model	Welding range mm	g	No.
Welding tip size 2	1.0 - 2.0	10	35306
Welding tip size 3	2.0 - 3.0	10	35307
Welding tip size 4	3.0 - 4.0	10	35308
Welding tip size 5	4.0 - 5.0	10	35309
Welding tip holder, can be used as a spanner		20	35312
Flexible welding tip size 1	2.0 - 3.0	40	35313
Flexible welding tip size 2	4.0 - 5.0	40	35314
Coupling / union nut size 14		10	35315

ALLGAS 2000 PS 0.5 / 2 Compact

Portable brazing equipment with carrying frame

For brazing iron, steel, sheet steel, pipes and non-ferrous metals



Product profile

KEY FEATURES

- Secure transport in closed supporting frame
- Portable, light brazing equipment
- Ideal for mobile building-site and repair use
- Small propane cylinders can be refilled

TECHNICAL DATA

Gas: Propane and oxygen
Flame temperature: 2,850 °C
Working temperature: 1,150 °C

With safety devices to prevent flashbacks

24-part set (No. 35655) includes: ALLGAS 2000 handle (No. 35303), propane hose, 2.5 m (No. 32201), oxygen hose, 2.5 m (No. 35210), propane regulator adjustable 0 - 6 bar (No. 242206000), oxygen pressure reducer 10 bar (No. 35634), mixing burners with union nut (No. 35304), welding tips 0.2 - 1.0 mm (No. 35305) / 1.0 - 2.0 mm (No. 35306) / 2.0 - 3.0 mm (No. 35307) / 3.0 - 4.0 mm (No. 35308) / 4.0 - 5.0 mm (No. 35309), flexible welding tips size 1 (No. 35313) / size 2 (No. 35314), dispersion burners (No. 35311), welding tip holder / spanner (No. 35312), multi-size spanner (No. 35738), safety igniter (No. 32077), replacement flints (No. 32088), nylon safety goggles (No. 540620), small propane cylinder 0.425 kg, empty (No. 33079), steel oxygen cylinder 2.0 l, full (No. 35635), oxygen safety device (No. 1000000633), fuel gas safety device (No. 1000000631), carrying frame (No. 35629)

Model	kg	No.
ALLGAS 2000 PS 0.5 / 2 Compact set	21.4	35655
Carrying frame without accessories	10.3	35629

Further accessories can be found on 172

Carrying comfort



Fig. similar



The bottle colors shown are without obligation!
Fig. similar

ALLGAS 2000 welding tips

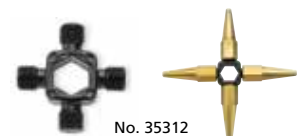
For brazing iron, steel, sheet steel, pipes and non-ferrous metals



Welding tips, thread M8 X 1



No. 35309



No. 35312

Model	Welding range mm	g	No.
Welding tip size 2	1.0 - 2.0	10	35306
Welding tip size 3	2.0 - 3.0	10	35307
Welding tip size 4	3.0 - 4.0	10	35308
Welding tip size 5	4.0 - 5.0	10	35309
Welding tip holder, can be used as a spanner	20		35312

Flexible pipe welding attachments

Model	Welding range mm	g	No.
Flexible welding tip size 1	2.0 - 3.0	40	35313
Flexible welding tip size 2	4.0 - 5.0	40	35314
Coupling / union nut size 14	10		35315



Bonding

Gas-welding

ALLGAS Mobile Pro

Mobile brazing equipment with safety devices

For brazing of iron, steel, sheet steel, pipes and non-ferrous metals



Product profile

KEY FEATURES

- Mobile brazing set with a total weight lower than 6 kg incl. cartridges
- High-quality safety devices for both gas hoses to prevent flashbacks
- MAPP[®] gas pressure regulator with an adjustable range of 0 - 2 bar for a constant, low consumption and an efficient flame adjustment

TECHNICAL DATA

Gas:	MAPP [®] gas with oxygen
Flame temperature:	over 3,100 °C
Working temperature:	1,300 °C

Accessories included in the set



7



High-quality safety devices

Reliable prevention of gas returns and flashbacks

Pressure reducer 0 - 2 bar

Constant, low consumption and efficient flame adjustment

Total weight < 6 kg

High mobility on construction site

High-quality rubber hoses

20 bar, EN ISO 3821 certified, length: 2.5 m

MAPP[®] and oxygen

Flame temperature above 3,100 °C

Welding and brazing torch

Including 5 interchangeable burners and a bendable welding attachment for a material thickness up to 5 mm

Fig. similar

Model		No.
ALLGAS Mobile Pro 1" US, w/o cartridges	3.86	1000000529
ALLGAS Mobile Pro 1" US, with cartridges	5.95	1000000743
ALLGAS Mobile Pro 7/16" EU, w/o cartridges	3.86	1000000642
ALLGAS Mobile Pro 7/16" EU, with cartridges	5.70	1000000558
MAPP [®] gas 1" US, 750 ml	12 0.9	35698
MAPP [®] gas 7/16" EU, 800 ml	12 0.9	035521-A
Oxygen steel cylinder, disposable, 950 ml, 110 bar	12 1.33	35750

Model		No.
Pressure regulator 1" US f. MAPP [®] /LPG	0.38	1000000620
Pressure regulator M10 x 1 f. oxygen	0.35	1000000629

ALLGAS 2000 PS 0.5 / 2 Basic

Portable fitter's brazing equipment

For brazing iron, steel, sheet steel, pipes and non-ferrous metals



KEY FEATURES

- Compact and handy construction for mobile building-site and repair use
- Job compatible combination, assembled and ready to use



The bottle colors shown are without obligation!
Fig. similar

Space saving storage
in service vehicles!



18-part set (No. 35651) includes: ALLGAS 2000 handle (No. 35303), propane hose, 2.5 m (No. 32201), oxygen hose, 2.5 m (No. 35210), propane regulator adjustable 0 - 6 bar (No. 242206000), oxygen pressure reducer 10 bar (No. 35634), mixing burners with union nut (No. 35304), welding tips 0.2 - 1.0 mm (No. 35305) / 1.0 - 2.0 mm (No. 35306) / 2.0 - 3.0 mm (No. 35307) / 3.0 - 4.0 mm (No. 35308) / 4.0 - 5.0 mm (No. 35309), welding tip holder / spanner (No. 35312) multi-size spanner (No. 35738), safety igniter (No. 32077), replacement flints (No. 32088), steel oxygen cylinder 2.0 l, filled (No. 35635), propane cylinder 0.5 kg, empty (No. 33079), ALLGAS stand (No. 35628)

Model	kg	No.
ALLGAS 2000 PS 0.5 / 2 Basic set	14.4	35651
Further accessories can be found on 172		

ROXY 400 L

Standard gas-welding equipment for flame temperatures up to 3,100 °C

For brazing iron, steel, sheet steel, pipes and non-ferrous metals



Space saving storage
in service vehicles!



The bottle colors shown are without obligation!
Fig. similar



19-part set (No. 035780X) includes: handle with fine regulating valve (No. 35580), Maxigas 400 (No. 035570-A), oxygen cylinder 2.0 L (No. 35635), fine regulating valve (No. 263003700), oxygen pressure reducer according to DIN 0-315 / 200 bar 0-16 / 10 bar (No. 35634), hose set, 3 m without handle (No. 35785), oxygen blowback protection (No. 1000000633), gas blowback protection (No. 35691), mixing burners with union nut (No. 35587), high-performance tips 1.5 mm (No. 263005600) / 2.0 mm (No. 263005400), micro-tips 0.3 mm (No. 35712) / 0.5 mm (No. 35696) / 0.7 mm (No. 35713), micro-tip adaptor (No. 35585), welding goggles A5 (No. 35621), safety igniter (No. 32077), multi-size spanner (No. 35738), carrying frame (No. 35727)

Model	kg	No.
ROXY 400 L, complete	10.80	035780X
ROXY 400 L without oxygen	6.0	35782
Welding-handle, M14x1	0.12	35580
Dual hose set 3 m	0.95	35785
Micro-tip adaptor	0.01	35585
Micro-tip 0.4 mm	0.01	35695
Micro-tip 0.5 mm	0.02	35696
Micro-tip 0.6 mm	0.02	35697
Micro-tip 0.7 mm	0.02	35713
High-performance tip 0.7 mm	0.06	263005800
High-performance tip 1.2 mm	0.04	263005700
High-performance tip 1.5 mm	0.04	263005600
High-performance tip 2.0 mm	0.04	263005400

Bonding

Three-gas welding

RE 17 three-gas system AMS 5/5

Assembly, welding, cutting and brazing system
Welding range: 0.5 - 14 mm, Cutting range: 12 - 50 mm



Including gas cylinders and dual-telescoping transport trolley!

The bottle colors shown are without obligation! Fig. similar

27-part set (No. 35400) includes: handle with coupling nut (No. 35324), welding attachments 0.5 - 1.0 mm (No. 35325) / 1.0 - 2.0 mm (No. 35326) / 2.0 - 4.0 mm (No. 35327) / 4.0 - 6.0 mm (No. 35328) / 6.0 - 9.0 mm (No. 35329) / 9.0 - 14.0 mm (No. 35334), wing-lever cutting attachment (No. 35338), cutting tips 12 - 25 mm (No. 35341) / 25 - 50 mm (No. 35344), heating burners 12-100 mm (No. 35339), dual hoses A/O, 5m (No. 35222), acetylene pressure reducer 1.5 bar (No. 35794), oxygen pressure reducer 10 bar (No. 35634), 2x red (No. 511428) / 2x blue protective rubber caps (No. 511427), 10 piece burners cleaning set (No. 510105), torch spanner (No. 510106), safety igniter (No. 32077), replacement flints (No. 32088), acetylene cylinder 5 l, filled (No. 35178), oxygen cylinder 5 l, filled (No. 35188), Maxigas 400 (No. 035570-A), gas regulating valve Maxigas (No. 1300003161), hose adaptor Maxigas (No. 35491), steel case (No. 35800), dual-telescoping transport trolley (No. 35354),

Model	kg	No.
RE 17 three-gas system AMS 5/5	50	35400

RE 17 three-gas system AMS 5 and 10

Assembly, welding, cutting and brazing system
Welding range: 0.5 - 14 mm, Cutting range: 12 - 50 mm



7



Including dual-telescoping transport trolley!

The bottle colors shown are without obligation! Fig. similar

24-part set (No. 35403) includes: handle with coupling nut (No. 35324), welding attachments 0.5 - 1.0 mm (No. 35325) / 1.0 - 2.0 mm (No. 35326) / 2.0 - 4.0 mm (No. 35327) / 4.0 - 6.0 mm (No. 35328) / 6.0 - 9.0 mm (No. 35329) / 9.0 - 14.0 mm (No. 35334), wing-lever cutting attachment (No. 35338), cutting tips 12 - 25 mm (No. 35341) / 25 - 50 mm (No. 35344), heating burners 12 - 100 mm (No. 35339), dual hoses A/O, 5 m (No. 35222), acetylene pressure reducer 1.5 bar (No. 35794), oxygen pressure reducer 10 bar (No. 35634), 2x red (No. 511428) / 2x blue protective rubber caps (No. 511427), 10 piece burners cleaning set (No. 510105), torch spanner (No. 510106), safety igniter (No. 32077), replacement flints (No. 32088), gas regulating valve Maxigas (No. 1300003161), hose adaptor Maxigas (No. 35491), steel case (No. 35800), dual-telescoping transport trolley (No. 35354)

Model	kg	No.
RE 17 three-gas system AMS 5 + 10	23	35403

RE 17 three-gas system AMS 10/10

Assembly, welding, cutting and brazing system
Welding range: 0.5 - 14 mm, Cutting range: 12 - 50 mm



Including gas cylinders and dual-telescoping transport trolley!

The bottle colors shown are without obligation! Fig. similar

27-part set (No. 35401) includes: handle with coupling nut (No. 35324), welding attachments 0.5 - 1.0 mm (No. 35325) / 1.0 - 2.0 mm (No. 35326) / 2.0 - 4.0 mm (No. 35327) / 4.0 - 6.0 mm (No. 35328) / 6.0 - 9.0 mm (No. 35329) / 9.0 - 14.0 mm (No. 35334), wing-lever cutting attachment (No. 35338), cutting tips 12 - 25 mm (No. 35341) / 25 - 50 mm (No. 35344), heating burners 12 - 100 mm (No. 35339), dual hoses A/O, 5 m (No. 35222), acetylene pressure reducer 1.5 bar (No. 35794), oxygen pressure reducer 10 bar (No. 35634), 2x red (No. 511428) / 2x blue protective rubber caps (No. 511427), 10 piece burners cleaning set (No. 510105), torch spanner (No. 510106), safety igniter (No. 32077), replacement flints (No. 32088), acetylene cylinder 10 l, filled (No. 35179), oxygen cylinder 10 l, filled (No. 35189), Maxigas 400 (No. 035570-A), gas regulating valve Maxigas (No. 1300003161), hose adaptor Maxigas (No. 35491), steel case (No. 35800), dual-telescoping transport trolley (No. 35354)

Model	kg	No.
RE 17 three-gas system AMS 10/10	66	35401



RE 17 UNIVERSAL pipe welding set

For welding, cutting, brazing and warming up
Welding range: 0.5 - 14 mm, Cutting range: 12 - 100 mm

Set (No. 35479) includes: handle with coupling nut (No. 35324), welding attachments 2.0 - 4.0 mm (No. 35327) / 4.0 - 6.0 mm (No. 35328) / 6.0 - 9.0 mm (No. 35329), flexible pipe-welding tips 2.0 - 4.0 mm (No. 35347) / 4.0 - 6.0 mm (No. 35348), wing-lever cutting attachment (No. 35338), cutting tip 12 - 25 mm (No. 35341), heating burners 12 - 100 mm (No. 35339), nozzle cleaning set, 10 piece (No. 510105), torch spanner (No. 510106), safety igniter (No. 32077), replacement flints (No. 32088), steel case (No. 35800)

Model	kg	No.
RE 17 pipe welding set	4.3	35479
RE 17 pipe welding set as in set (No. 35479), but also including with welding attachments 0.5 - 1.0 mm (No. 35325) / 1 - 2 mm (No. 35326), cutting tip 12 - 25 mm (No. 35341) / 25 - 50 mm (No. 35344)	4.8	35480
Steel case RE 17 (empty)	1.70	35800
RE 17 handle with burner coupling nut	0.47	35324
Coupling: oxygen G 1/4" RH, gas G 3/8" LH		



No. 35480

Fig. similar



No. 35324

RE 17 welding attachments

	Welding range mm	g	No.
Welding attachment	0.5 - 1.0	140	35325
Welding attachment	1.0 - 2.0	150	35326
Welding attachment	2.0 - 4.0	170	35327
Welding attachment	4.0 - 6.0	190	35328
Welding attachment	6.0 - 9.0	220	35329
Welding attachment	9.0 - 14.0	260	35334



7

RE 17 welding attachments, bendable

Pipe welding attachment, complete

Flexible copper tips

Welding range mm	g	No.	Welding range mm	g	No.
2.0 - 4.0	140	35347	1.0 - 2.0	40	35475
4.0 - 6.0	150	35348	2.0 - 4.0	40	35476
			4.0 - 6.0	50	35477

Pipe welding attachment, front piece



Pipe welding attachment, complete



RE 17 wing-lever cutting attachment

Model	g	No.
Cutting attachment without tips	820	35338

RE 17 cutting tips and heating burners

Model	Cutting range mm	g	No.
Cutting tip	12 - 25	10	35341
Cutting tip	25 - 50	20	35344
Cutting tip	50 - 100	20	35345
Heating burners	12 - 100	50	35339



No. 35338

No. 35341
No. 35344
No. 35345

No. 35339

Bonding

Accessories soldering & welding

Oxy-acetylene hoses

Top quality in accordance with **ISO 3821** (former EN 559), with strong inlay, durable and flexible, rubber, mounted with sleeves and nuts



Oxygen hoses

L m	Inlet	Outlet	Internal Ø x Wall thickness	kg	No.
2.5	G 1/4" RH	G 1/4" RH	4 x 3.5	0.5	35210
5.0	G 1/4" RH	G 1/4" RH	4 x 3.5	1.1	33311

Dual hoses A/O

L m	Inlet/Outlet Oxygen	Inlet/Outlet Acetylene	Interior Ø x Wall thickness	kg	No.
2.5	G 1/4" RH	G 3/8" LH	6.3 x 3.5	0.9	35221
5.0	G 1/4" RH	G 3/8" LH	6.3 x 3.5	2.0	35222
10	G 1/4" RH	G 3/8" LH	6.3 x 3.5	3.8	35223



7

Lightweight steel cylinders, filled

With cylinder valve and cap (5 l and 10 l), TÜV tested in accordance with TRGI



Protective bracket included in delivery for steel cylinders without cap,



The bottle colors shown are without obligation! Fig. similar

Model	Contents	Filling pressure bar	Height mm	Ø mm	kg	No.
Oxygen	950 ml	110	340	70	1.33	35750
Oxygen	2 l	200	420	110	4.6	35635
Oxygen	5 l	200	595	145	14.0	35188
Oxygen	10 l	200	980	145	17.0	35189
Acetylene	5 l	18	595	145	13.0	35178
Acetylene	10 l	18	980	145	23.0	35179

Cylinder transport trolley


Portable and mobile, for 5 and 10 l acetylene / oxygen cylinders, 5 kg and 12 kg propane cylinders can be used with conversion kit (special accessory). Coupling for disposable Maxigas 400 cartridges, dual-telescoping for different cylinder heights, brackets for ALLGAS and RE 17 steel cases

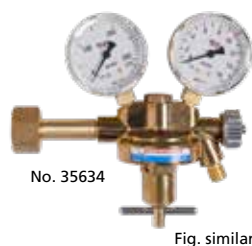


Model	kg	No.
Transport trolley for 5 / 10 l acetylene / oxygen cylinders	8.9	35354

Cylinder pressure reducer


Robust pressed brass construction according to EN ISO 2503 with large pressure gauge according to ISO 5171, with shut-off and safety valves. Acetylene cylinder pressure reducer with bow coupling according to DIN 477-1

Cylinder contents bar	Working pressure bar	Inlet	Outlet		No.
Oxygen 0 - 200	0 - 10	G 3/4" RH	G 1/4" RH	1.4	35634
Acetylene 0 - 40	0 - 1.5	Bow	G 3/8" LH	1.6	35794



Blowback prevention


Safety devices (flashback arrestors) according to EN 730-1 and ISO 5175-1, type tested, with flame arrestor (FA) and non-return valve (NV). No. 540360 and No. 540365 are additionally equipped with a temperature-sensitive cut-off valve (TV) and filter

Model	max. working pressure	Coupling		No.
Handle-mounted, oxygen	25.0 bar	G 1/4" RH	150	540360
Handle-mounted, acetylene	1.5 bar (ace)	G 3/8" LH	160	540365
	5.0 bar (propane/CNG)			
Reducer-mounted, oxygen	25.0 bar	G 1/4" RH	120	100000633
Handle, oxygen	20.0 bar	G 1/4" RH	100	100000764
Handle, fuel gas	1.5 bar (ace)	G 3/8" LH	100	100000762
	4.0 bar (propane/CNG)			



Protective rubber cap


With slot, open

Model	Color		No.
For oxygen pressure reducer	blue	50	511427
For acetylene pressure reducer	yellow	50	511428



Oxygen refilling bend


Suitable for all 0.67l, 2l, 3l, 5l, 10l, 20l and 50l bottles up to 200bar

Model		No.
max. 200 bar, cylinder coupling G 3/4"	360	35199



Safety igniters

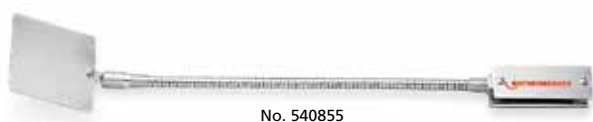
Powerful spark, wear-free hard alloy friction surface

Model		No.
Safety igniter	60	32077
Replacement flints, tin, 5 pcs.	15	32088



Bonding

Accessories soldering & welding



Magnet welding mirror

Model	g	No.
With flexible metal tube / ball joint	450	540855
Spare steel mirror	50	540851



Burners cleaner

Model	g	No.
Burners cleaner, in folding case, 11 pcs.	20	510105



Torch spanner

Model	g	No.
With 10 wrench sizes	210	510106



Soldering flux and container for hydrochloric acid

Model	g	No.
With screw cap retaining band for 150 ml content	40	530250



Welding goggles EN 166

With thermal glasses **as per EN 169**


Model	Glas	g	No.
Nylon safety goggles	A 4	60	540620
	A 5	60	540621
Replacement glass (pair)	clear, non-splintering	60	540622
	A 4	30	540625
Screw-ring safety goggles	A 5	10	540626
	clear, non-splintering	30	540627
Replacement glass (Ø 50 mm)	A 4	90	540640
	A 4	30	540675

ROVLIES cleaning pads

Metal-free, for fast, score-free cleaning of copper pipe soldering surfaces

KEY FEATURES

- Reduced corrosion damage
- No metal abrasion, can be used wet or dry
- Removes oxide layers, corrosion, surface dirt, oil and grease residues
- Solvent-resistant and flexible

Model		No.
ROVLIES (10 pcs.)	80	45268
ROVLIES counter display (36 pcs.)	2,180	045268D



Internal brushes for copper pipe

For fast cleaning of the soldering surface with rugged plastic handle






		No.			No.
mm	g		mm	g	
12	80	854181	22	140	854186
15	100	854183	28	140	854187
18	120	854185			



Fig. similar

Hand wire brushes

Model	Number of rows		No.
Standard steel	3 rows	130	561351




Welding blanket

Flame and heat resistant up to 840 °C

- Permanent heat resistance up to 700 °C by direct flame contact and molten slag
- Good formability, long service life, asbestos-free and poses no health hazard
- Bonded edges

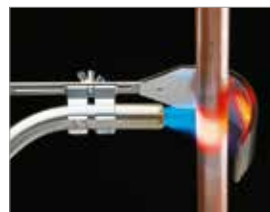
Thickness: 2.8 mm
Weight: 1,600 g/m²




Model	L x W x H		No.
Welding blanket	500 x 330 x 3 mm	300	31050

Flame reflectors

- Made of high-quality stainless steel
- Protects surrounding materials
- Better heat utilisation, saves time and energy



Model	Width mm	Adaptor Ø mm		No.
65 / 15	65	8 – 15	100	31042
65 / 22	65	15 – 22	100	31043

Bonding

Accessories soldering & welding

Fitting soft solder according to EN standard





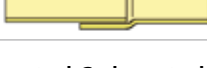
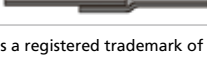
Standard type according to EN 9453	Solder composition in weight %	Melting range °C	Suitable for soft soldering in the plumbing industry			Recommended heat source
			Pipe material	Fittings material	Recommended flux according to EN 9454-1	
S-Sn97Cu3	Sn 97, Cu 3	230 - 250	Copper	Copper, gunmetal, brass	Part 1 - 3.1.1, 3.1.2, 2.1.2 or ROSOL 3	Cartridge burner, heat resistant soldering unit, propane / induced-air burner, acetylene / induced-air burner, larger pipe diameters above 28 mm with propane / oxygen burner with dispersion burners
S-Sn97Ag3	Sn 96.7, Ag 3.3	221 - 240	Copper	Copper, gunmetal, brass	Part 1 - 3.1.1, 3.1.2, 2.1.2 or ROSOL 1 S	

Standard solder according to EN ISO standard

Standard type according to ISO 17672	Solder composition in weight %	Melting range °C	Working temperature °C	Suitable for installation technology brazing			Recommended flux according to EN 1045	Recommended heat source
				Pipe material	Fittings material	Flux		
CuP 179	Cu 94 / P 6	710 - 890	760	Copper	Copper Gunmetal Brass	without flux with flux	FH 10 or LP 5	Cartridge torch with MAPP ¹⁾ gas, Propane / induced-air torch, Acetylene / induced-air torch, Larger pipe diameters above 28 mm with propane / oxygen torch with dispersion burners
CuP 279	Ag 2 / Cu 91,8 / P 6,2	645 - 825	740	Copper	Copper Gunmetal Brass	without flux with flux	FH 10 or LP 5	
CuP 281	Ag 5 / Cu 89 / P 6	645 - 815	710	Copper	Copper Gunmetal Brass	without flux with flux	FH 10 or LP 5	
CuP 284	Ag 15 / Cu 80 / P 5	645 - 800	700	Copper	Copper Gunmetal Brass	without flux with flux	FH 10 or LP 5	
Ag 134	Ag 34 / Cu 36 / Zn 27,5 / Sn 2,5	630 - 730	710	Steel Copper	Steel, Copper Gunmetal Brass	with flux (U = sheathed from 22 mm pipe-Ø)	FH 10 or LP 5	
Ag 145	Ag 45 / Cu 27 / Zn 25,5 / Sn 2,5	640 - 680	670	Steel Copper	Steel, Copper Gunmetal Brass	with flux (U = sheathed from 22 mm pipe-Ø)	FH 10 or LP 5	

7

Soldered joints

Material	Required hard solder	Melting range	Working temperature	Standard
Copper-Copper 	S 34 Cu / S 34 Cu U S 94 S 2 S 5 S 15	630 °C - 730 °C 710 °C - 890 °C 645 °C - 825 °C 645 °C - 815 °C 645 °C - 800 °C	710 °C 760 °C 740 °C 710 °C 700 °C	EN ISO 17672 (former DIN EN 1044)
Copper-Carbon steel 	S 34 Cu / S 34 Cu U S 45 Cu / S 45 Cu U	630 °C - 730 °C 640 °C - 680 °C	710 °C 670 °C	EN ISO 17672 (former DIN EN 1044)
Copper-Brass 	S 94 S 2 S 5 S 15	710 °C - 890 °C 645 °C - 825 °C 645 °C - 815 °C 645 °C - 800 °C	760 °C 740 °C 710 °C 700 °C	EN ISO 17672 (former DIN EN 1044)
Brass-Carbon steel 	S 34 Cu / S 34 Cu U S 45 Cu / S 45 Cu U	600 °C - 690 °C 595 °C - 630 °C	680 °C 610 °C	EN ISO 17672 (former DIN EN 1044)
Brass-Brass 	S 94 S 2 S 5 S 15	710 °C - 890 °C 645 °C - 825 °C 645 °C - 815 °C 645 °C - 800 °C	760 °C 740 °C 710 °C 700 °C	EN ISO 17672 (former DIN EN 1044)
Carbon steel-Carbon steel 	S 34 Cu / S 34 Cu U S 45 Cu / S 45 Cu U	630 °C - 730 °C 640 °C - 680 °C	710 °C 670 °C	EN ISO 17672 (former DIN EN 1044)


¹⁾ MAPP is a registered trademark of the MESSER Group GmbH, Bad Soden

Fittings solders

Quality soft solders according to **EN 9453** for joining copper pipes to copper, gunmetal and brass fittings for hot and cold-water plumbing in accordance with DVGW worksheet GW 2 without flux, for use with corresponding ROSOL fittings solder paste

Fitting solder 1 S

Quality soft solder **S-Sn97Ag3**, melting range 221 °C - 240 °C, for use with ROSOL 1 S fittings solder paste


Solder wire Ø	Description	 g	No.
2 mm	250 g coil	270	45252
3 mm	250 g coil	270	45250



No. 45252

Fitting solder 3

Quality soft solder, **S-Sn97Cu3**, melting range 230 °C - 250 °C, for use with ROSOL 3 fittings solder paste

Solder wire Ø	Description	 g	No.
2 mm	250 g coil	270	45257
3 mm	250 g coil	270	45255



No. 45257


ROSOL soldering paste

Quality soft soldering flux according to **EN ISO 9453** and **EN 29454-1, 3.1.1.C, with DVGW test mark Reg.-No. DV-0101AT2247**, for joining copper pipes to copper, gunmetal and brass fittings for hot and cold-water plumbing in accordance with DVGW worksheet GW 7, metal content 60% by weight, flux residues are 100% water soluble

ROSOL 1 S

Fittings solder paste

Quality soft soldering flux, metal content: **S-Sn97Ag3**, only for use with fitting solder 1 S

Model	 g	No.
ROSOL 1 S in plastic bottle 250 g	270	45220



No. 45220




No. 45225

ROSOL 3


Fittings solder paste

Quality soft soldering flux, metal content: **S-Sn97Cu3**, only for use with fittings solder 3

Model	 g	No.
ROSOL 3 in plastic bottle 250 g	270	45225

Fittings soft solder flux

According to **EN ISO 9454-1-3114**, flux residues are 100 % water soluble, for joining copper pipes to copper, gunmetal, and brass fittings for hot and cold-water plumbing in accordance with DVGW worksheet GW 2 and GW 7, also suitable for general-purpose soldering work.

Model	 g	No.
Fittings soft solder flux in plastic jar 35 ml	35	45266



Bonding

Accessories soldering & welding



Hard solder rings S 2

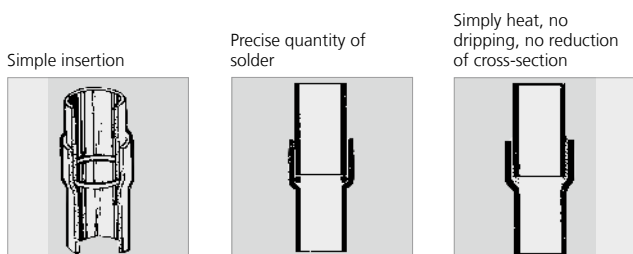
High-quality safety solder material with silver-phosphorus content, guaranteed according to EN ISO 17672, CuP 279

KEY FEATURES

- Ideal for capillary soldering with copper pipe installation in sanitary and heating systems
- Matched precisely to the inner pipe diameters of expanded sockets and fittings according to EN 1254
- Complete wetting of soldering gaps
- Particularly efficient working through precise solder quantity
- No preparatory or rework of the soldered joint

TECHNICAL DATA

Alloy (weight %): Ag 1.5 - 2.5 / P 5.9 - 6.5 / Cu rest
Melting range: 650 °C - 810 °C
Joinable materials: Copper, gunmetal, brass, bronze
Use of flux with: Gunmetal, brass, bronze with hard solder paste LP 5
Package size: 250 g plastic bag



Model	approx. Content rings	g	No.
Hard solder rings S 2, Ø 14 mm	268 pcs.	260	40514
Hard solder rings S 2, Ø 15 mm	244 pcs.	260	40515
Hard solder rings S 2, Ø 28 mm	79 pcs.	260	40528

Hard solder paste LP 5

Flux for hard soldering at working temperatures above 600 °C, according to EN 1045, type FH 10, DVGW tested Reg.-No. DV-0101-AT2245, for gas and water installations with copper pipes, recommended by DVGW in accordance with worksheets GW 2 and GW 7, hard solders with silver content and usable with any basic materials of steel, copper and copper alloys, brass and gunmetal, working temperature range 500 °C - 800 °C, flux residues must be removed carefully



Model	Content	g	No.
LP 5 in plastic bottle	160 g	180	40500

Hard solder powder HKM

Flux for hard soldering at working temperatures above 800 °C, according EN 1045 - FH 21, working temperature 800 °C - 1,100 °C, for copper and copper alloys, brass, gunmetal, nickel silver, bronze, steel and galvanised steel, grey iron and malleable cast iron, for welding copper and brass in dry conditions, can be mixed with clean water to form a paste, flux residues must be removed carefully. Free of boric acid.



Model	Content	g	No.
HKM in plastic bottle	50 g	65	35611

Hard solders

For copper pipe installation

ROTHENBERGER ROLOT special hard solders are particularly suited for copper pipe installations in cold and hot water systems, for open and closed heating systems, for gas installations in accordance with DVGW Worksheet GW 2 (liquid, natural and town gas) as well as for HVAC and refrigeration applications, and oil pipes. ROTHENBERGER ROLOT is especially suited for capillary soldering of copper pipes without fittings. Copper / phosphorus / silver solders are highly formable, and are therefore recommended for joints that are subjected to high thermal and mechanical alternating loads.

KEY FEATURES

- Non-foaming
- Heat-resistant up to 200 °C
- No flux required with copper / copper joints (except S34 and S45)
- Manufactured with new, environmentally compatible technology, corrosion neutral, scale-free, improved flow properties



ROLOT S 94 CuP 179

Quality hard solder **guaranteed according to EN ISO 17672**, due to low phosphorus content, the solder has a wide melting range, and creates soldered joints with increased strength. Standard solder for normally-stressed copper pipe installation, especially for capillary soldering with copper pipe installation without fittings

TECHNICAL DATA

Alloy (weight %):	Cu 94 / P6
Melting range:	710 - 890 °C
Working temperature:	760 °C
Joinable materials:	Copper, gunmetal, brass, bronze
Flux required with:	Gunmetal, brass, bronze with LP 5



Content	Squared section mm	Length mm	g	No.
1 kg carton	2 x 2	500	1,025	40094

ROLOT S 2

Special quality hard solder, not standardised, **similar to EN ISO 17672**, with low silver content, matched to normally-stressed copper pipe system, ideal for capillary gap soldering

TECHNICAL DATA

Melting range:	700 - 850 °C
Working temperature:	750 °C
Joinable materials:	Copper, gunmetal, brass, bronze
Flux required with:	Gunmetal, brass, bronze with hard solder paste LP 5



Content	Square section mm	Length mm	g	No.
1 kg carton	2 x 2	500	1,025	40202

ROLOT S 2 CuP 279

Silver / phosphorus safety hard solder, **guaranteed according to EN ISO 17672**, for higher-stressed copper pipe systems, ideal for capillary soldering in sanitary, heating and gas installations

TECHNICAL DATA

Alloy (weight %):	Ag 2 / Cu 91,8 / P 6,2
Melting range:	645 - 825 °C
Working temperature:	710 °C
Joinable materials:	Copper, gunmetal, brass, bronze
Flux required with:	Gunmetal, brass, bronze with hard solder paste LP5



Content	Square section mm	Length mm	g	No.
1 kg carton	2 x 2	500	1,025	40212
1 kg carton	3 x 3	500	1,025	40213


Bonding

Accessories soldering & welding



ROLOT S 5

Particularly high-quality hard solder, not standardised, **similar to EN ISO 17672**, with low silver content, ideal for capillary and joint soldering in sanitary, heating and gas installations

Content	Square section mm	Length mm	 g	No.
1 kg carton	2 x 2	500	1,025	40502


TECHNICAL DATA

Melting range: 710 - 840 °C
Working temperature: 750 °C
Joinable materials: Copper, gunmetal, brass, bronze
Flux required with: Gunmetal, brass, bronze with hard solder paste LP5



ROLOT S 5 CuP 281

High-quality silver/phosphorus safety hard solder, **guaranteed according to EN ISO 17672**, for higher-stressed copper pipe systems, ideal for capillary and joint soldering in sanitary, heating and gas installations

Content	Square section mm	Length mm	 g	No.
1 kg carton	2 x 2	500	1,025	40005


TECHNICAL DATA

Alloy (weight %): Ag 5 / Cu 89 / P 6
Melting range: 645 - 815 °C
Working temperature: 710 °C
Joinable materials: Copper, gunmetal, brass, bronze
Flux required with: Gunmetal, brass, bronze with hard solder paste LP5



ROLOT S 15 CuP 284

Particularly high-quality silver hard solder, **guaranteed according to EN ISO 17672**, especially for capillary-gap soldering subject to high thermal and mechanical alternating loads in HVAC systems as well as demanding sanitary and gas installations

Content	Square section mm	Length mm	 g	No.
1 kg carton	2 x 2	500	1,025	40015

TECHNICAL DATA

Alloy (weight %): Ag 15 / CU 80 / P 5
Melting range: 645 - 800 °C
Working temperature: 710 °C
Joinable materials: Copper, gunmetal, brass, bronze
Flux required with: Gunmetal, brass, bronze with hard solder paste LP5



Silver hard solders Ag 134 S 34 Cu U flux-covered

Free of cadmium, quality silver hard solder **guaranteed according to EN ISO 17672**, flux-covered **according to EN1045 FH 10**, universal application areas for gap soldering, also for drinking water installations, heat-resistant up to 200 °C

TECHNICAL DATA

Alloy (weight %): Ag 34 / Cu 36 / Zn 27.5 / Sn 2.5
Melting range: 630 °C - 730 °C
Working temperature: 710 °C
Joinable materials: Steel, malleable cast iron, copper, gunmetal, copper and nickel alloys



Content	 mm	 g	S 34 U No.
100 g plastic bag	2	110	44915
250 g plastic bag	2	260	44916
1000 g plastic bag	2	1,010	44917



Silver hard solders Ag 145 S 45 Cu / S 45 Cu U flux-covered

Free of cadmium, quality silver hard solder, **guaranteed according to EN ISO 17672**, flux-covered **according to EN 1045, Type FH 10**, universal application areas for gap soldering, excluding drinking water installations, heat-resistant up to 200 °C

TECHNICAL DATA

Alloy (weight %): Ag 45 / Cu 27 / Zn 25.5 - 3.5 / Sn 2.5
Melting range: 640 °C - 680 °C
Working temperature: 670 °C
Joinable materials: Steel, malleable cast iron, copper, gunmetal, copper and nickel alloys, stainless steel



Content	 mm	 g	S 45 U No.
100 g plastic bag	2	110	45055
250 g plastic bag	2	260	45056





Testing and leak detection

System overview	184
Testing of water lines and containers	
Testing pumps	185 - 187
Testing of gas and water lines	
Digital testing device	188 - 189
Analogue testing device	190
Accessories testing devices	191
Leak detection	
Leak detection on water lines	192
Leak detection on gas lines	193
Leak detection spray on gas lines	193

Testing and leak detection

System overview

Precision testing pumps manual

RP 50-S / RP 50-S INOX



TP 25



RP 30



Testing and pressure range:	0 - 60 bar	0 - 25 bar	0 - 30 bar
Hub suction capacity:	45 ml / stroke	16 ml / stroke	16 ml / stroke
Tank capacity:	12 l	7 l	4.5 l
Connection:	R1/2"	R1/2"	R1/2"
Dimension:	495 x 165 x 255 mm	380 x 215 x 156 mm	440 x 200 x 240 mm
Weight:	8 kg	4.6 kg	4.5 kg
Material:	DURAMANT coated steel	DURAMANT coated steel	ABS plastic
Valve:	Twin-valve	Twin-valve	–
Pressure gauge units:	bar, psi, Mpa	bar, psi	bar, psi
Suitable for:	Oil, water and glycol	Oil, water and glycol	Oil, water and glycol
Page	185	187	187

8

Testing pumps electric

RP PRO III



Analogue / digital testing device for gas and water connections

ROTEST GW 150/4



ROTEST GW Digital V3



Testing and pressure range:	0 - 40 bar	Pressure range:	0 - 180 mbar	0 - 1,000 mbar
Flow rate:	6 l / min.	Low pressure sensor	(resolution 0.1 mbar)	(resolution 0.1 mbar)
Tank capacity:	–	Pressure range:	0 - 4 bar	0 - 20 bar
Connection:	R1/2"	High pressure sensor	(resolution 0.1 bar)	(resolution 0.01 bar)
Dimensions:	375 x 290 x 300 mm	Leak rate measurement:	–	0 - 12 L/h
Weight:	16 kg	Display resolution:	–	480 x 272
Material:	ABS plastic	Data transfer:	–	WLAN, USB
Valve:	Single valve	Battery life time:	–	Approx. 8 h testing time
Pressure gauge units:	bar, psi, Mpa	Safety class:	–	IP40
Gauge characteristics:	Glycerine cushioned	Weight:	7.3 kg	5.25 kg
Suitable for:	Oil, water and glycol			
Page	186	Page	190	188

Testing and leak detection

Testing of water lines and containers

RP 50-S / RP 50-S INOX

Robust precision testing pump for pressure testing of water lines and containers up to 60 bar with very high testing standards

Adjustment of the pressure gauge with 0.1 bar scaling is possible!



Product profile

APPLICATION AREA

Pressure testing with water or oil of piping in residential and industrial construction, as well as for industrial containers (up to 60 bar). Expansion possible with an extra fine scaling pressure gauge (0.1 bar) for testing up to 16 bars

KEY FEATURES

- A drag indicator displays the preset pressure so that a loss of pressure in the system can be detected easier
- Reliable and precise testing results: the dual-valve system (Twin Valve) enables self-testing of the pump as well as a precise fine adjustment of the pressure
- Especially precise reading as needed: finely scaled (scaling 0.1 bar) pressure gauge available separately
- Testing hose with steel mesh prevents reading mistakes, that can happen when the hose expands during operation
- Type 50-S: Weather and cold-resistant steel container with DURAMANT coating
- Type 50-S INOX: high-quality corrosion resistant stainless steel tank

TECHNICAL DATA

Testing and pressure range: 0 - 60 bar, with 1 bar steps
0 - 860 psi, with 20 psi steps
0 - 6 MPa, with 0.1 MPa steps

Hub suction capacity: approx. 45 ml / stroke

Tank capacity: 12 l

Dimensions (L x W x H): 495 x 165 x 255 mm

Connection: R 1/2"

Container RP 50-S: Steel, DURAMANT coated

Container RP 50-S INOX: Stainless steel

Warp-resistant and lockable lever

Ergonomic handle serves as carrying grip too

Additional pressure gauge with fine scaling 0.1 bar optional

Enables very precise readings up to a range of 16 bar (No. 61316)

Hook to fix the handle

Improved carrying comfort

Testing hose with steel mesh

Precise measurement

5 year warranty against corrosion

Extrem durable DURAMANT coating

TWIN VALVE-System

Two valves for double safety while testing the system

INOX



No. 60203



No. 60200

Double valve system: enables self-testing of the pump, as well as a precise fine adjustment of the pressure

Optional: Extra fine scaling Pressure gauge for the testing of systems up to 16 bar with a 0.1 scaling



Model	kg		No.
RP 50-S testing pump	8	1	60200
RP 50-S INOX (stainless steel) testing pump	8	1	60203

ACCESSORIES

Model	g	No.	Model	g	No.
Maintenance package	100	60201	High pressure hose with 1/4" connection	490	R6112500
Double nipple 1/2" to 3/4"	100	60999	Extra 16 bar pressure gauge	100	61316

¹⁾ Complete terms and conditions at rothenberger.com/roservice
RO SERVICE+ only valid in participating countries

Testing and leak detection

Testing of water lines and containers

RP PRO III

Self-priming electric testing pump up to 40 bar



Product profile

APPLICATION AREA

Electrical testing pump for the automatic pressure testing of piping and containers up to 40 bar in accordance with national and international standards

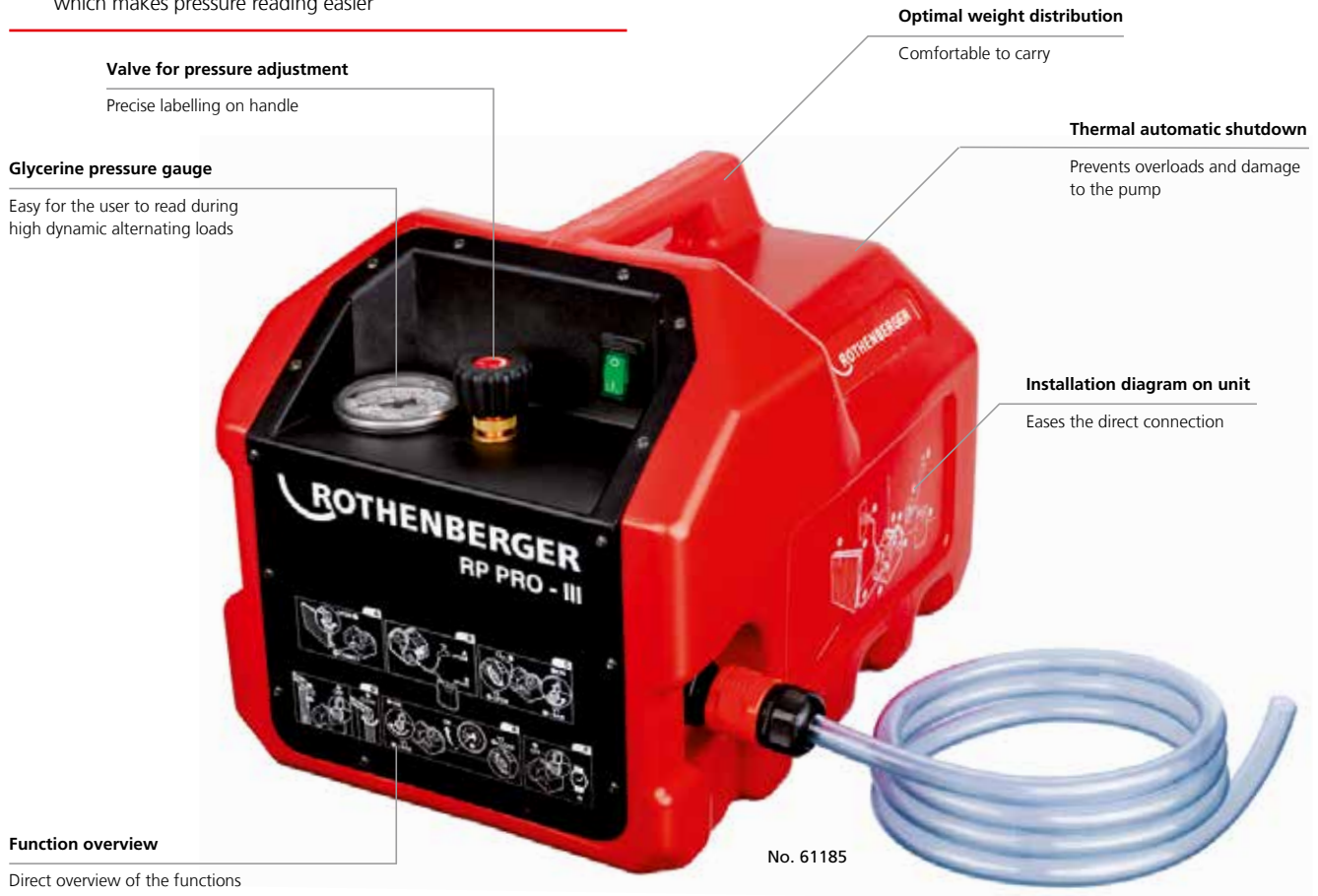
KEY FEATURES

- Comfortable, automatic filling and pressure testing of piping and containers
- Compact and robust plastic casing for simple handling at the building site
- Liquid supply freely selectable: optional self-priming up to a maximum of 1 m or from a pressure source. Suitable for oil, water and glycol
- Testing hose with steel mesh prevents reading mistakes, that can happen when the hose expands during operation
- Glycerine cushioned pressure gauge absorbs pressure surges which makes pressure reading easier

TECHNICAL DATA

Testing and pressure range:	0 - 40 bar, with 1 bar steps 0 - 570 psi, with 20 psi steps 0 - 0.1 MPa steps
Flow Rate:	max. 6 l / min
Dimensions (L x W x H):	375 x 290 x 300 mm
Connection:	R 1/2"
Mains voltage:	220 - 240 V / 50 HZ and 110 V / 50 - 60 HZ
Performance:	1.3 kW
Container:	ABS-plastic

8



Model	kg	110 V	220 V
Testing pump RP PRO III self-priming with power cable, high-pressure hose and 1/2" connection, filling hose	16.0	V12110016	61185
Filling hose with adaptor	0.5		61001
Testing hose with R 1/2" connection	0.4	V12102000	
Maintenance package RP PRO III in scope of delivery			61186

Testing and leak detection

Testing of water lines and containers



TP 25

Small, robust precision testing pump for pressure testing up to 25 bar

Product profile

APPLICATION AREA

Pressure testing with water or oil of piping in residential and industrial construction as well as for industrial containers up to 25 bar in accordance with international and national standards

KEY FEATURES

- Reliable and precise testing results: the dual-valve system (Twin Valve) enables self-testing of the pump, as well as a precise fine adjustment of the pressure
- Testing hose with steel mesh prevents reading mistakes, that can happen when the hose expands during operation
- Weather and cold-resistant steel container with DURAMANT coating

TECHNICAL DATA

Testing and pressure range:	0 - 25 bar
Hub suction capacity:	approx. 16 ml / stroke
Dimensions (L x W x H):	380 x 215 x 156 mm
Connection:	R 1/2"
Container:	Steel, DURAMANT coated



For the daily work on site



Model	Pressure range	kg		No.
Testing pump TP 25	up to 25 bar	4.6	1	60250
Maintenance package TP 25				60251

RP 30

Simple and light testing pump for compression testing up to 30 bar

Product profile

APPLICATION AREA

Pressure testing with water or oil of piping in residential and industrial construction as well as for industrial containers up to 30 bar in accordance with international and national standards

KEY FEATURES

- Testing hose with steel mesh prevents reading mistakes, that can happen when the hose expands during operation
- Shock and corrosion resistant ABS plastic container with reinforced floor

TECHNICAL DATA

Testing and pressure range:	0 - 30 bar, with 1-bar steps
	0 - 440 psi, with 20 PSI steps
Hub suction capacity:	16 ml / stroke
Dimensions (L x W x H):	440 x 200 x 240 mm
Connection:	R 1/2"
Container:	ABS-plastic



Easy, light and handy: for all common house building applications



Model	Pressure range	kg		No.
Testing pump RP 30	up to 30 bar	4.5	1	61130
High pressure hose with 1/4" connection	0.4			R6112500

¹⁾ Complete terms and conditions at rothenberger.com/roservice
RO SERVICE+ only valid in participating countries

Testing and leak detection

Testing of gas and water lines

ROTEST GW Digital V3

Leakage testing system for gas and water lines with large 4.3" touchscreen display for an easy handling and integrated documentation of all tests up to 20 bar.

Only available in Germany, Austria & Italy



Product profile

KEY FEATURES

- 4.3" Touchscreen or physical buttons for an easy handling
- Pressure and leakage testing for gas pipelines according to TRGI 2018
- Leak rate measurement for gas pipelines according to TRGI 2018 and DVGW 5952
- Pressure and leakage testing for drinking water pipelines according to DIN EN 806-4
- Testing of gas pressure regulators
- Long-term measurement up to 72 hours
- RODATA Software and RODATA App for documentation and data management of all test results

TECHNICAL DATA

Display resolution:	480 x 272
Data transfer:	USB, WiFi
Battery life time:	approx. 8 h testing time, mains operation possible
Pressure range:	
Low pressure sensor:	Pressure range 0 – 1,000 mbar (resolution 0.1 mbar / hPa)
High pressure sensor:	Pressure range 0 - 20 bar / 0 - 2 MPa (resolution 0.01 bar / 0.001 MPa)
Leak rate measurement:	Leak rate 0 – 12 l / h (resolution 0.1 l / h)
Safety class:	IP40
Weight:	5.25 kg

Only available in Germany, Austria and Italy!

WiFi transmitter

Easy data transfer to mobile devices and PCs

4.3" Touchscreen

Easy and clear handling



All-in-One

High- and low-pressure sensor from 1 mbar/hPa up to 20 bar / 2 MPa in one device



No. 1500002677

Pressure and leakage testing for gas pipelines according to TRGI 2018



Testing of gas pressure regulators



Set (No. 1500002677) includes:

GW Digital basic unit incl. power plug, software disk with RODATA V3 software (No. 1500002851), 2x hose 2m low pressure (No. 1500002846), 1x hose 2m high pressure + shut-off valve (No. 1500002845), 2x gas test plug cylindrical size 2 (No. 351272), 2x adaptor 1/2" to NW5 plug (No. 1500002876), adaptor 1/8" to NW5 plug (No. F84215), adaptor nozzle pressure to NW5 plug (No. 61018), air pump (No. 1500002848), double bellow (No. 1500002847), shut-off valve NW5 (No. 61017), supply end cap (No. 61041)

Model _____ No. _____

ROTEST GW Digital V3 – Set gas / water **1500002677**

Only available in Germany, Austria & Italy

Testing and leak detection

Testing of gas and water lines



ROTEST GW Digital V3 - RoData V3 PC-Software

PC software for data management of all tests carried out

Product profile

KEY FEATURES

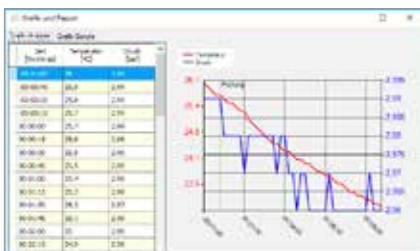
- Creation of a log with graphical representation of the test process
- Management of measurement data – overview of all measurements stored per customer
- Customer administration – import of VCard files (.vcf) possible
- Testing management – clear allocation of one employee per test
- Data transmission via USB cable or WiFi connection possible

TECHNICAL DATA

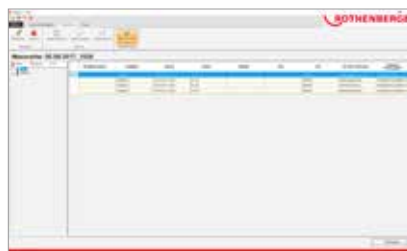
RoData V3 PC-Software:

Compatibility: Windows 2000, XP, 7, 8, 10

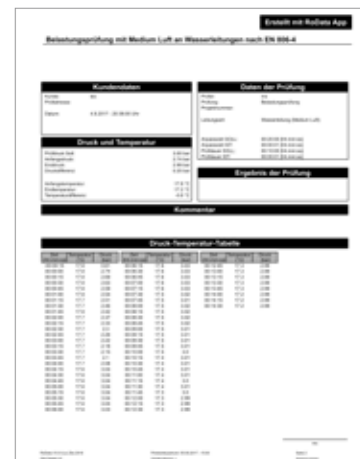
Size: 16.2 MB



Overview of measurement series with graph



Management of measurement series = RoData V3



Sample log according to DIN EN 806-4 with diagram

ROTEST GW Digital V3 - RoData Mobile App

App for the data management of all tests carried out

Product profile

KEY FEATURES

- Simple, quick and professional documentation
- Log ready for immediate use as a PDF
- Suitable for iOS and Android devices
- Measurement data transfer via WiFi
- User-defined company profile set-up in the log
- Ready-made logs for various measurement types (leak testing, usability testing, etc.)

TECHNICAL DATA

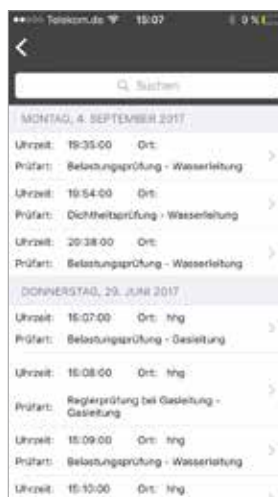
RoData Mobile App:

Compatibility: iOS 8.0 or newer, Android 4.4 or newer

Size: 11 MB



Sample log according to DIN EN 806-4 with measurement value table



Measurement overview
RoData Mobile App



Start screen RoData Mobile App

Testing and leak detection

Testing of gas and water lines

ROTEST GW 150/4

Analogue testing device for gas and water connections using air as the medium



Product profile

APPLICATION AREA

Analogue testing unit for the implementation of the following tests:

Gas: Load and leakage test for newly installed gas lines in accordance with DVGW-TRGI worksheet G 600 (October 2018)

Leakage test from propane liquid gas lines / low-pressure liquid gas lines

Adjustment of the duct pressure on atmospheric burners and forced-air burners

Testing of the appliance connection pressure on gas appliances

Water: Pre-testing and testing of newly installed drinking water lines in accordance with DIN 1988 (TRWI)

KEY FEATURES

- Quick and precise pressure reading over water column without electronic
- Testing time and pressures in accordance with DVGW-TRGI and TRWI clearly arranged on unit cover
- Sturdy unit: High reliability when used on the building site

TECHNICAL DATA

Pressure gauge: 4 bar / 0.4 MPa

Water column: 180 mbar / hPa

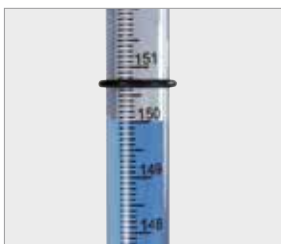
Testing accuracy: Water column 0.1 mbar / hPa (Reading accuracy in accordance with TRGI)
Pressure gauge 0.1 bar / 0.01 MPa (Display range 0 - 4 bar / 0 - 0.4 MPa)

DVGW-TRGI worksheet G 600 (October 2018) conforming!

8



Testing scale up to 150 mbar on transparent extending tube element



Transparent tube element with double o-ring seal



Inspection glass
Water level control



Legible scaling

Continuous scaling up to 150 mbar

Measurement chart in unit

Testing times and testing pressure from lawmakers at a glance

Foam inlay

High transport safety and protection of the components

Compact measuring station

Designed to serve in real-life situations through quick, exact gas pressure measurements

Model in combination with basic unit



No.

with 5 test plugs and supply end cap

7.6

61700

with 5 test plugs without supply end cap


7.3

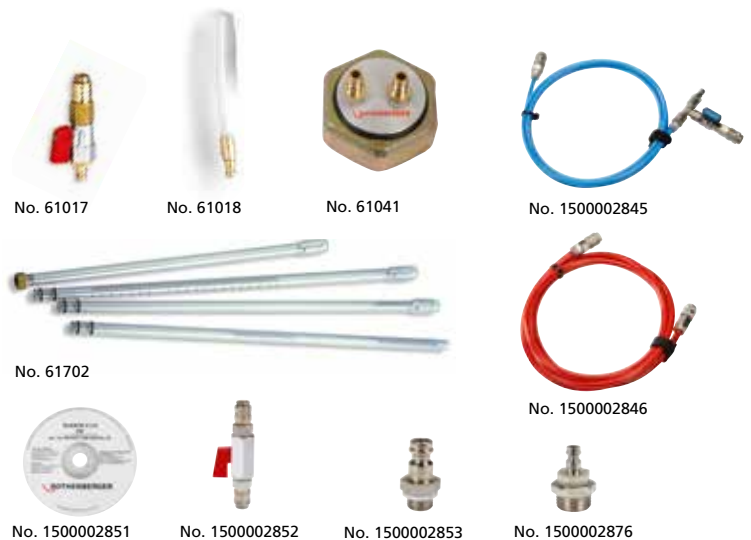
61701

Testing and leak detection

Testing of gas and water lines


Set components


Model		No.
Pressure pump ROTEST GW 150/4	0.30	61011
Bellow f. ROTEST GW 150/4	0.06	61014
Shut-off valve NW5 socket/plug	0.20	61017
Adaptor nozzle pressure to NW5 plug	0.20	61018
O-ring set (6 pcs.) GW 150/4	0.04	61030
Supply End Cap f. ROTEST GW 150/4	0.38	61041
1/8" adaptor to NW5 plug	0.10	F84215
1/2" adaptor to NW5 plug	0.50	150002876
Tube element (4 pcs.) GW 150/4	1.10	61702
Measurement fluid, blue, GW 150/4	0.10	351257
Hose 2 m high pressure + shut-off valve	0.20	1500002845
Hose 2 m low pressure ROTEST GW	0.20	1500002846
Double bellow GW Digital V3	0.10	1500002847
Air pump GW Digital v3	0.14	1500002848
CD RODATA V3 for ROTEST GW Digital V3	0.02	1500002851
Shut-off valve NW5 socket/socket	0.17	1500002852





Gas test plug / adaptor


Suitable for gas lines up to 1.5 bar


Model	Steel exterior pipe Ø inch	Copper exterior pipe Ø mm		No.
Conical shape with pneumatic connection				
Size 0	3/8 - 1/2"	15 - 18	45	351260
Size 1	1/2 - 1"	22 - 28	80	351261
Size 2	3/4 - 1.1/4"	35 - 42	125	351262
Size 3	1.1/4 - 2"	54 - 64	175	351263

Model	Steel exterior pipe Ø inch	Copper exterior pipe Ø mm		No.
Cylindrical shape with pneumatic connection				
Size 1	3/4"	22	60	351271
Size 2	1"	28	75	351272

Model	Steel exterior pipe Ø inch	Copper exterior pipe Ø mm		No.
Conical shape with hose coupling				
Size 0	3/8 - 1/2"	15 - 18	200	351220
Size 1	1/2 - 1"	22 - 28	300	351221
Size 2	3/4 - 1.1/4"	35 - 42	300	351222
Size 3	1.1/4 - 2"	54 - 64	400	351223

Model	Steel exterior pipe Ø inch	Copper exterior pipe Ø mm		No.
Conical shape with 2 ball valves				
Size 1	1/2 - 1"	22 - 28	260	351231
Size 2	3/4 - 1.1/4"	35 - 42	420	351232
Size 3	1.1/4 - 2"	54 - 64	700	351233

Model	Steel exterior Pipe Ø inch	Copper exterior Rohr Ø mm		No.
Conical shape with 1 ball valve				
Size 0	3/8 - 1/2"	15 - 18	200	351225
Size 1	1/2 - 1"	22 - 28	350	351226
Size 2	3/4 - 1.1/4"	35 - 42	390	351227
Size 3	1.1/4 - 2"	54 - 64	600	351228

Model		No.
With double plug valve - with hose snout		
Adaptor/cut-off valve with pn. connection	290	351265



8

Testing and leak detection

Testing of waste water lines

ROLEAK Aqua 3Plus

Easy to use leak detection device with acoustic signal for pipe systems



Product profile

KEY FEATURES

- Leak detection for various pipe materials
- Amplifies flow noise for exact detection of leaks



External groundmicrophone



Acoustic leak detection of heating installations



KEY FEATURES

- Digital wireless connection to headphones
- Possibility to connect an external microphone
- Bluetooth connection for a better and clear noise transmission to headphones. This also allows to control the volume with the handunit

TECHNICAL DATA

3-staged Frequency filter: 1. Stage: 0 - 540 Hz
2. Stage: 540 - 4.000 Hz
3. Stage: 0 - 4.000 Hz

Operating time: ca. 15h Li-Ion Battery

Weight: 250 g (Handheld device)

Level of protection: IP 41

Improved sound compared with previous models!



6-parts Set (No. 1500003533) includes: basic unit, headphones, magnetic adaptor, 2 x extensionstick, tripod-adaptor, ROCASE 4414

Model	kg	No.
ROLEAK Aqua 3Plus	3.1	1500003533
External groundmicrophone	0.5	1500003535

Testing and leak detection

Leak detection on gas lines



ROTEST Electronic 4

Leak detection on gas lines

Product profile

APPLICATION AREA

For the detection of gas in room as well as leaks in pipes. Detects all flammable methane based gases

KEY FEATURES

- Leaks are optically as well as acoustically displayed
- With the help of the 42 cm long, flexible testing head and the integrated lamp, even dark and hard to reach places can be tested
- Quick and precise leak location of even the smallest leak source: The sensitivity of the unit can be adjusted continuously in a range from < 50 ppm - 1 Vol %
- Shock-proof soft case jacket and simple one-handed operation of the unit for use on the building site

TECHNICAL DATA

Detects: Natural gas, propane, butane, methane, acetone, alcohol, ammonia, benzyl, ethylene, gasoline, hydrogen, industrial solvents, jet fuel, paint thinner, naphtha, toluene

Sensitivity: < 50 ppm – 1 Vol % (Methan)



Finds leaks easily



Set (No. 1000003199) includes:
ROTEST Electronic 4, 2x AA battery in ROCASE 4212 (No. 1300003334)

Model	kg	No.
ROTEST Electronic 4	1.25	1000003199

8

ROTEST

Leak detection on gas lines

Product profile

APPLICATION AREA

Ideal for detecting leaks in gas-filled lines, gas cylinders or containers. When a leak is present a blister forms.

KEY FEATURES

- Simple use - always ready to use
- Highly sensitive foaming spray for a quick and reliable locating of leaks

TECHNICAL DATA

Detects gases (for example natural gas, inflammable gas, air)
The leak detection spray is neutral against the most common inflammable gases and refrigerants. The only reaction is the building of foam

Highly sensitive foam spray:
Quick and reliable location of leaks!



DVGW-tested
Reg.-No. NG-5170CL0063



Model	Content	g	kg	No.
ROTEST leak detection spray	400 ml	470	12	65000

¹⁾ Complete terms and conditions at rothenberger.com/roservice
RO SERVICE+ only valid in participating countries








Freezing

System overview	196
Freezing electric	
Pipe freezing systems	196 - 199
Freezing with gas	
Pipe freezing systems	200 - 201

Freezing

System overview

	Freezing electric	Freezing with gas	
	ROFROST Turbo R290 1.1/4" 	ROFROST Turbo R290 2" 	ROFROST CO₂ Set 
Working range Cu:	10 - 42 mm (3/8 - 1.5/8")	10 - 54 mm (3/8 - 2.1/8")	10 - 54 mm (3/8 - 2.1/8")
Working range Fe:	1/8 - 1.1/4"	1/8 - 2"	1/8 - 2"
Reduction inserts:	up to 12 Stk.	up to 15 Stk.	up to 10 Stk.
Freezing hose:	2.5 m	2.5 m	2 m
Refrigerant:	R290	R290	CO ₂ (R 744)
Page	197	198	200

ROFROST Turbo R290 1.1/4" / ROFROST Turbo R290 2"

Pipe freezing system for copper, steel and stainless steel

Flexible refrigerant hoses

Work in confined spaces and store the hoses inside the unit

Simple clamping system

For use even in confined spaces

Compact design

Tough powder coated metal case with soft-grip handle makes the machine highly mobile and ideal for service work

Heat conductive paste

Enables freezing without continuous spraying of the pipe

Wide application area

A range of pipe sizes can be frozen using the supplied pipe inserts



The use of heat conductive paste guarantees optimal freezing



The freezing process starts automatically after installing the freezing clamps



Compact freeze clamp design allows the pipe to be frozen - even close to the wall



ROFROST Turbo R290 1.1/4"

Pipe freezing system for copper, steel and stainless steel



Product profile

APPLICATION AREA

Maintenance, repair and expansion work in sanitary and heating installations

Copper pipes: Ø 10 - 42 mm ROFROST Turbo R290 1.1/4"
 Ø 3/8 - 1.3/8" ROFROST Turbo R290 1.1/4"

Steel pipes: Ø 1/8 - 1.1/4" ROFROST Turbo R290 1.1/4"

KEY FEATURES

- Future-proofed due to the change of the environmentally friendly refrigerant R290
- Compact freezing clamps and shortened thermometer allow working on confined spaces
- The use of heat conductive paste guarantees an optimum icing. It prevents air pockets between the freezing clamps and pipe. The pipe does not need to be sprayed with water
- Reduction inserts in various sizes for all common pipe diameters



9

Model



230 Volt 50 Hz

ROFROST Turbo R290 1.1/4"

with reduction inserts size II, III, V, VII, IX, XII (see ROFROST reduction insert overview) + heat conductive paste

23.5

1500003000

¹⁾ Complete terms and conditions at rothenberger.com/roservice
 RO SERVICE+ only valid in participating countries

Freezing

Freezing electric

ROFROST Turbo R290 2"

Pipe freezing system for copper, steel and stainless steel



Product profile

APPLICATION AREA

Maintenance, repair and expansion work in sanitary and heating installations

Copper pipes: Ø 10 - 54 mm ROFROST Turbo R290 2"
 Ø 3/8 - 2.1/8" ROFROST Turbo R290 2"

Steel pipes: Ø 1/8 - 2" ROFROST Turbo R290 2"

KEY FEATURES

- Future-proofed due to the change of the environmentally friendly refrigerant R290
- Safe freezing: Thermometer on the freezer clamp indicates when the pipe is completely frozen
- The use of heat conductive paste guarantees an optimum icing. It prevents air pockets between the freezing clamps and pipe. The pipe does not need to be sprayed with water
- Reduction inserts in various sizes for all common pipe diameters



9

Model	kg	230 Volt 50 Hz
ROFROST Turbo R290 2" with reduction inserts size II, III, V, VII, IX, D, E, F (see ROFROST reduction insert overview) + heat conductive paste	24.3	1500003001
Expansion set for ROFROST Turbo with reduction inserts size II, III, V, VII		62230
additional sets upon request		

ROFROST App

The ROFROST App supports safe work and the freezing process will be explained step by step.



Application instructions

Application instructions
Check if you have performed the following steps

1. Waterflow interrupted?
2. Select the suitable reduction inserts?
3. Heat conductive paste used?
4. Correct mounted clamp at the pipe?
5. Switched on the ROFROST Turbo R290?

Next step

i Imprint

Checklist for the freezing process

Freezing parameter

Freezing parameter
Select the freezing parameter

ROFROST Turbo R290 1.1/4" recognized
Serial number 3108180080055

Pipe material	Copper (Cu)
Pipe diameter	Ø 22

Recommended minimum freezing time:
14 minutes

Apply freezing parameter

i Imprint

The recommended freeze time is displayed by adjusting the material and diameter

Timer

Timer
Start the freezing process with the following parameters:

ROFROST Turbo R290 1.1/4"
Pipe material Copper (Cu)
Pipe diameter Ø 22

Recommended minimum freezing time:
14 minutes

14:00

Start timer

i Imprint

The integrated timer will respond after the freezing time has elapsed

ROFROST Turbo reduction inserts



ROFROST Turbo 1.1/4" reduction inserts

Size	Nominal size Cu	Nominal size Cu	Nominal size Fe	g	No.
Size I	10 mm	3/8"	1/8"	190	62217
Size II	12 mm	1/2"	-	180	62211
Size III	14/15 mm	-	1/4"	170	62212
Size IV	16 mm	5/8"	-	170	62219
Size V	18 mm	-	3/8"	165	62213
Size VI	20 mm	3/4"	-	155	62224
Size VII	22 mm	7/8"	1/2"	145	62214
Size VIII	-	1"	-	125	62226
Size IX	28 mm	-	3/4"	110	62215
Size X	-	1.1/8"	-	90	62227
Size XI	32 mm	1.1/4"	-	80	62221
Size XII	35 mm	1.3/8"	1"	65	62216



ROFROST Turbo 2" reduction inserts

Size	Nominal size Cu	Nominal size Cu	Nominal size Fe	g	No.
Size A	28 mm	-	3/4"	190	62231
Size B	-	1.1/8"	-	180	62232
Size C	32 mm	1.1/4"	-	170	62233
Size D	35 mm	1.3/8"	1"	170	62234
Size E	42 mm	-	1.1/4"	165	62235
Size F	-	-	1.1/2"	155	62236
Size G	54 mm	2.1/8"	-	145	62237

The reduction insert size E, 42 mm serves as an adaptor piece for fitting ROFROST Turbo 1.1/4" reduction inserts size I – size XII

ROFROST heat conductive paste



No. 62291

For a perfect freezing result



Heat conductive paste enables fully automatic freezing without spraying!

Description	Contents	g		No.
ROFROST heat conductive paste	150 ml	130	1	62291

Freezing

Freezing with gas

ROFROST CO₂ Set

Freezing unit for the freezing of pipes up to 2" without electricity



Product profile

APPLICATION AREA

Maintenance, repair and expansion work in sanitary and heating installation. No electrical connection required!

TECHNICAL DATA

Copper pipes: Ø 10 mm - 54 mm
 Ø 3/8 - 2.1/8"

Steel pipes: Ø 1/8 - 2"

KEY FEATURES

- Flexible use, freezing possible without electricity!
- Because of the low temperature (up to -79° C) the dry ice enables a faster freezing as every other electrical freezing unit that uses refrigerant
- Piping up to 2" can be frozen with just one unit
- Freezer heads made out of extremely cold-resistant special plastic



Set without carbon dioxide bottles!

Use carbon dioxide bottles only with stand pipes

9


19-part set (No. 65030) includes: 2 handles with feed valves (No. 65032), 2 high pressure hoses (No. 65033), 10 pairs of freezer heads (2 for each pipe dimension), stopper for one-sided freezing (No. 65049), wrench (No. 65045), internal hexagonal screwdriver (No. 65046), T-piece (65034), plastic carrying case (65031)


for copper pipes Ø mm	for copper pipes Ø inch	for steel pipes Ø inch	kg	No.
10 - 54	1/2 - 2.1/8"	1/8 - 2"	4.9	65030

Freezer Heads



ROFROST Freezer Heads

Size	for copper pipes Ø mm	for copper pipes Ø inch	for steel pipes Ø inch	 g	No.
1	10 - 12	1/2"	1/8"	60	65035
2	14 - 15	-	1/4"	60	65036
3	16 - 18	5/8"	3/8"	70	65037
4	22	3/4 - 7/8"	1/2"	70	65038
5	28	1.1/8"	3/4"	110	65039

Size	for copper pipes Ø mm	for copper pipes Ø inch	for steel pipes Ø inch	 g	No.
6	35	1.3/8"	1"	110	65040
7	42	1.5/8"	1.1/4"	210	65041
8	-	-	1.1/2"	210	65042
10	-	-	2"	250	65044



Inspection and locating

System overview	204 - 205
Video inspection	
ROSCOPE mini	206
ROSCOPE i2000	207
Inspection modules for ROSCOPE i2000	208 - 209
Locating module ROLOC Plus	210
ROSCOPE i2000 and ROCAM 4 Plus app	211
ROCAM 4 Plus	212 - 213
ROCAM 4 Plus accessories	213 - 215



Inspection and locating

System overview

ROSCOPE family



ROSCOPE mini

ROSCOPE i2000 modules

ROSCOPE mini

Module TEC

Module 25/16

Module 25/22

Module
ROLOC PLUS



Application:	Hollow spaces	Hollow spaces	Ø 50-100 mm	Ø 40-100 mm	Locating of sondes
Display size:	2.5"	3.5"	3.5"	3.5"	3.5"
Touchscreen:	–	✓	✓	✓	–
Cable length:	1.2 m	1 m	16 m	22 m	–
Cable-Ø:	5.5 mm	9 mm	8.5 mm	5.5 mm	–
Camera head-Ø:	8.5 mm	17 mm	25 mm	25 mm	–
Self levelling:	180°	✓	✓	–	–
Transmitter:	–	–	✓	–	–
Frequency:	–	–	512 Hz	–	512 Hz, 640 Hz, 33 kHz
Picture format:	JPG	JPG	JPG	JPG	–
Picture resolution:	320 x 240 pixel	320 x 240 pixel	640 x 480 pixel	320 x 240 pixel	–
Video format:	–	AVI	AVI	AVI	–
Video resolution:	–	320 x 240 pixel	320 x 240 pixel	320 x 240 pixel	–
Storage:	On-board	SD-card	SD-card	SD-card	–
WiFi:	–	✓	✓	✓	–
Protocol feature:	–	–	–	–	–
Audio-recording:	–	✓	✓	✓	–
Data handling:	–	via app	via app	via app	–

Page

206

208

209

208

210

10

ROCAM 4 Plus



APP FOR SMARTPHONE AND TABLET
EDITING AND TRANSFERING
OF IMAGES AND VIDEOS.
AVAILABLE FOR iOS AND ANDROID!



ROCAM 4 Plus



**ROCAM 4 Plus
30 m**



**ROCAM 4 Plus
65 m**



**ROCAM 4 Plus
mini module**



25 mm camera head:	–	–	40-100 mm
30 mm camera head:	Ø 70-150 mm	Ø 70-150 mm	–
40 mm camera head:	Ø 100-300 mm	Ø 100-300 mm	–
Display size:	10.4"	10.4"	10.4"
Touchscreen:	✓	✓	✓
Cable length:	30 m	65 m	8 m / 16 m
Metre counter:	✓	✓	✓
Cable-Ø:	7 mm	7 mm	5.5 mm
Self levelling:	✓	✓	–
Transmitter:	✓	✓	–
Frequency:	33 kHz	33 kHz	–
Picture format:	JPG	JPG	JPG
Picture resolution:	720 x 600 pixel	720 x 600 pixel	648 x 488 pixel
Video format:	AVI	AVI	AVI
Video resolution:	720 x 600 pixel	720 x 600 pixel	648 x 488 pixel
Storage:	SD-card	SD-card	SD-card
WiFi:	✓	✓	✓
Protocol feature:	✓	✓	✓
Audio-recording:	✓	✓	✓
Data handling:	✓	✓	✓

Page

212

213

213

Inspection and locating

Video inspection

ROSCOPE mini



A constant companion – by having an extremely compact design, it can be stowed tidily into every tool case. Minor works, like the inspection of hollow spaces are not a challenge anymore. The combination of its robust construction with modern technology makes it a tool for every toolbox.

Product profile

APPLICATION AREA

The ROSCOPE mini is perfect for an easy and quick inspection of minor works. Blockages in drainages, pipelines, shower and bath connections, gutters and hollow spaces can be easily inspected.

KEY FEATURES

- Intuitive handling with the first touch
- The Ø 8.5mm camera head and the 120 cm camera cable are perfect for minor works and are maximizing the pace of work
- Electronical 180° rotation for the perfect perspective in every situation
- Waterproofed camera head
- Tool less mounting of accessories like the magnet or 90° mirror

TECHNICAL DATA

Dimensions:	152 x 90 x 40 mm
Display size:	2.5"
Cable length:	1.2 m
Cable-Ø:	5.5 mm
Cable head-Ø:	8.5 mm
Leveling:	180°
Storage:	30 pictures

Adjustable illumination
7 light levels for best lighting conditions

180° rotatable picture
Fast and precise analysis on a 2.5" display with triple zoom

Intuitive handling
Self-explanatory service in live and review mode

Quick inspection of hollow spaces before and after installations

Always ready to hand, due to handy belt clip

Ø 8.5 mm waterproof camera head
Perfect working conditions in small diameters

1.2 m camera cable
For quick and easy inspection

Included belt clip
Comfortable wear

Space-saving storage
Camera cable can be easily wound up around the housing

Accessories included
Integrated magnet for catching metal pieces and mirror for the perfect view in a 90° bow

Magnet-accessory

Mirror-accessory



10

Set (No. 100002268) includes: ROSCOPE mini basic unit, mirror and magnet accessories, 4x AA batteries, ROBOX B2350 (No. 150002641)

Model	No.
ROSCOPE mini set	100002268

ROSCOPE i2000

Inspection and locating technology combined in one unit with multiple functions. Modular system allows for various applications.



Product profile

APPLICATION AREA

The ROSCOPE i2000 covers almost all inspection techniques within living and working spaces. Camera and locating modules allow a multifunctional use. WiFi technology enables a quick and easy data transfer.

KEY FEATURES

- User-friendly touchscreen monitor and simple menu guidance
- Easy data transfer for subsequent processing
- Audio recording and playback possible without further equipment
- USB charging function

TECHNICAL DATA

Display: 3.5" touchscreen (color)
Video format: AVI
Picture format: JPEG, 320 x 240 pixels
Connection: Mini-USB, AV-Out, SD-card slot
Power supply: Li-Ion battery 3.7 V / 5.2 Ah

Versatile and user-friendly!

3.5" touchscreen

320 x 240 pixel resolution (JPEG)

Ergonomic handling

Function keys arranged closely together

Slip-free handle

For comfortable and effort saving operation - even over long periods of time

Compatible connection

Previous ROTHENBERGER modules can be used

WiFi

Easy data transfer to mobile devices

SD-card slot

Memory space for audio, video and image data

Integrated microphone

Integrated speaker

For audio playback



Powerful Li-Ion battery

For an extra long battery life and short charging times

10

Modular concept:

4 different modules for the ROSCOPE i2000 basic unit, for visual inspection of pipes and hollow spaces as well as locating of pipes and sondes.

Module TEC

Self-leveling camera for the inspection of hollow spaces and hard to reach areas



Module 25/16 and 25/22

Waterproof pipe module for pipe inspection in 90° bends from Ø 40 mm to 100 mm



Module ROLOC PLUS

Easy to use pipe and sonde locating device incl. precise depth measurement



¹⁾ Complete terms and conditions at rothenberger.com/roservice. RO SERVICE+ only valid in participating countries.

Inspection and locating

Video inspection

ROSCOPE i2000 module TEC

High-performance camera for the inspection of hollow spaces and hard to reach areas

Product profile

KEY FEATURES

- User-friendly touchscreen monitor and simple menu guidance
- Self-leveling camera head
- Recording and playback of the inspection on video (AVI) or photo (JPEG)
- Waterproof camera head as per IP 68

TECHNICAL DATA

Display:	3.5" touchscreen (color) (technical data about basic unit available on page 208)
Camera head:	Ø 17 mm, self-leveling and waterproof, with 4 LED lights
Brightness:	100 LUX (0.5 m)
Cable length:	1 m
Power supply:	Li-Ion battery 3.7 V / 5.2 Ah
Weight:	0.9 kg

Set ROSCOPE i2000 module TEC (No. 150000696) includes: ROSCOPE i2000 basic unit, module TEC, charger, ROCASE 4212, foam inlay

Model	No.
ROSCOPE i2000 module TEC	150000696
Module TEC (without basic unit)	69601

Self-leveling camera head



Inspection of hollow spaces



Camera head with high-performance LEDs



ROSCOPE i2000 module 25/22

High-performance camera for the inspection of pipes from Ø 40 up to 100 mm

Product profile

KEY FEATURES

- Recording and playback of the inspection on video (AVI) or photo (JPEG)
- Extremely flexible camera head for 90° bends starting from Ø 40 mm

TECHNICAL DATA

Display:	3.5" touchscreen (color) (technical data about basic unit available on page 192)
Camera head:	Ø 25 mm, waterproof, with 8 LED lights
Brightness:	100 LUX (0.5 m)
Cable length:	22 m
Cable diameter:	5.5 mm
Power supply:	Li-Ion battery 3.7 V / 5.2 Ah
Weight:	3.1 kg

Set ROSCOPE i2000 module 25/22 (No. 100000860) includes: ROSCOPE i2000 basic unit, module 25/22, module TEC, charger, plastic carrying case

Model	No.
ROSCOPE i2000 module 25/22 + module TEC	100000860
Module 25/22 (without basic unit)	69603
Guidance ball for module 25/16 and 25/22	74629

**Cable length:
22 m!**



Inspection of rain downpipes



Inspection of floor drains



ROSCOPE i2000 module 25/16

High-performance camera for the inspection of pipes from Ø 50 up to 100 mm. With an integrated transmitter for the precise locating of the camera head.



Product profile

KEY FEATURES

- Recording and playback of the inspection on video (AVI) or photo (JPEG)
- Extremely flexible camera head for 90° bends starting from Ø 50 mm
- Can be used with guidance ball up to Ø 100 mm
- Self-leveling picture
- Integrated transmitter for the precise locating of the camera head
- ROSCOPE i2000 basic unit can also be used as control unit for the ROLOC PLUS locating module

TECHNICAL DATA

Display:	3.5" touchscreen (color) (technical data about basic unit available on page 208)
Camera head:	Ø 25 mm, self-leveling and waterproof, with 4 extra bright LED lights
Brightness:	125 LUX (0.5 m)
Cable length:	16 m
Cable diameter:	8.5 mm
Frequency:	512 Hz
Power supply:	Li-Ion battery 3.7 V / 5.2 Ah, 2 AA batteries (transmitter)
Weight:	3.9 kg

Simple locating of the camera head with the integrated transmitter!

3.5" touchscreen

320 x 240 Pixel resolution

Battery compartment

For the power supply of the integrated transmitter (2 AA batteries included in delivery)

Rubberized base

Stable stand without slipping and damaging the surface

Inspection of access line



Inspection of rain drainpipes



WiFi

Easy data transfer to mobile devices

Integrated transmitter

For the precise locating of the camera head

Self-leveling camera head

Picture is always upright, no loss of orientation



Guidance ball for module 25/16 and 25/22

For centring of the camera head, better illumination of the pipe



No. 74629

Set ROSCOPE i2000 module 25/16 (No. 100000842) includes: ROSCOPE i2000 basic unit, module 25/16, module TEC, charger, plastic carrying case

Model	No.
ROSCOPE i2000 module 25/16 + module TEC	100000842
Module 25/16 (without basic unit)	150000052
Guidance ball for module 25/16 and 25/22	74629

¹⁾ Complete terms and conditions at rothenberger.com/roservice. RO SERVICE+ only valid in participating countries.

Inspection and locating

Video inspection

ROSCOPE i2000 module ROLOC PLUS

Easy to use pipe and sonde locating device. Available as a complete unit as well as locating module for the ROSCOPE i2000 basic unit



Product profile

KEY FEATURES

- Pin-point location of the sonde
- Precise depth measurement
- Different frequencies can be chosen
- Simple and clear menu design guides step-by-step through the locating process
- Telescopic function makes transporting in case easier

TECHNICAL DATA

Display:	3.5" touchscreen (color) (technical data about basic unit available on page 208)
Frequencies:	512 and 650 Hz, 33 kHz active/passive, 50/60 Hz passive
Power supply:	Li-Ion battery 3.7 V / 5.2 Ah
Dimensions:	95 x 32 x 30 cm (operating mode) 67 x 32 x 9 (transportation mode)
Weight:	1.4 kg

Also for use with ROCAM 4 Plus



Simple menu guidance
Guides step-by-step to targeted position

Multi-frequencies
Locating of the most common camera heads

Telescopic function
For easier transport in case

Depth measurement
Pin-point location of the transmitter position

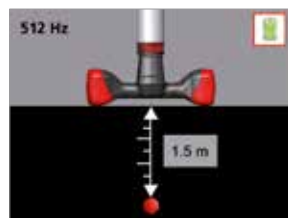
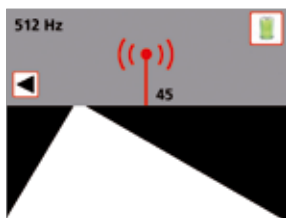


Easy to use pipe and sonde locating device incl. precise depth measurement

10

Target is left of the running direction. Correction of your direction to the left is necessary.

Depth measurement with a push of the button



Set ROSCOPE i2000 module ROLOC PLUS (No. 100000065) includes: ROSCOPE i2000 basic unit, module ROLOC PLUS; module TEC, charger, plastic carrying case

Model	No.
ROSCOPE i2000 module ROLOC PLUS + module TEC	100000861
Module ROLOC PLUS (without basic unit i2000)	150000057

¹⁾ Complete terms and conditions at rothenberger.com/roservice. RO SERVICE+ only valid in participating countries.

ROSCOPE i2000 and ROCAM 4 Plus app

App for smartphone and tablet to edit and send recorded image data



Product profile

KEY FEATURES

- WiFi-transmitter allows a image transfer live from the camera to mobile devices
- Integrated editing function to mark and name specific pipeline damages
- Synchronizing of stored images of the camera to allow further processing
- Sending of edited pictures directly from the place of action

TECHNICAL DATA

ROSCOPE i2000:

Compatibility: iOS 5.1 – iOS 13.0, Android 4.0 or newer
Size: 4.1 MB

ROCAM 4:

Compatibility: iOS 8.1 or newer, Android 4.0 or newer
Size: 12 MB

Live Image



Editing Display



Album



Album

Picture and video recording

Settings / notes

Editing

Change to edit settings

- Color palette
- Pen and rubber
- Text
- Rectangle, circle, arrow



Available for iOS (until version 13.0) and Android!

10



Inspection of basin drains



Sending of edited pictures directly from the place of action

Inspection and locating

Video inspection

ROCAM 4 Plus - 30 m

Inspection camera for pipes from Ø 40 – 300 mm with 30 or 65 m cable length, with integrated software for documentation and large removable 10.4" touchscreen.



Product profile

KEY FEATURES

- Picture editing, change of camera settings and menu guidance via the 10.4" color-touchscreen
- Direct recording of pictures (JPG) or video (AVI, resolution 720 x 600) as well as editing options (e.g. documentation of damage)
- Fast data recording with integrated keyboard to mark, highlight and name damages
- Picture and video transmission via WiFi, Micro-HDMI, Mini-USB, SD-Card
- Livestream of picture and data via WiFi to the ROCAM 4 app
- Self-levelling and exchangeable camera heads
- Exchangeable reels for various working ranges
- New platform based battery technology

TECHNICAL DATA

Picture and video format: JPG / AVI (resolution 720 x 600)
Camera head: Ø 25 mm, waterproof with 8 LEDs
 Ø 30 mm, self-levelling and waterproof with 10 LEDs
 Ø 40 mm, self-levelling and waterproof with 36 LEDs
Working range: Ø 40 - 100 mm (mini-module)
 Ø 70 - 150 mm (30 mm camera head)
 Ø 100 - 300 mm (40 mm camera head)
Cable length: 30 m version
 65 m version
 8 m mini-module (optional)
Cable diameter: 7 mm (30 m und 65 m reel)
 5.5 mm (mini-module)
Transmitter frequency: 33 kHz
Power supply: Li-Ion battery 18 V/4 Ah
 Main adaptor 110 - 230 V, 50 - 60 Hz (optional)

WiFi transmitter

Simple data transmission to mobile devices

Removable display unit with 10.4" color-touchscreen

Full functionality, even in confined spaces

Integrated speakers

Direct audio replay

Cover protected connections for SD-Card, Micro-Hdmi, Mini-USB

Locating with ROSCOPE module ROLOC PLUS



Li-Ion battery 18V/4.0 Ah (same as ROMAX 4000)

Long battery operation time (up to 6 hours)

Digital metre count

Precise determination of distance to camera head

Exchangeable reel system 30 m / 8 m

Large operating range from Ø 40 mm pipe diameter

Integrated microphone

Voice recording for documentation possible

Please note: This machine cannot be upgraded to a 65m cable.

Set (No. 1500002613) includes: ROCAM 4 Plus - 30 m cable, Ø 30 mm camera head, guidance ball, accessory bag including location transmitter, USB-cable, pencil, RO BC14/36 battery charger, RO BP18/4, 4.0 Ah 18V Li-Power battery

Model	No.
ROCAM 4 Plus - 30 m cable, 30 mm head, EU	1500002613
ROCAM 4 Plus - 30 m cable, 40 mm head, EU	1500002614

²⁾ More information at cordless-alliance-system.com

¹⁾ Complete terms and conditions at rothenberger.com/roservice. RO SERVICE+ only valid in participating countries.

ROCAM 4 Plus - 65 m

Inspection camera for pipes from Ø 40 – 300 mm with 65 m cable length, with integrated software for documentation and large removable 10.4" touchscreen.



Exchangeable reel system
65 m / 30 m / 8 m

Large operating range from
Ø 40 mm pipe diameter

Transport trolley with extendible handle

Comfortable transport over long distances

New platform based battery technology



Transport trolley with extendible handle



Set (No. 1500002615) includes: ROCAM 4 Plus - 65 m cable w/ transport trolley, Ø 30 mm camera head, guidance ball, accessory bag including: location transmitter, USB-cable, pencil, RO BC14/36 battery charger, RO BP18/4, 4.0 Ah 18V Li-Power battery

Model	No.
ROCAM 4 Plus - 65 m cable, 30 mm head, EU	1500002615
ROCAM 4 Plus - 65 m cable, 40 mm head, EU	1500002616

10

ROCAM 4 Plus mini module

Easy extension of the working range of the ROCAM 4 for pipes Ø 40 – 100 mm



Product profile

KEY FEATURES

- Professional inspection of small pipe diameters
- Easy handling due to Exchange reel system

TECHNISCHE DATEN

Camera head:	Ø 25 mm, waterproof with 8 LED lights
Working range:	Ø 40 - 100 mm
Cable length:	8 m / 16 m
Cable diameter:	5.5 mm



Model	No.
ROCAM 4 Plus mini module, 16 m cable	1500003296

²⁾ More information at cordless-alliance-system.com

¹⁾ Complete terms and conditions at rothenberger.com/roservice. RO SERVICE+ only valid in participating countries.

Inspection and locating

Video inspection

ROCAM camera heads

Camera heads made of high-quality materials for professional inspection of pipes from Ø 70 up to 300 mm



Product-profile

KEY FEATURES

Excellent brightness:

- The ROCAM camera head Ø 30 mm has over 10 ultra bright LED lights, that effortlessly illuminate pipes up to Ø 150
- The camera head can be mounted with a Ø 40 mm camera head for larger pipe diameters

Pressure tight screw slip-ring connection:

- Pressure tight connection (3 bar) between camera head and push cable
- High resistance to shock and impact
- Quick and toolless exchange of the camera heads
- No burden from electrical connections

High flexibility and resistant:

- Flexible spring provides 90° curveability in pipes up to Ø 70 mm when enough stability is provided
- Pressure tight up to 3 bar with the stainless steel casing
- Scratch and impact resistant with the sapphire glass objective

KEY FEATURES

Mountable transmitter:

- Optional 33 kHz transmitter can be used to determine the length of the camera head (90° from Ø 70)
- In small pipe diameters the transmitter can also be used without the camera head to determine the course of the pipe without a visual inspection

TECHNICAL DATA

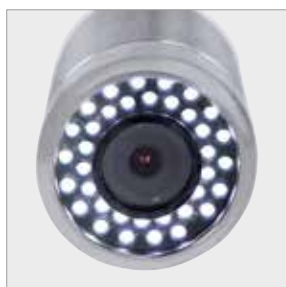
Camera head:	Ø 30 mm with 10 LED lights Ø 40 mm with 36 LED lights self-leveling and waterproof
Brightness:	175 LUX (0.5 m), camera head Ø 30 mm 666 LUX (0.5 m), camera head Ø 40 mm

Always an upright picture!

10



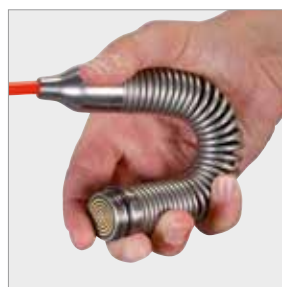
Excellent illumination



Pressure tight screw slip-ring connection



High flexibility and durability



Mountable transmitter



Model

No.

Camera head Ø 30 mm

1500000123

Model

No.

Camera head Ø 40 mm

1500000122

Rolling skids

Recommended for distances from 10 m

APPLICATION AREA

Rolling skids RS40/150 for pipe diameters Ø 150 - 200 mm
Rolling skids RS40/200 for pipe diameters Ø 200 - 300 mm

KEY FEATURES

- Optimized view of the pipe section
- Less pushing resistance with the fully rubberized wheels



Model	g	No.
For camera heads Ø 40 mm:		
Rolling skids Ø 150 mm	700	69118
Rolling skids Ø 200 mm	700	69119
For camera head Ø 30 mm::		
Adapter Ø 30 to Ø 40mm	45	1000001836

Brush attachments

To improve the overview in pipes from Ø 100 – 200 mm

APPLICATION AREA

Brush attachment Ø 100 for use in pipe Ø 100 - 150 mm
Brush attachment Ø 150 for use in pipe Ø 150 - 200 mm

KEY FEATURES

- Optimized view of the pipe section through centring in the pipe
- Dirt will not accumulate in front of the lens
- Good curveability with the brush flexibility



Brush attachment spiral feather (rear) Brush attachment camera head (front)

*Use with guidance ball No. 69112 / 1500000817

Model	g	No.
Brush attachment Ø 100*	200	69113
Brush attachment Ø 150*	300	69117

Guidance ball ROCAM 4 Plus

For centring of the camera head in pipes for a better overview and illumination

APPLICATION AREA

Guidance ball for pipe diameters Ø 70 - 150 mm
Guidance ball with brush attachment for pipe diameters Ø 70 - 200 mm

KEY FEATURES

- Optimized view of the pipe section through centring in the pipe
- Dirt will not accumulate in front of the lens



No. 69112 / 1500000817

No. 69111 / 1500000120

Model	g	No.
For camera heads Ø 30 mm:		
Guidance ball for Ø 150 mm	200	1500000120
Guidance ball for brush attachments	200	1500000817
For camera heads ø 40 mm:		
Guidance ball for ø 200 mm	200	69111
Guidance ball for brush attachments	200	69112

Battery pack system CAS, mains adaptor and charger

KEY FEATURES

- Extend the mobile operation spare battery
- No unintentional release of the battery, battery lock with click mechanism
- External battery charger, independent charging of the battery, higher mobility

TECHNICAL DATA

Battery: 18 V / 4.0 Ah, Li-Ionen



Model	No.
RO BP18/4, 4.0 Ah 18V Li-Power battery	1000001653
RO BC 14/36, battery charger, 230 V, EU	1000001654
ROCAM 4 Plus adaptor, 230 V, EU	1000002085

²⁾ More information at cordless-alliance-system.com



11



Flushing and pipe cleaning

System overview	218 - 219
Flushing	
Flushing compressors	220 - 222
Cleaning chemicals	222
Decalcifying	
Decalcifying pumps	223
Decalcifying chemicals	224
Filling	
Solar filling pump	225
Pipe cleaning manual	
Manual pipe and drain cleaning devices	226 - 228
Pipe cleaning electric	
Manual pipe and drain cleaning machines	229
Sectional drain cleaning machines	230 - 232
Drum drain cleaning machines	233 - 236
Accessories pipe cleaning electric	237 - 239
Drain cleaning spirals	
Spirals	240 - 241
Drain cleaning tools	
Heads and augers	242 - 246
Tool and spiral sets	247 - 248
Accessories drain cleaning spirals	249
System overview high pressure drain cleaners	250
High pressure drain cleaning	
High pressure drain cleaners	250

Flushing and pipe cleaning

System overview

Flushing



	ROPULS	ROPULS eDM
Connection:	1"	1"
Max. pipe diameter:	Ø 50 mm	Ø 50 mm
Max. water pressure:	7 bar	7 bar
Documentation:	-	✓
Page:	221	220

Pipe cleaning



	WC-Blitz	ROPOWER HANDY	ROSPIMATIC CL	ROSPI 6 H+E Plus	ROSPI 8 H+E Plus
Operation mode:	Manual	Manual	Electric	Manual / electric	Manual / electric
Working range:	Ø 50 - 100 mm	Ø 50 - 100 mm	Ø 20 - 50 mm	Ø 20 - 50 mm	Ø 20 - 50 mm
Max. spiral length:	1 m	2.3 m	7.5 m	4,5 m	7.5 m
Spiral diameter:	13 mm	16 mm	8 mm	6 mm	8 mm
Power:	-	-	-	-	-
Page:	228	228	229	227	227



	RODRUM M 13	RODRUM M 16	RODRUM L 16	R 550	R 600
Operation mode:	Electric	Electric	Electric	Electric	Electric
Working range:	Ø 70 - 100 mm	Ø 70 - 125 mm	Ø 70 - 125 mm	Ø 20 - 100 mm	Ø 20 - 150 mm
Max. spiral length:	30 m	45 m	45 m	40 m	60 m
Spiral diameter:	13 mm	16 mm	16 mm	16 mm	8*/10*/16/22 mm
Power:	620 W	620 W	620 W	440 W	690 W
Page:	236	236	236	230	230

Decalcifying

ROCAL 20



ROMATIC 20



Tank volume:	15 l	15 l
Volume flow:	40 l/min	40 l/min
Delivery height:	10 m	10 m
Motor rating:	150 W	150 W
Max. temperature:	50 °C	50 °C
Flow reversal:	Manual	Automatic

Page:

223

223

Pipe cleaning

**ROSPI 10
H+E Plus**



**Manual drain
cleaner 3 S**



RODRUM S 10



RODRUM S 13



**RODRUM
VarioClean**



Manual / electric	Manual	Electric	Electric	Electric
Ø 20 - 70 mm	Ø 50 - 100 mm	Ø 40 - 70 mm	Ø 50 - 100 mm	Ø 40 - 100 mm
10 m	15 m	10 m	15 m	10 m** 15 m
10 mm	13 mm	10 mm	13 mm	10 mm** 13 mm
–	–	440 W	440 W	–

227

228

233 - 234

233 - 234

235

**R 600
VarioClean**



R 650



R 750



RODRUM L 20



Electric	Electric	Electric	Electric
Ø 20 - 150 mm	Ø 20 - 150 mm	Ø 50 - 200 mm	Ø 70 - 250 mm
60 m	65 m	80 m	60 m
8*/ 10*/ 16/ 22 mm	8*/ 10*/ 16/ 22 mm	16*/ 22 mm / 32 mm	20 mm
–	1,350 W	1,400 W	620 W

231

232

232

236

* only usable with collet, clamping jaws or adaptor magazine (see page 238)

** With additionally available accessories

¹⁾ More information at cordless-alliance-system.com

Flushing and pipe cleaning

Flushing

ROPULS eDM flushing compressor

For scouring and cleaning of heating systems and flushing of drinking water pipes according to DIN 1988-2 / EN 806 with protocol function



Product profile

KEY FEATURES

- **One unit – three uses** for safety and energy efficiency:
 - Flushing of floor heating systems / heating circuits
 - Flushing of drinking water pipes as per DIN 1988-2/EN 806
 - Sanitizing of drinking water pipes
- Compact dimensions and practical carriage for simple handling during transport and at the building site
- Two flushing speeds (impulse and permanent air flushing) for good cleaning results
- Easy to use with the clearly arranged control panel
- Chemical cleaning with ROCLEAN accessories possible
- Free app for easy, professional creation of flushing-protocols as PDF files

TECHNICAL DATA

Pipe connection:	R 1" GK-Coupling
Max. pipe diameter:	DN 50/2"
Max. flow rate:	5 m ³ /h
Max. water pressure:	7 bar
Max. water temperature:	30 °C
Protection class:	IP 20
Oil deposition rate:	99.9%
Particle retention rate:	0.3 µm compressor
Max. operating pressure:	8 bar
Engine power:	1.5 kW
Mains connection:	230 V - 50 Hz
Dimensions (H x W x D):	630 x 380 x 340 mm

Large LED display for flow rate amounts and metering impulse, membrane keyboard with program selection keys

Clearly arranged control panel

Quick connect NW 7.2

For connecting pneumatic tools

Function switch

Enables you to change to **ROCLEAN** function

ROPULS eDM App with documentation feature



ROPULS eDM with ROCLEAN function for cleaning and conservation



For removing deposits in floor heating and radiators

Clean heating systems save energy

Pre-commission cleaning of construction material and residues

Clean, proper hygienic pipe systems

Flushing of drinking water pipes with pulsing compressed air water mix as per DIN 1988-2/EN 806

Safety for plumbers and plant operators

ROPULS eDM – Documentation

- ✓ Easy
- ✓ Fast
- ✓ Professional

ROCLEAN function, optional available for ROPULS eDM and ROPULS Flushing compressor!

Scope of delivery (No. 1000001134): ROPULS eDM flushing compressor, 2 x 1 m fabric hose 1" with GK coupling

Model	kg	No.
ROPULS eDM flushing compressor with hoses	28	1000001134

ROPULS eDM App

Professional working and documentation due to eDM (electronic Data Management)



KEY FEATURES

- Report can be e-mailed immediately as a PDF
- Transfer of flushing data via Bluetooth
- Applicable for Android and Windows devices
- Easy, fast, professional documentation
- Company profiles and protocols individually customizable
- Live data transfer to handheld unit
- Templates for various flushings-protocols available



ROPULS flushing compressor

With the same range of functionality as ROPULS eDM, but without eDM (electronic Data Management)



For removing deposits in floor heating and radiators

Clean heating systems save energy

Pre-commission cleaning of construction material and residues

Clean, proper hygienic pipe systems

Flushing of drinking water pipes with pulsing compressed air water mix as per DIN 1988-2 / EN 806

Safety for plumbers and plant operators

Function switch

Enables you to change to **ROCLEAN** function

ROCLEAN function, optional available for ROPULS eDM and ROPULS Flushing compressor!

Scope of delivery (No. 1000000145): ROPULS flushing compressor, 2 x 1 m fabric hose 1" with GK coupling

Model	kg	No.
ROPULS flushing compressor with hoses	28	1000000145

ROPULS with ROCLEAN function:
Flushing of drinking water pipes



ROPULS flushing compressor with ROCLEAN function



ACCESSORIES

Model	No.
ROCLEAN Injector	1000000190
Pressure regulator 2 bar	1500000203
ROPULS extension handle	15000003517

ROCLEAN cleaning and conservation on page 222



¹⁾ Complete terms and conditions at rothenberger.com/roservice
RO SERVICE+ only valid in participating countries

²⁾ Only for Android devices

Flushing and pipe cleaning

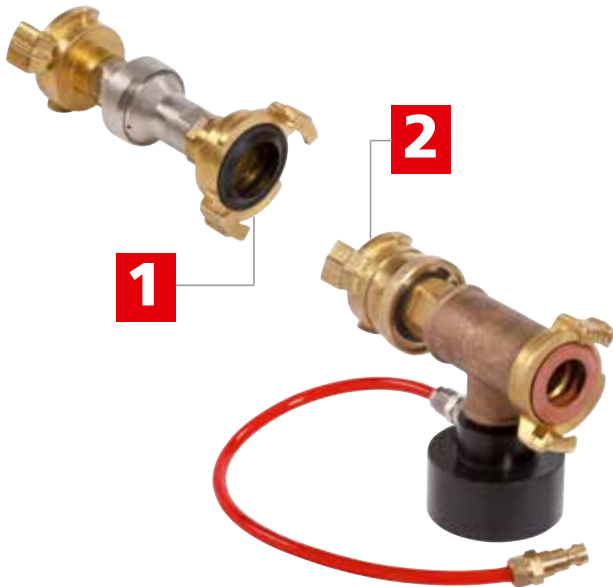
Flushing

ROCLEAN function

For cleaning and conserving radiator heating systems, surface heating systems as well as for disinfection of drinking water lines

1 The pressure reducer has to be installed on the water input side of the ROPULS flushing compressor. This maintains the incoming pressure of the fresh water feed constant at 2 bar.

2 The **ROCLEAN injector** has to be installed on the water output side. The injector constantly and securely doses the bottle contents to the system to be cleaned.



Model	kg		No.
ROCLEAN injector	1.1	1	100000190
Pressure regulator 2 bar	0.3	1	150000203

Cleaning and preservation with ROCLEAN

Cleaning chemicals for radiator heating systems



For cleaning incrustations and tough deposits. Suitable for all standard pipe materials. Does not stay in system. One bottle per 100 l system volume.



Cleaning chemicals for surface heating systems



For cleaning of deposits and bio films. Suitable for all standard pipe materials. Does not stay in system. One bottle per 100 l system volume.



Preservative for radiators and surface heating systems



Maintains the cleaned condition and protects the system. One bottle is sufficient for 100 l system volume.



Disinfection of drinking water systems



Does not stay in system. One bottle per 100 l system volume.



Cleaning and preservation steps:

Before cleaning	
Step 1: Mechanical cleaning	
Step 2: Chemical cleaning	
Step 3: Preserving	

Model	Color code	kg		No.
ROCLEAN injector		1.1		100000190
Pressure regulator 2 bar		0.3		150000203
Chemical cleaning:				
– Radiator heating systems (6 pcs.)	●	6.3	1	150000200
– Surface heating systems (6 pcs.)	●	6.3	1	150000201
Preservative (6 pcs.)	●	6.3	1	150000202
Disinfection (6 pcs.)	●	6.3	1	150000157

ROCAL 20 / ROMATIC 20

Decalcifying pump with flow direction change



Product profile

RANGE OF USE

For the quick decalcifying of heat exchangers, water pipes, water tanks, heat and cooling systems

KEY FEATURES

- With the help of the flow reversal (change of the direction of flow) even very hard calcifications and deposits can be loosed
- Only ROMATIC: Running time of the pump and flow reversal can be programmed, which enables comfortable operation
- Approved for fluid temperatures up to 50 °C for especially efficient decalcifying
- Constant circulation of the decalcifying chemical prevents damage that can be caused by the development of gas during decalcification

TECHNICAL DATA

Connection:	R 1/2"
Tank volume:	15 l
Power supply:	230 V 50 Hz
Motor rating:	150 W
Volume flow:	40 l / min.
Delivery height:	10 m



Fig. ROCAL 20

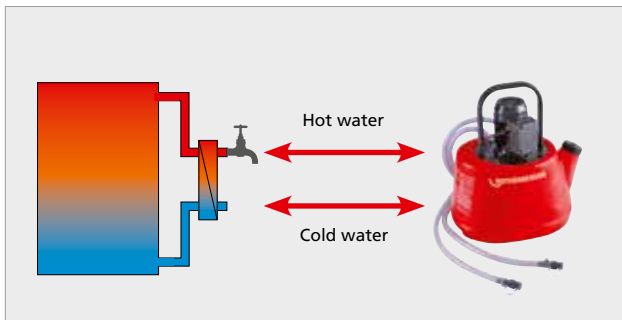
Automatic flow reversal!



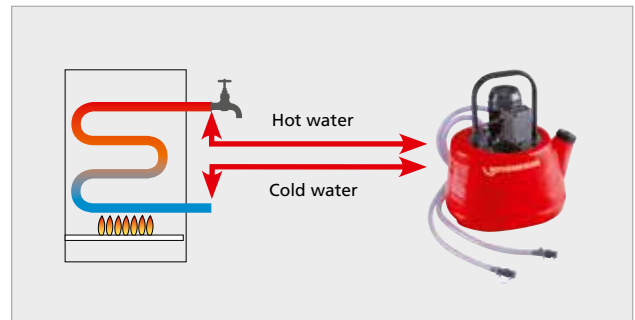
Fig. ROMATIC 20



Decalcifying of fresh water stations and external heat exchangers



Decalcifying of heat exchangers, water heaters or drinking water pipes



Scope of delivery: ROCAL 20 (No.61100) and ROMATIC 20 (No. 61190) each contain: 2x hoses with 1/2" connection (2 m long), 2 x double nipple 1/2-3/8", 2 x double nipple 1/2-3/4", 2 x double nipple 1/2-1/2", 2x double socket 3/4-3/4", 2 x reduction piece 1/2-3/4"

Model	kg	No.
ROCAL 20	6	61100
ROMATIC 20	6	61190

ACCESSORIES



Decalcifying chemical for ROCAL 20, ROMATIC 20 see 224

¹⁾ Complete terms and conditions at rothenberger.com/roservice
RO SERVICE+ only valid in participating countries

Flushing and pipe cleaning

Decalcifying

ROCAL Acid Multi / Plus

Decalcifying chemical for use with ROCAL 20, ROMATIC 20

Product profile

RANGE OF USE

ROCAL Acid Multi

For the safe decalcification of all piping systems, heat exchangers, fresh water stations and water tanks

ROCAL Acid Plus

For strong calcifications and scale build-up. Only suitable for technical systems. Not suitable for drinking water pipes.

KEY FEATURES

- With color indication. The use of the chemical effects is shown by the change of the fluid color
- Concentrate to mix with water
- With corrosion protection



No. 150000115

No. 150000116

No. 150000117



No. 61105

No. 61106

No. 150000914

	ROCAL Acid Multi	ROCAL Acid Plus
Copper	●	●
Steel	●	●
Stainless steel	●	-

● suitable - unsuitable

	ROCAL Acid Multi	ROCAL Acid Plus
Aluminium	●	-
Brass	●	-
Plastic	●	-

● suitable - unsuitable

Model	kg		No.
ROCAL Acid Multi	5	1	150000115
ROCAL Acid Multi	10	1	150000116
ROCAL Acid Multi	30		150000117

Model	kg		No.
ROCAL Acid Plus	5	1	61105
ROCAL Acid Plus	10	1	61106
ROCAL Acid Plus	25	1	150000914

11

Neutralizer powder

Neutralizes ROCAL Acid Plus / ROCAL Acid Multi

Product profile

RANGE OF USE

Use is necessary after ROCAL Acid Plus / ROCAL Acid Multi has been used. The neutralizer dissolves in water. The decalcification pump and system are flushed with this solution. The PH value in the system and pump is neutral afterwards.

Model	kg		No.
Neutralizer powder	1	1	61115
Neutralizer powder	10	1	61120



No. 61115

No. 61120

ROSOLAR PUMP / ROSOLAR PUMP PLUS



Solar filling pump

Product profile

KEY FEATURES

- A powerful centrifugal pump for rapid filling and effective flushing out and ventilation of solar plant
- Optional: robust and heat resistant (up to 90 °C) Impeller pump: Small particles of solid materials are also conveyed without difficulty. Fitted with a pressure relief valve
- Heat resistant hoses (up to 100 °C) allow safe filling and maintenance of solar plant
- A height-adjustable (76 - 110 cm) telescopic grip for space-saving storage, simple transport and good handling in tight cellars
- Well thought-through handling: The canister can easily be filled through the large opening. The shut-off valve in the bottom allows simple/uncomplicated emptying of the whole container
- Ball valves for safe removal of filling hoses without accidental spill

TECHNICAL DATA

Dimensions (H x W x D):	49 x 51 x 76 cm
Container volumes:	30 l
Hoses:	Length: 2 x 3 m Connections: 3/4"
	Heat resistant: up to 100 °C

Height-adjustable telescopic grip (76 - 110 cm)

Small and flexible if required

A generously dimensioned container opening

For easy and secure filling

Optional: A fleece filter bag

For preservation of the internal filter when flushing older plants with strong pollution

A dirt filter with sight glass

Filters residues out of the medium

Heat resistant hoses (up to 100 °C)

Safe working – also when servicing solar plant with kink protection at the hose connection

Optional: impeller pump

Small particles of solid materials are also conveyed without difficulty



11

Return flow cover with filter



Hose connection with anti-kink protection



Ball valve



Model	No.
ROSOLAR PUMP (with centrifugal pump)	1500000135
ROSOLAR PUMP PLUS (with impeller pump)	1500000136
Fleece filter bag ROSOLAR (10 pcs.)	1500001236
Return flow cover (for filter bags)	1500001235

Flushing and pipe cleaning

Pipe cleaning manual

ROPUMP SUPER PLUS

Professional force pump cleaner

The optimum introduction tool for the removal of obstructions in basins, bowls, tubs and toilets etc., using water pressure

Quick – Compact – Handy!

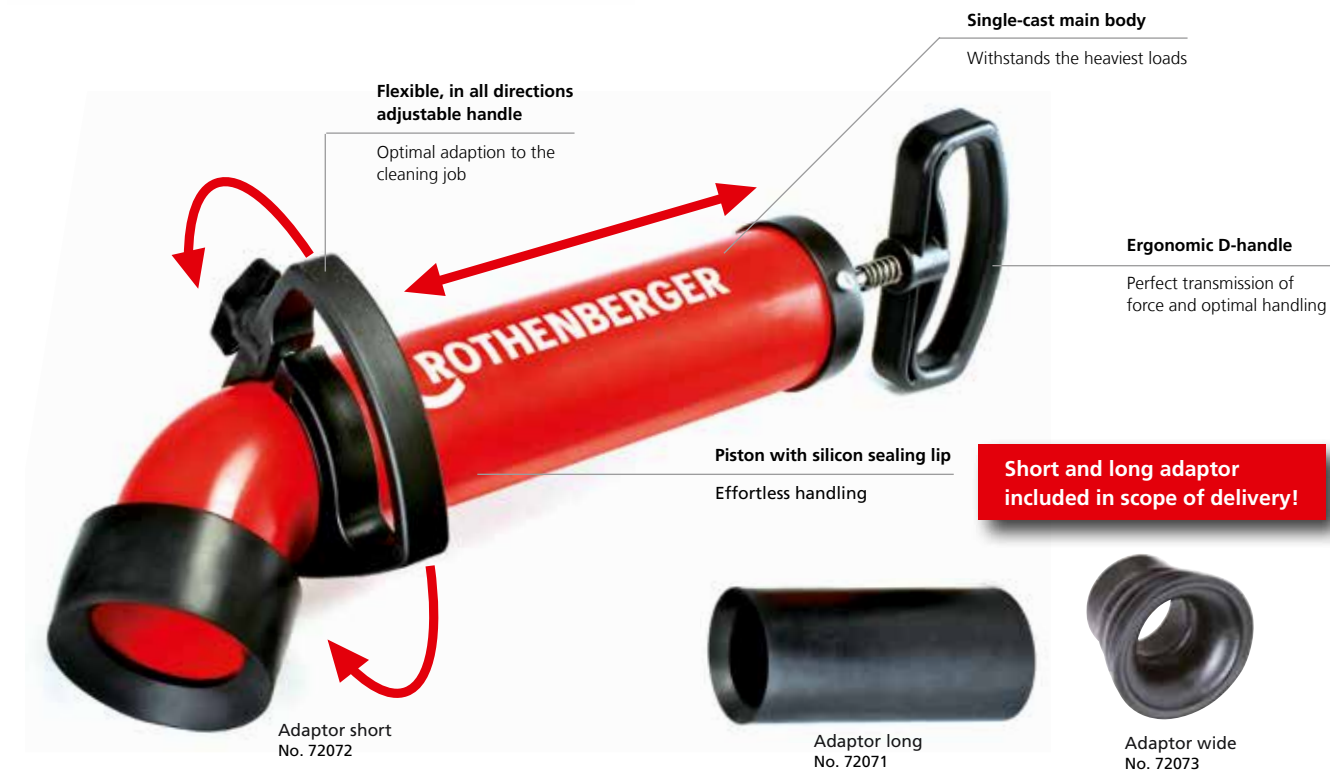
Product profile

KEY FEATURES

- Optimal adaption to the job due to adjustable handle
- Good force transmission with ergonomic handles
- Optimal sealed system and therefore high suction and pressure power with single cast main body

KEY FEATURES

- Simple handling with the perfect adaption to the drain and easy to use with ergonomic formed components



Short adaptor



Long adaptor



Model	kg	No.
ROPUMP SUPER PLUS with 2 adaptors (long, short)	2.00	072070X
ROPUMP SUPER PLUS 3 adaptors (long, short, wide) and toolbag	3.30	1000001762
Adaptor long	0.66	72071
Adaptor short	0.16	72072
Adaptor wide	0.40	72073

11

ROPUMP

Force pump cleaner according to the air-pump principle with water pressure



Dissolves obstructions in drains, basins, showers, bathtubs etc.

Product profile

KEY FEATURES

- Small and handy
- Compact and effective

Model	g	No.
ROPUMP with flexible socket	500	71991

ROSPI H+E PLUS

Professional manual and electrical drain cleaning unit

Clean and comfortable removal of obstructions in kitchen, bath, toilets or drainage openings with drain cleaning spiral

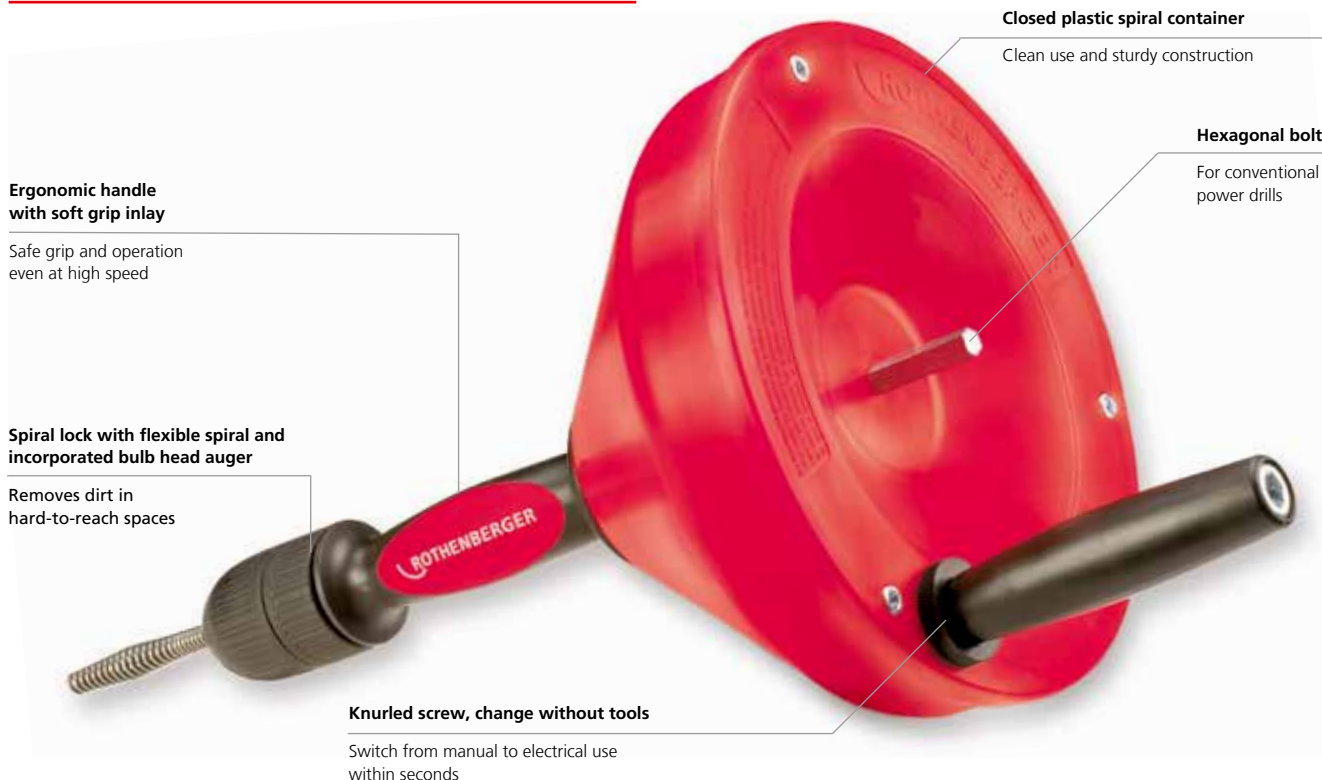
Product profile

KEY FEATURES

- Removal of sinks and siphons is not necessary
- Switch from manual to electrical use within seconds
- Secure hold even at higher speeds during drill operation
- Impact-resistant and protected from dirt contamination
- Hexagonal drive for conventional power drills

TECHNICAL DATA

Working range: 20 - 50 mm
Spiral: Ø 8 mm x 7.5 m



Electrical operation with cordless drill



Manual operation



Model		kg		No.
ROSPI 6 H+E Plus	4.5 m	1.4	1	72090
ROSPI 8 H+E Plus	7.5 m	3.5	1	72095
ROSPI 10 H+E Plus	10.0 m	4.8	1	72005

For spare spirals see 243

Flushing and pipe cleaning

Pipe cleaning manual

ROPOWER HANDY

Manual drain cleaning unit, Ø 50 - 100 mm

A universal manual drain cleaning unit for fast clearance of obstructions. The spiral permits the attachment of a wide range of ROTHENBERGER pipe cleaning tools with 16 mm couplings

KEY FEATURES

- Additional spiral cleaning effects with the use of a square spiral



Set (No. 71973) includes: ROPOWER PROFILE spiral 2.3 m without core (No. 72494), manual crank (No. 71976), safety gloves (No. H81401), separating pin (No. 72100), blade cutter Ø 25 mm (No. 72169)

Model	kg	No.
ROPOWER HANDY complete	1.7	71975
ACCESSORIES		
Manual crank	0.4	71976
ROPOWER PROFILE CABLE w/o plastic core	1.2	72494

WC-BLITZ RO-3 toilet auger

KEY FEATURES

- **Flexible use even in hard-to-reach places**
With tough cleaning bulb auger. Extendable handle and 1 m spiral length, Ø 1/2"
- **No damage to ceramic surfaces**
Angle made out of plastic

Angle with plastic protection

No damage to ceramic surfaces in the visual range



Ergonomic handle with soft grip inlet

Reliable and safe use, firm grip

T-groove coupling at No. 1500001324

Universal bulb auger

High mobility in bends

Model	kg	No.
WC-Blitz RO-3 complete with spiral	2.75	78551
WC-Blitz RO-3 with tool coupling	2.90	1500001324

Manual drain cleaner type 3 S

For pipes Ø 40 - 100 mm

Spirals Ø 13 mm x 15 m with 16 mm coupling

KEY FEATURES

- **Flexible use with a wide range of applications**
For use with all ROTHENBERGER drain cleaning tools with 16 mm couplings
- **Cleaning unit with stand**
Secure use
- **Plastic spiral drum**
Corrosion-proof and impact-resistant

Set includes (No. 72003): manual drain cleaner type 3 S (No. 72003), spirals Ø 13 mm x 15 m (No. 72016), cross-blade cutter Ø 35 mm (No. 72176) and separating pin (No. 72100)

Model	kg	No.
Manual drain cleaner type 3 S, complete	17.50	72003
Spare spiral Ø 13 mm x 15 m	7.00	72016
Cross-blade cutter Ø 35 mm	0.04	72176
Separating pin	0.01	72100

Further Ø 16 mm tools can be found on 242



Flushing and pipe cleaning

Pipe cleaning electric



ROSPIMATIC CL

Professional drain cleaning unit up to Ø 50 mm

Effective removal of obstructions in access lines with a one-of-a-kind spiral forward and reverse system without changing the rotational direction.

Product profile

KEY FEATURES

- Switch between forward and reverse under full load without the need to change the motor rotational direction
- Unit can be used with any professional cordless drill driver
- Soft stop technology for smooth run out prevents hits to user's wrist
- The spiral drive can be combined with 3 different cleaning tools for more efficient operation (optional)
- Optional guide hose prevents pollution of the working place

TECHNICAL DATA

Application range:	20 - 50 mm
Spiral with inner-core and Bulb auger:	Ø 8 mm x 7.5 m
Dimensions (without spiral):	420 x 200 x 200 mm

Locking knob with torque limit

No squeezing of the spiral



Patented feeding mechanism

Switching between forward and reverse without stopping the machine



Free-wheel clutch for hexagonal take-up

Soft roll-out of the machine without hit to user's wrist.

Compact design without power unit

Little required space

Hexagonal take-up for battery drill

Dual use for customer's own drill



With bulb-auger



With coupling for various tools



With flexible guide hose



Set (No. 1000002299) includes: ROSPIMATIC CL set incl. spiral 8 mm x 7.5 m with bulb head (No. 72413), spiral 8 mm x 7.5 m with coupling (No. 72425), cross-blade auger (No. 72765) and separating key (No. 72102)

Set (No. 72942) includes: blade cutter (No. 72764), cross-blade cutter (No. 72765), ball head cutter (No. 72766), separating pin (No. 72102)

Model	No.
ROSPIMATIC CL basic unit incl. 8 mm / 7,5 m spiral	1000002298
ROSPIMATIC CL set, w. 2nd spiral+cross-blade auger	1000002299
Spiral 8 mm x 7,5 m, w. bulb auger and steel core	72413
Spiral 8 mm x 7,5 m, with coupling and core	72425
Tool set 8 mm (4 pcs.)	72942
Protection hose f. ROSPIMATIC CL	72542

Easy connection to professional cordless drill driver



For additional accessories see 240

¹⁾ Complete terms and conditions at rothenberger.com/roservice
RO SERVICE+ only valid in participating countries

Flushing and pipe cleaning

Pipe cleaning electric



Model		230 V
R 550 w/ guide hose	16.0	72686
Tool sets and accessories starting on 238		

R 550

Drain cleaning machine for pipe Ø 20 - 100 mm

Reliable, high-performance drain cleaning machine with a variety of general purpose maintenance uses

Product profile

APPLICATION AREA

Especially light, compact and handy design: Ideal for the universal service use by pipe obstructions in connecting pipes from wash basins, toilets, sewage pipes, floor drains and roof drainage

KEY FEATURES

- Extremely light
- Direct attachment of 16 mm spirals
- Maximum working length 40 m, with Ø 16 mm S-spiral

TECHNICAL DATA

For pipe diameters:	Ø 20 - 100 mm
Direct attachment:	Ø 16 mm spirals
Max. working length:	40 m with Ø 16 mm S-spirals
Rating:	440 W (power input)
Voltage:	230 / 110 / 115 V, 50 Hz
Speed:	583 rpm, RH and LH drive
Weight:	16.0 kg

11



Model		230 V
R 600 w/ guide hose	20.9	72687
Tool sets and accessories starting on 238		

R 600

Drain cleaning machine for pipe Ø 20 - 150 mm

For installation and maintenance work in hospitals and municipal facilities

Product profile

APPLICATION AREA

Universal use both indoors and outdoors: The powerful motor works reliably even against stubborn obstructions. A wide range of accessories is available

KEY FEATURES

- Direct up take of 16 mm and 22 mm spirals
- Optional Ø 8 and 10 mm with adaptor magazine possible
- Maximum working length 50 m, with Ø 16 mm S-spirals
- Maximum working length 60 m, with Ø 22 mm S-spirals

TECHNICAL DATA

For pipe diameters:	Ø 20 - 150 mm
With direct attachment:	Ø 22 and 16 mm spirals
With adaptor magazine:	Ø 8 and 10 mm
Max. working length:	60 m with Ø 22 mm S-spirals 50 m with Ø 16 mm S-spirals 10 m with Ø 8 and 10 mm spirals
Rating:	690 W (power input)
Voltage:	230 / 110 / 115 V, 50 Hz
Speed:	467 rpm, RH and LH drive
Weight:	20.9 kg

Flushing and pipe cleaning

Pipe cleaning electric

R 600 VarioClean

Drain cleaning machine for pipe Ø 20 - 150 mm

For working in service areas, hospitals and non-municipal facilities, especially in areas without power supply.



Product profile

APPLICATION AREA

Ideal for plumbers, janitors and pipe cleaners for the effective and flexible removal of blockages in sewage pipes up to 150mm in diameter. Particularly suitable for use in areas without power supply.

KEY FEATURES

- CAS-battery system: For wireless working and increased electrical safety
- VarioClean Electronic: Three speed levels for unblocking, cleaning and clean spinning. Optimal adaptation possibilities to the type of blockage.

KEY FEATURES

- Suitable for indoor and outdoor use
- Compact design and low weight

TECHNICAL DATA

Working range:	Ø 20 - 150 mm
Max. working length:	50 m (with 16 mm spiral) 60 m (with 22 mm spiral)
Speed:	427/527/614 rpm
Product dimension:	430 x 250 x 480 mm

VarioClean-Electronic

Optimum adaptation to the type of blockage for faster work progress

LED site light

Perfect illumination of the work area

Versatile application

70 tools with 5 different types of spirals

Spiral holder/Spiral separator

Safe insert and separation of new spiral segments

Multigrip Center-Lock clamping system

For spiral sizes 16 and 22 mm
Automatic adaption to all sizes

18V CAS-battery system

Powerful 18V battery for a running time up to 50 minutes

Brushless Motor

For wear-free work and longer machine life



Optimum adjustment options for unblocking – cleaning – clean spinning



Plug-free 18V Power with the CAS-battery system



Model



No.

R600 VarioClean baretool	13.0	1	1000003345
R600 VarioClean baretool with battery Li-HD, 8.0Ah 18V and battery charger	18.7	1	1000003372
R600 VarioClean with DuraFlex SMK spiral-/tool set 16+22 mm and battery 8.0Ah 18V incl. battery charger	50.7	1	1000003346

For spare spirals see 249

¹⁾ Complete terms and conditions at rothenberger.com/roservice

RO SERVICE+ only valid in participating countries

²⁾ More information at cordless-alliance-system.com

Flushing and pipe cleaning

Pipe cleaning electric

R 650

Drain cleaning machine for pipe Ø 20 - 150 mm

For professional mobile drain cleaning. Compact, robust and powerful, even by the toughest pipe obstructions



Product profile

APPLICATION AREA

Perfectly suited for rough use and in extreme working conditions: Quiet operation and powerful cleaning action, even when cutting through roots or grinding out cement and lime deposits

KEY FEATURES

- Double motor performance (cp. R 600)
- Flexible with drive lever that can be fitted on the side
- Direct up take of 22 mm and 16 mm spirals
- Optional Ø 8 and 10 mm with adaptor magazine possible
- Maximum working length 65 m, with Ø 22 mm S-spiral

TECHNICAL DATA

For pipe diameters:	Ø 20 - 150 mm
Direct attachment:	Ø 22 and 16 mm spirals
With adaptor magazine:	Ø 8 mm and 10 mm
Max. working length:	65 m with Ø 22 mm S-spirals 55 m with Ø 16 mm S-spirals 10 m with Ø 8 and 10 mm spirals
Rating:	1,350 W (power input)
Voltage:	230 V, 50 Hz
Speed:	623 rpm, RH and LH drive
Weight:	22.8 kg



Drive lever can be fitted on the side

Flexible use

Model	22.8	230 V
R 650 w/ guide hose	22.8	72688
Tool sets and accessories starting on 238		

R 750

Drain cleaning machine for pipe Ø 20 - 200 mm

For professional mobile drain cleaning. Compact, robust and powerful, even by the toughest pipe obstructions



Product profile

APPLICATION AREA

Perfectly suited for the cleaning of domestic connections and main pipes: Quiet operation and powerful cleaning action. Usable for such as chain spinning, grinding and cutting roots

KEY FEATURES

- Drive lever can be rotated (180°), locked and used as a handle for easy wheeling
- Direct up take of 32 mm and 22 mm
- Optional Ø 16 mm with clutch jaw possible
- Maximum working length 80 m, with Ø 32 mm S-spirals

TECHNICAL DATA

For pipe diameters:	Ø 20 - 200 mm
With direct attachment:	Ø 32 and 22 mm spirals
With clutch jaw:	Ø 16 mm
Max. working length:	80 m with Ø 32 mm S-spirals 70 m with Ø 22 mm S-spirals 55 m with Ø 16 mm S-spirals
Rating:	1,400 W (power input)
Voltage:	230 V, 50 Hz
Speed:	467 rpm, RH and LH drive
Weight:	33.5 kg



Full rubber transport wheels

Comfortable transport, high mobility and a secure stand

Model	33.5	230 V
R 750 w/ guide hose	33.5	72689
Tool sets and accessories starting on 238		

Flushing and pipe cleaning

Pipe cleaning electric

RODRUM S

Drum drain cleaning machine with automatic spiral feed. For pipes from Ø 40 - 100 mm. Perfectly suited for use in public and commercial buildings.

Product profile

KEY FEATURES

- Clean and discreet use
- Easy handling due to automatic spiral feeding and retrieving
- New feeding unit for direct pressure relief by release of the feeding handle
- Machine works with Ø 10 and Ø 13 mm spirals

KEY FEATURES

- **Flexible use:**
Drum interchangeable for different pipe diameters
- **Easy to use:**
Feeding and pressure relief with single handle
- **Clean:**
Spiral in detachable drum

Interchangeable drum

Fast change between Ø 10 mm and Ø 13 mm spirals, easy to carry

Spiral protection

Fast tension relief from the spiral to prevent damage just by releasing the lever

Cleanout slots and drain plug

Easy and fast cleaning of the drum

Rubber feet

No damage to the floor

2-in-1 feeding unit

Suitable for Ø 10 mm and Ø 13 mm spirals



Flushing and pipe cleaning

Pipe cleaning electric



APPLICATION AREA

- Compact construction: Ideal for service deployment to unblock pipes in connecting pipes of wash basins, toilets, drainage pipes, floor drainage
- On retraction the dirty spiral moves back into the spiral drum. Due to its clean and discrete operation, the machine is best suited for SHK-companies and their services in private houses, hospitals and clinics, gastronomy and hotels, Facility Management and public buildings

TECHNICAL DATA

Working range/pipe diameter: Ø 40 - 100 mm
Max. working length: 10 m (with 10 mm Spirals)
 15 m (with 13 mm Spirals)
Power (input): 440 W
Speed (drum): 300 rpm
Product dimensions: 58 x 33 x 39 cm

Cleaning of floor drain with 13 mm spiral



Convenient transport thanks to detachable drum



Interchangeable drum for different working ranges



11

Model	kg	230 V 50 Hz
RODRUM S 10 EU	18.9	1000001256
RODRUM S 13 EU with tool kit	25.7	1000001257
Spiral 13 mm x 15 m with reinforced wire		72016

Set (No. 1000001256) includes: RODRUM S 10, guide hose (No. 1300002581), spiral guide gloves (No. 1500000439)

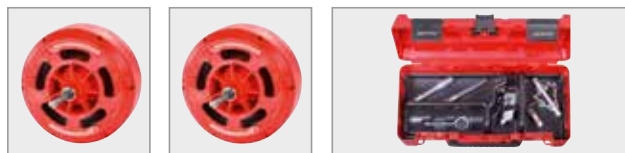
Set (No. 1000001257) includes: RODRUM S 13, spiral guide gloves (No. 1500000439), chain spinning head (No. 072185F), cross blade cutter (No. 72176), forked cutter (No. 72164), bulb auger (No. 72163), retrieving auger (No. 72162), straight auger (No. 72161), separating pin (No. 72100), guide hose (No. 1300002581), ROCASE (No. 1300003334) with inlay (No. 1300003372)

Set (No. 1000001308) includes: chain spinning head (No. 072185F), cross blade cutter (No. 72176), forked cutter (No. 72164), bulb auger (No. 72163), retrieving auger (No. 72162), straight auger (No. 72161), separating pin (No. 72100), ROCASE (No. 1300003334) with inlay (No. 1300003372)

ACCESSORIES

Model	kg	No.
RODRUM S 10 Drum	5.5	1000001275
RODRUM S 13 Drum	11.4	1000001276
Tool kit 16 mm	5.5	1000001308

Spirals, Drain cleaning tools 241



RODRUM VarioClean

The RODRUM VarioClean is a compact drum machine for removing blockages in pipes from 40-100 mm diameter. Through its clean and discrete work it is ideally suited for sanitary businesses, janitors, drain cleaners or for use in households, catering and hotels or public buildings because the dirty spiral moves into the drum during the return.



Product profile

APPLICATION AREA

For the removal of blockages in sewage pipes of 40 - 100 mm in diameter. 10 mm spiral for pipe diameters from 40 - 70 mm
13 mm spiral for pipe diameters from 50 - 100 mm

KEY FEATURES

- CAS-battery system: For wireless working and increased electrical safety
- VarioClean Electronic: Three speed levels for unblocking, cleaning and clean spinning. Optimal adaptation possibilities to the type of blockage.

KEY FEATURES

- VarioClean Electronic: Prevents the drum from running on for a long time
- DuraFlex spirals: Especially flexible spirals with galvanisation. Optimized for the usage with the battery-powered RODRUM VarioClean

TECHNICAL DATA

Working range:	Ø 40 - 100 mm
Max. working length:	10 m (with 10 mm spiral) 15 m (with 13 mm spiral)
Speed:	275/340/395 rpm
Product dimension:	430 x 250 x 395 mm



11

Model	kg		No.
RODRUM VarioClean with DuraFlex spiral 13 mm/15 m	21.8	1	1000003347
RODRUM VarioClean with DuraFlex spiral 13 mm/15 m incl. battery Li-HD 8.0Ah 18V, battery charger	26.6	1	1000003371
RODRUM VarioClean with DuraFlex spiral 13 mm/15 m, tool set 16 mm, battery Li-HD 8.0Ah 18V, battery charger	29.0	1	1000003348

ACCESSORIES

Model	kg		No.
DuraFlex spiral drum, 13 mm/15 m	12.5	1	1500003708
DuraFlex spiral 13 mm/15 m	10.0	1	1500003706
DuraFlex spiral 10 mm/10 m	4.0	1	1500003707

For spare spirals see 249

¹⁾ Complete terms and conditions at rothenberger.com/roservice
RO SERVICE+ only valid in participating countries

²⁾ More information at cordless-alliance-system.com

Flushing and pipe cleaning

Pipe cleaning electric

RODRUM M and L

Drum drain cleaning machine with automatic spiral feed. For pipes from Ø 70 - 250 mm. Perfectly suited for use in public and commercial buildings as well as house connection pipes.



Product profile

KEY FEATURES

- Interchangeable drums for quick and easy adaption to different pipe diameters without use of any tool
- Clean and discreet use
- Easy handling due to automatic spiral feeding and retrieving
- Spiral protection due to direct pressure relief by release of the lever
- Machine works with 13, 16, 20 mm spirals

RANGE OF USE

- RODRUM M and L is a drum drain cleaning machine with automatic spiral feed for removal of blockages in pipes from Ø 70-250 mm.
- Due to the interchangeable drums the machine can be adapted to different pipe diameters quickly without usage of any tools
- The dirty spiral runs back into the drum and keeps the surrounding free of dirt
- The clean and discrete way of working is ideal for Plumbers, facility managers, drain cleaners for jobs in private households, as well as public buildings like hotels or restaurants

TECHNICAL DATA

Working range/pipe diameter:	Ø 70 - 250 mm
Power (input):	620 W
Speed (drum):	270 r/min.
Product dimensions:	77 x 56 x 87 cm

Loading device

Ergonomic loading of the machine



Spiral protection

Fast tension relief from the spiral to prevent damage just by releasing the lever

Interchangeable drum

Fast change between Ø 13, 16, 20 mm spirals

Cleaning slots

Easy and fast cleaning of the drum

3-in-1 feeding unit

No retrofitting necessary for different spiral diameters

Interchangeable drums for adaption of the working range



Rubber feed

No damage of the floor

Model	Spiral-Ø	max. L m	⌀ mm
S 10	10 mm x 10 m	10	bis 50
S 13	13 mm x 15 m	15	70 - 100
M 13	13 mm x 15 m	30	70 - 100
M 16	16 mm x 15 m	45	75 - 125
L 16	16 mm x 30 m	45	75 - 125
L 20	20 mm x 20 m	60	125 - 250

Model		kg	230 V 50 Hz
RODRUM M 13	spirals 13 mm x 15 m, incl. 16 mm tool kit	45.5	1000001711
RODRUM M 16	spirals 16 mm x 15 m, incl. 16 mm tool kit	50.2	1000001712
RODRUM L 16	spirals 16 mm x 15 m, incl. 16 mm tool kit	51.9	1000001713
RODRUM L 20	spirals 20 mm x 20 m, incl. 20 mm tool kit	68.0	1000001714

Flushing and pipe cleaning

Pipe cleaning electric

RODRUM M and L drums

Interchangeable spiral drums for quick and easy adaption of the machine to different pipe diameters or for extension of the spiral length.



No. 1000001730



No. 1000001728

Model	kg	No.
RODRUM drum M 13 incl. spiral 13 mm x 15 m	14.5	1000001727
RODRUM drum M 16 incl. spiral 16 mm x 15 m	19.0	1000001728
RODRUM drum L 16 incl. 2x spirals 16 mm x 15 m	38.7	1000001729
RODRUM drum L 20 incl. spiral 20 mm x 20 m	36.8	1000001730

ACCESSORIES

Model	kg	No.
Straight auger, 20 mm*	0.32	1500002253
Funnel auger, 20 mm*	0.55	1500002254
Bulb auger, 20 mm*	0.40	1500002255
Retrieving auger, 20 mm*	0.12	1500002256
Peak-head auger, 20 mm*	0.40	1500002257
Cross-blade cutter 50, 20 mm*	0.16	1500002258
Cross-blade cutter 65, 20 mm*	0.23	1500002259
Cross-blade cutter 90, 20 mm*	0.39	1500002260
Chain-spinning head, 4 chains, 20 mm*	0.30	1500002261
Forked cutter 60, 20 mm*	0.10	1500002262

* all 20 mm augers with square coupling

Model	kg	No.
Forked cutter 80, 20 mm*	0.15	1500002263
Forked cutter 100, 20 mm*	0.20	1500002264
Two-way root cutter 65, 20 mm*	0.39	1500002265
Two-way root cutter 90, 20 mm*	0.46	1500002266
Adaptor, square-coupling to 22 mm T-coupling	0.25	1500002267
Spiral 13x15 with inner core	10.8	1500002271
Spiral 16x15 with inner core	15.5	72918
Spiral 20 mm x 20 m w. inner core and square coupling	33.5	1500002268
RODRUM tool kit 16 mm		1000001731
RODRUM tool kit 20 mm		1000001732



No. 1500002267



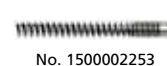
No. 1500002254



No. 1500002261



No. 1500002257



No. 1500002253



No. 1500002266



No. 1500002255



No. 1500002258



No. 1500002256



No. 1500002263



No. 1000001731



No. 1000001732

Set (No. 1000001731) includes: ROCASE (No. 1300003334) with inlay (No. 1300003372), chain-spinning head (No. 072185F), cross-blade cutter (No. 72176), forked cutter (No. 72164), bulb auger (No. 72163), retrieving auger (No. 72162), straight auger (No. 72161), separating key (No. 72100)

Set (No. 1000001732) includes: ROCASE (No. 1300003334) with inlay (No. 1300003372), bulb auger (No. 1500002255), cross-blade cutter (No. 1500002259), forked cutter (No. 1500002263), separating key (No. 72101)

11

Loading device



Easy transport due to stair capable chassis



Cleaning of a down pipe with 16 mm spiral



Flushing and pipe cleaning

Accessories pipe cleaning electric



No. 72538



No. 72536



No. 72638




No. 72666



No. 72563

Clutch jaws

For machine type	For spirals-Ø		No.
R 550			
(from serial No. 411542)	16 mm	0.1	72538
(up to serial No. 411541)	16 mm	0.1	72536
R 600/650			
(from serial No. 409001)	16 and 22 mm	0.3	72638
(up to serial No. 409000)	16 and 22 mm	0.3	72666
R 750	22 and 32 mm	0.4	72563
R 80/100 SP/R140 B	22 mm	0.4	72561
R 80/100 SP	32 mm	0.3	72562




No. 72514, No. 72515




Adaptor magazines

- Clean, safe storage of 8 and 10 mm spirals
- Impact-resistant container with clutch jaws and precision clutch

For machine type	For spiral-Ø	max. Spiral length		No.
R 600/650	8 mm	10 m	1.8	72514
R 600/650	10 mm	10 m	1.8	72515



Clutch jaw for R 750

For machine type	For spirals-Ø		No.
R 750	16 mm	0.3	72915

Ensures safe, kink-free spiral feed



No. 72541




No. 72559

With precision quick coupling

Spiral guide hoses

- Prevents contamination and damage


Model	for machine type	for spiral-Ø	Length		No.
FS 16	R 550 / RODRUM S	16 mm	2 m	1.1	72540
FS 22	R 600 / 650	22 mm	4 m	2.8	72541
FS 32	R 750 / 80 / 100 SP	32 mm	4 m	4.1	72559

Ideal working height



Tripod stand

- Collapsible and galvanised
- Provides an ideal working height of the drain cleaning machine, for example: inspection holes in downpipes
- Spiral retrieving device

For machine type		No.
R 550 - R 600 - R 650 - R 750	3.0	58182

Spiral retrieving device

- Safe feeding / retrieving of spirals in downpipes
- Suitable for all Ø 22 and 32 mm open-wound spirals
- Suitable as pusher unit for difficult obstructions
- Also suitable as adaptor for third-party equipment without problems
- With water supply connection (two 1" threaded couplings)
- Socket for tripod stand

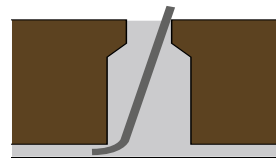


Model		kg	No.
Spiral retrieving device		3.7	72135

Telescoping guide tubes

- No twisting: For safe spiral guidance in manholes and manhole covers

Model	Extended length m	Type	kg	No.
For spirals Ø 16, 22 mm	1.4 - 2.3	2 pcs.	3.0	72130



ROWONAL care and rust remover

- For cleaning, preservation and protection of spirals, couplings and tools
- For cleaning, rust-removal



No. 72142

Model	Contents	g	No.
Spray can	0.2 l	220	72142
Plastic canister	5.0 l	5,100	72140

Spiral guide gloves

- For safe grasping and guiding of cleaning spirals

Guide gloves, leather:

- Full leather with short cuff
- Robust and comfortable, inner glove surface studded
- Only to be used with hygiene glove



No. 1500000439



No. 72120 / 72121

Model	g	No.
Guide gloves left, leather	190	72120
Guide gloves right, leather	190	72121
Guide gloves (pair), rubber	160	1500000439

Separating pin

- For disconnecting spirals and spiral tools

Model		g	No.
For spirals / tools with Ø 16 mm		20	72100
For spirals / tools with Ø 22 and 32 mm		30	72101
For spirals / tools with Ø 8 mm		15	72102



No. 72100



No. 72101

Spiral baskets

- Safe storage combined with convenient transport
- Perfectly suited for cleaning and preservation

Model	Spiral length max.	kg	No.
For spirals / tools w/ Ø 16 mm	34.5 m	1.3	72110
For spirals / tools w/ Ø 22 mm	22.5 m	1.6	72112
For spirals / tools w/ Ø 22, 32 mm	22.5 m	2.3	72111



No. 72110



No. 72111



No. 72112

Flushing and pipe cleaning

Pipe cleaning spirals

ROTHENBERGER high-performance drain cleaning spirals

For the toughest demands during continuous operation

Product profile

KEY FEATURES

- **Bevelled lead-ins on the T-groove coupling**
- Quick, trouble-free coupling even when wearing gloves
- **For the toughest demands even during continuous operation**
Different wire gauge can be chosen depending on use, high material characteristics, perfected production process
- **Maximum spring tension with high elasticity and flexibility**
Specially hardening process

KEY FEATURES

- **Optimum high torque transmission**
Tightly wound spiral with short pitch
- **Increased spiral tension when machine turns clockwise and depending on the resistance of the obstruction**
Professional left-handed wound spiral

TECHNICAL DATA

Manufactured from quality spring steel, type C DIN EN 10270-1
Material No. 1.1200

Specially hardened and tempered

Safety T-groove coupling system with NIROSTA- pressure pin locking mechanism

Spring mounted NIROSTA pressure pin with NIROSTA spring

ROTHENBERGER locking

With locking



Coupling with 100% surface pressure

Self locking connection of spiral and coupling: With increased stress on the spiral, the torque pressure on the spiral end is increased and is transferred with 100% surface coverage onto the coupling.

Sufficient connecting coil

Spare couplings can be mounted easily



Various wire gauges

Flexible, depending on use

Insertion taper

Simple coupling of spirals and tools



ROPOWER profile cable

Additional cleaning effect with the squared profile



Plastic core

Spiral won't clog with dirt



T-groove made of Nirosta steel

Long lasting and high functional safety with the high-quality coupling design

Spiral / type	Short distance many bends	Long distance straight run	No clogging of the spiral with dirt	Additional cleaning power
Standard spiral	●	○	○	○
SMK-spiral	●	○	●	○
S-spiral	○	●	○	○
S-SMK-spiral	○	●	●	○
ROPOWER profile	○	●	●	●

○ not suitable ● suitable

ROPOWER profile cable

Spiral with special galvanized wire shape

KEY FEATURES

- Squared spiral wire profile (DIN EN 10270-1)
Additional cleaning effect on pipe wall
- Plastic core
No clogging of the spiral with dirt
- Especially suitable for working over long distances



Profile edge

50% more cleaning power
when used with the spiral tools

mm	Core	Inch	L m	kg	No.
16	●	5/8"	2.3	1.3	72490

Safety T-groove couplings can be found on 249

SMK-spirals

- Flexible spiral, for cleaning jobs with short distances with a succession of pipe bends
- Additional protection of the spiral from clogging with the plastic core



mm	Inch	L m	Wire thickness Ø mm	R/K Type	kg	No.
16	5/8"	2.3	3.0	C 8	1.24	72433
22	7/8"	4.5	4.5	C 10	4.64	72442
32	1.1/4"	4.5	5.0	C 11	7.63	72452

Safety T-groove couplings can be found on 249

S-SMK-spirals

- Very stable spiral with increased wire diameter for long distances and less bends
- High rigidity, suitable for demanding work, such as root cutting, milling
- Additional protection of the spiral from clogging with the plastic core



mm	Inch	L m	Wire thickness Ø mm	R/K Type	kg	No.
16	5/8"	2.3	3.5	E 8	1.30	72435
22	7/8"	4.5	5.0	E 10	4.78	72444
32	1.1/4"	4.5	6.0	E 11	7.85	72455

Safety T-groove couplings can be found on 249

Standard spirals

- Flexible spiral, for cleaning jobs with short distances with a succession of pipe bends



mm	Inch	L m	Wire thickness Ø mm	R/K Type	kg	No.
16	5/8"	2.3	3.0	C 8	1.05	72431
22	7/8"	4.5	4.5	C 10	3.98	72441
32	1.1/4"	4.5	5.0	C 11	6.29	72451

Safety T-groove couplings can be found on 249

S-spirals

- Very stable spiral with increased wire diameter for long distances and less bends
- High rigidity, suitable for demanding work, such as root cutting, milling



mm	Inch	L m	Wire thickness Ø mm	R/K Type	kg	No.
16	5/8"	2.3	3.5	E 8	3.00	72428
22	7/8"	4.5	5.0	E 10	4.18	72443
32	1.1/4"	4.5	6.0	E 11	6.80	72453

Safety T-groove couplings can be found on 249

DuraFlex spirals

- Very light and flexible spirals, optimal for use with the battery-operated R600
- VarioClean Zinc plating for extended service life



Model	kg		No.
DuraFlex SMK spiral, 16 mm/5/8"	0.8	1	1500003703
DuraFlex SMK spiral, 22 mm/7/8"	3.8	1	1500003704

Safety T-groove couplings can be found on 249

Drain cleaning tools

Examples of use

Tool expertise from ROTHENBERGER

Application areas for ROTHENBERGER high-performance drain cleaning tools with T-groove secure couplings

Suitable for all ROTHENBERGER drain cleaning spirals with

- Ø 16 mm - 5/8"
- Ø 22 mm - 7/8"
- Ø 32 mm - 1.1/4"

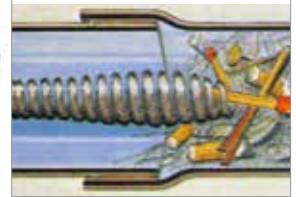
See the following pages for more information on professional tools in various versions and dimensions for loosening obstructions and cleaning drains

Bulb auger

243



The most common tool for cleaning pipes and drains with tight or multiple bends

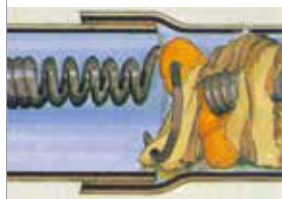


Retrieving auger

243



Special tool for retrieving objects from the pipe, e.g. textiles, spirals or tools

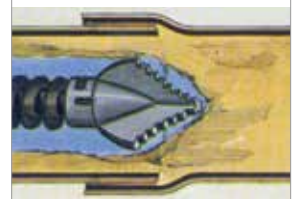


Cross-blade cutter, serrated

244



Special tool for opening up solidified pipe obstructions

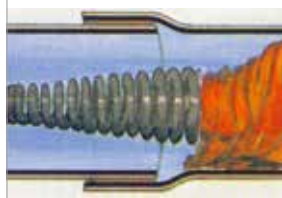


Funnel auger

243



Tool for removing, opening or retrieving obstructions caused by, e.g. textiles

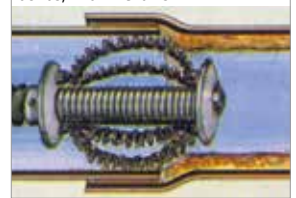


Chain-spinning head with spikes

245



For concrete, cast iron and ceramic pipes. Intensive action. Without rings = for tight pipe bends, with 3 chains



Spade head cutter

244



Ideally suited for slit or sludge deposits in pipes, and as a follow-up tool



Carbide-tipped cutters

246



This carbide-tipped tool is used to remove the hardest obstructions such as cement, urine and water scale etc.

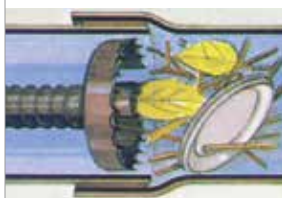


Spiral sawtooth cutter

244



Special tool for chopping up small roots and other material that have become caught in the pipe



Two-way root cutter

246

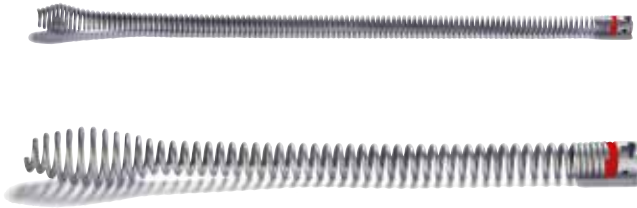





Special tool for cutting roots in both directions. Also suitable for solid materials



Bulb auger, long

- With the longer, more flexible range the bulb auger is considerably more flexible in curves. Pipe from Ø 40 mm






Coupling mm / Inch	 mm	 mm	Working range mm	 g	No.
16 / 5/8"	28	500	40 - 75	220	72158
22 / 7/8"	40	500	50 - 100	464	72208

Straight auger

- Standard tool for investigating the nature of an obstruction
- For piercing or drilling through obstructions caused by textiles, paper, cellulose materials, kitchen refuse etc.
- For removing samples to determine a suitable clearing tool






Coupling mm / Inch	 mm	 mm	Working range mm	 g	No.
16 / 5/8"	16	110	40 - 75	60	72161
22 / 7/8"	22	210	75 - 100	170	72221
32 / 1.1/4"	32	220	100 - 250	350	72321

Funnel auger

- For removing or opening up obstructions caused by textiles or paper
- Large grasping ability can also be used to retrieve spirals from drains






Coupling mm / Inch	 mm	 mm	Working range mm	 g	No.
16 / 5/8"	32	110	50 - 100	80	72165
22 / 7/8"	55	185	110 - 150	280	72222
32 / 1.1/4"	60	195	100 - 250	500	72322

Bulb Auger, short

- Suitable for tight pipe bends
- Standard, highly flexible tool for clearing light textile and paper obstructions






Coupling mm / Inch	 mm	 mm	Working range mm	 g	No.
16 / 5/8"	28	115	40 - 75	70	72163
22 / 7/8"	40	180	75 - 100	220	72263
32 / 1.1/4"	50	220	75 - 250	490	72363

Retrieving auger

- Special tool designed with a claw for retrieving textiles, tools, spirals etc.






Coupling mm / Inch	 mm	 mm	Working range mm	 g	No.
16 / 5/8"	35	55	50 - 75	35	72162
22 / 7/8"	45	100	75 - 150	110	72203
32 / 1.1/4"	65	125	75 - 250	240	72325

Drop-head auger

- Ideal for particularly tight pipe bends, branches and small-diameter drain downpipes



Coupling mm / Inch	 mm	 mm	Working range mm	 g	No.
16 / 5/8"	24	83	50 - 75	60	72159
22 / 7/8"	37	125	60 - 100	180	72264

Flushing and pipe cleaning

Drain cleaning tools

Hardened spring steel blades!






No. 72154



No. 72164

Four-blade cutter

- For cutting through and removing tough obstructions
- For the removal of sludge deposits
- Ideal with S-spirals




Coupling mm / Inch	 mm	 mm	Working range mm	 g	No.
16 / 5/8"	40	40	50 - 75	30	72154
16 / 5/8"	30	40	50 - 75	20	72164



No. 72234

- Standard tool for removing grease and other soft deposits, e.g. soap accumulations

Grease cutter




Coupling mm / Inch	 mm	 mm	Working range mm	 g	No.
16 / 5/8"	25	35	40 - 75	30	72169
16 / 5/8"	35	45	50 - 75	40	72170
16 / 5/8"	45	56	60 - 100	50	72171
22 / 7/8"	45	60	60 - 125	80	72234



No. 72261

Spade head cutter

- Curved special tool for silt and sludge deposits




Coupling mm / Inch	 mm	 mm	Working range mm	 g	No.
22 / 7/8"	65	65	100 - 150	150	72261
32 / 1.1/4"	65	70	100 - 150	250	72360



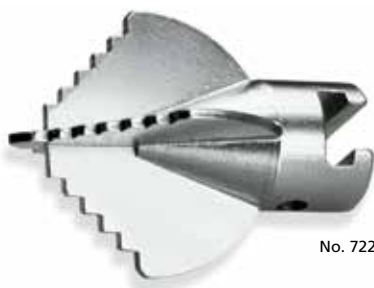
No. 72229

Spiral sawtooth cutter

- Special tool for chopping up small roots, branches and other materials
- Not suitable for plastic pipes!

Coupling mm / Inch	 mm	 mm	Working range mm	 g	No.
16 / 5/8"	35	25	50 - 75	40	72166
22 / 7/8"	45	40	75 - 100	100	72229
32 / 1.1/4"	65	55	75 - 100	210	72329




- Used for textile or sludge obstructions!
- Hardened, break-proof, spring steel blades!
- Recommended for use with S or SMK-spirals!



No. 72275

Cross-blade cutter, serrated

- Powerful combination tool for grinding up and removing solidified obstructions
- For coarse removal of incrustations
- As preparatory tool for chain spinning

Coupling mm / Inch	 mm	 mm	Working range mm	 g	No.
16 / 5/8"	25	35	50 - 75	30	72175
16 / 5/8"	35	45	50 - 75	40	72176
16 / 5/8"	45	56	75 - 100	65	72177
16 / 5/8"	55	60	100 - 125	80	72178
22 / 7/8"	45	60	100 - 125	90	72275
22 / 7/8"	65	60	100 - 150	190	72276
22 / 7/8"	75	80	100 - 150	220	72277
32 / 1.1/4"	65	70	100 - 150	260	72375
32 / 1.1/4"	90	100	125 - 200	490	72376
32 / 1.1/4"	115	120	150 - 250	640	72377

Chain-spinning heads

Without ring, with smooth chain

KEY FEATURES

- For cleaning greasy and incrustated pipes
- Surface-preserving cleaning of ceramic and plastic pipes
- Without ring: improved manoeuvrability in bends






No. 72284

Improved mobility!



No. 72289

Chain-spinning heads without ring and without spikes

Coupling mm / Inch	 mm	 mm	Working range mm	 g	No.
Without ring, with 2 chains					
16 / 5/8"	30	105	50 - 125	120	072185F
16 / 5/8"	30	155	100 - 125	160	72185
22 / 7/8"	50	170	100 - 150	530	72284
Without ring, with 4 chains					
16 / 5/8"	40	155	60 - 125	270	72187
22 / 7/8"	60	170	80 - 130	710	72289

Chain-spinning heads with spikes

KEY FEATURES

- Intensive cleaning action
- Ideal for concrete and cast iron pipes
- Reduces the risk of renewed obstructions
- Perfectly suitable for down pipes
- **With ring:**
for better centering in horizontal pipe runs
- **Without ring:**
Improved mobility in bends






No. 72286

Ideal for final cleaning!

Better alignment in horizontal pipe position!

Chain-spinning heads with ring and spikes




Coupling mm / Inch	 mm	 mm	Working range mm	 g	No.
22 / 7/8"	65	170	100 - 125	1,060	72285
22 / 7/8"	75	170	100 - 150	1,110	72286
32 / 1.1/4"	75	220	100 - 125	1,700	72341



No. 72278

For better curve manoeuvrability!

Without ring, with 2 or 4 chains and spikes

Coupling mm / Inch	 mm	 mm	Working range mm	 g	No.
Without ring, with 2 chains					
16 / 5/8"	30	155	50 - 125	160	72186
22 / 7/8"	50	170	100 - 150	860	72278
Without ring, with 4 chains					
16 / 5/8"	40	155	75 - 125	280	72188
22 / 7/8"	60	170	100 - 150	880	72299
32 / 1.1/4"	80	220	100 - 200	1,460	72348



No. 72188

Flushing and pipe cleaning

Drain cleaning tools

Carbide-tipped cutters

- Carbide-tipped cutters for the hardest obstructions and incrustations such as cement deposits, urine and water scale and other hard deposits
- Recommended for use with S- or SMK-spirals

Carbide-tipped cutters!



Coupling mm / Inch	mm	Form	Working range mm	g	No.
16 / 5/8"	30	straight	50 - 75	80	72193
22 / 7/8"	45	pointed	60 - 100	320	72295
32 / 1.1/4"	80	straight	100 - 200	530	72398

Serrated forked cutter

- Particularly suitable for sludge deposits and roots
- Hardened spring steel cutter with teeth on both sides, long service life



Coupling mm / Inch	mm	L mm	Working range mm	g	No.
22 / 7/8"	76	100	100 - 150	230	72250
22 / 7/8"	100	100	125 - 150		72251
32 / 1.1/4"	76	100	120 - 200	260	72350
32 / 1.1/4"	100	100	125 - 200		72351

Two-way root cutter

- With hardened spring steel cutter for chopping up roots in both directions
- Recommended for use with S- or SMK-spirals
- Not suitable for use with plastic pipes

Replaceable blades!



Coupling mm / Inch	mm	L mm	Working range mm	g	No.
22 / 7/8"	65	80	100 - 125	250	72265
22 / 7/8"	90	85	125 - 200	290	72266
32 / 1.1/4"	65	80	100 - 125	290	72365
32 / 1.1/4"	90	90	125 - 200	330	72366

Ball head cutter

- Perfectly suited for use in pipes with hard incrustations such as lime, urine scale etc.
- Suitable for downpipes, its round shape ensures excellent curve mobility even at 90°



Coupling mm / Inch	Working range mm	mm	g	No.
4 Blades				
16 / 5/8"	50 - 75	25	42	72168
16 / 5/8"	50 - 75	35	80	72172
22 / 7/8"	100 - 125	55	198	72223
22 / 7/8"	100 - 150	75	438	72224
22 / 7/8"	100 - 150	95	634	72226
32 / 1.1/4"	100 - 125	55	228	72324
32 / 1.1/4"	100 - 150	75	468	72326
8 Blades				
22 / 7/8"	125 - 150	90	1,025	72227
22 / 7/8"	125 - 150	115	1,225	72228
32 / 1.1/4"	125 - 200	95	1,108	72327
32 / 1.1/4"	150 - 200	115	1,256	72328

Flushing and pipe cleaning

Drain cleaning tools

Tool set L

Ø 16 mm, 10 pieces



Set (No. 72936) includes: ROCASE (No. 1300003334) with inlay (No. 1300003372), separating key 16 mm (No. 72100), retrieving auger 16 mm (No. 72162), bulb auger 16 mm (No. 72163), serrated forked cutter 16 mm (No. 72164), blade cutter 16/25 mm (No. 72169), cross-blade cutter 16/45 mm (No. 72177), chain-spinning head 16 mm with 2 smooth chains (No. 72185), guide gloves, left/right (No. 150000439), ROWONAL spiral spray (No. 72142)

Model	No.
16 mm tool set L (R 550, R 600, R 650)	72936

Tool set S

Ø 16 mm, 5 pieces



Set (No. 72937) includes: separating pin 16 mm (No. 72100), straight auger 16 mm (No. 72161), bulb auger 16 mm (No. 72163), blade cutter 16 mm (No. 72169), cross-blade cutter 16 mm (No. 72175)

Model	No.
16 mm tool set S (R 550, R 600, R 650)	72937

Tool set L

Ø 22 mm, 11 pieces

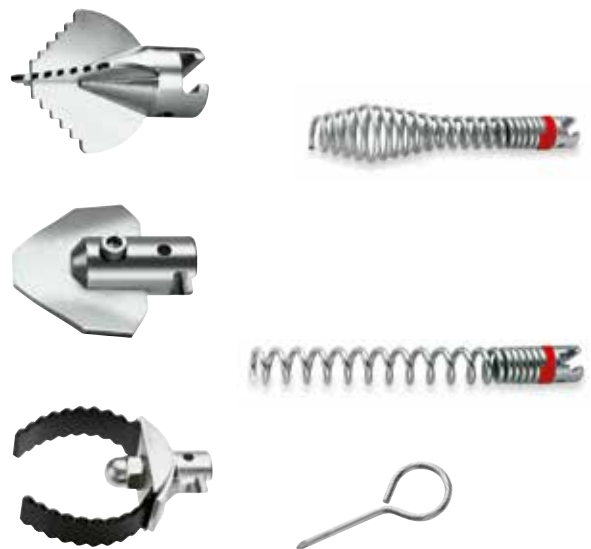


Set (No. 72938) includes: ROCASE (No. 1300003334) with inlay (No. 1300003372), separating key 22 mm (No. 72101), retrieving auger 16 mm (No. 72203), serrated forked cutter 22 mm (No. 72250), spade head cutter 22/65 mm (No. 72261), bulb auger 22 mm (No. 72263), two-way root cutter 22/65 mm (No. 72265), cross-blade cutter 22/65 mm (No. 72276), chain-spinning head 22 mm with 2 smooth chains (No. 72284), guide gloves, left/right (No. 150000439), ROWONAL spiral spray (No. 72142)

Model	No.
22 mm tool set L (R 600, R 650, R 750)	72938

Tool set S

Ø 22 mm, 6 pieces



Set (No. 72939) includes: separating pin 22 mm (No. 72101), straight auger 22 mm (No. 72221), serrated forked cutter 22 mm (No. 72250), spade head cutter 22 mm (No. 72261), bulb auger 22 mm (No. 72263), cross-blade cutter 22 mm (No. 72276)

Model	No.
22 mm tool set S (R 600, R 650, R 750)	72939

Flushing and pipe cleaning

Drain cleaning tools

With Locking



Spiral and tool sets

Standard Ø 16 mm



Set (No. 072945X) includes: spiral basket 16 mm (No. 72110), 5 x 16 mm standard spirals (No. 72431), straight auger 16 mm (No. 72161), bulb auger 16 mm (No. 72163), blade cutter 16/25 mm (No. 72169), separating pin 16 mm (No. 72100), guide gloves, left/right (No. 1500000439), ROWONAL spiral spray (No. 72142), ROCASE (No. 1300003334) with inlay (No. 1300003372)

Model	Description	kg	No.
Standard 16 mm	with standard spirals	12.0	072945X

Spiral and tool sets

Standard Ø 16 / 22 mm



Set (No. 072956X) includes: spiral basket 16 mm (No. 72110), 5 x 16 mm standard spirals (No. 72431), straight auger 16 mm (No. 72161), bulb auger 16 mm (No. 72163), blade cutter 16/25 mm (No. 72169), separating pin 16 mm (No. 72100), spiral basket 22 mm (No. 72112), 5 x 22 mm standard spiral (No. 72441), straight auger 22 mm (No. 72221), bulb auger 22 mm (No. 72263), funnel auger 22 mm (No. 72222), spade head cutter 22/65 mm (No. 72261), serrated forked cutter 22/76 mm (No. 72250), separating pin 22/32 mm (No. 72101), guide gloves, left/right (No. 1500000439), ROWONAL spiral spray (No. 72142), ROCASE (No. 1300003334) with inlay (No. 1300003372)

Model	Description	kg	No.
Standard 16 - 22 mm	with standard spirals	38.0	072956X
SMK 16 - 22 mm	with SMK-spirals	39.0	072967X

Spiral and tool sets

Standard Ø 22 mm



Set (No. 072955X) includes: spiral basket 22 mm (No. 72112), 5 x 22 mm standard spirals (No. 72441), straight auger 22 mm (No. 72221), bulb auger 22 mm (No. 72263), funnel auger 22 mm (No. 72222), spade head cutter 22/65 mm (No. 72261), serrated forked cutter 22/76 mm (No. 72250), separating pin 22/32 mm (No. 72101), guide gloves, left/right (No. 1500000439), ROWONAL spiral spray (No. 72142), ROCASE (No. 1300003334) with inlay (No. 1300003372)

Model	Description	kg	No.
Standard 22 mm	with standard spirals	24.0	072955X

Spiral and tool sets

Standard Ø 32 mm



Set (No. 072962X) includes: spiral basket 32 mm (No. 72111), 5 x 32 mm standard spirals (No. 72451), straight auger 32 mm (No. 72321), retrieving auger 32 mm (No. 72325), funnel auger 32 mm (No. 72322), spade head cutter 32/65 mm (No. 72360), spiral sawtooth cutter 32/65 mm (No. 72329), separating pin 22/32 mm (No. 72101), guide gloves, left/right (No. 1500000439), ROWONAL spiral spray (No. 72142), ROCASE (No. 1300003334) with inlay (No. 1300003372)

Model	Description	kg	No.
Standard 32 mm	with standard spirals	37.0	072962X

11

DuraFlex spiral and tool set

Standard Ø 16 / 22 mm

**RO
CASE**



Set (No. 1500003705) includes: spiral basket 16 mm (No. 72110), 5 x 16 mm DuraFlex spirals (No. 1500003703), straight auger 16 mm (No. 72161), bulb auger 16 mm (No. 72163), blade cutter 16/25 mm (No. 72169), separating pin 16 mm (No. 72100), spiral basket 22 mm (No. 72112), 5 x 22 mm DuraFlex spirals (No. 15000003704), ROCASE (No. 1300003334) with inlay (No. 1300003372), straight auger 22 mm (No. 72221), bulb auger 22 mm (No. 72263), funnel auger 22 mm (No. 72222), spade head cutter 22/65 mm (No. 72261), serrated forked cutter 22/76 mm (No. 72250), separating pin 22/32 mm (No. 72101), guide gloves, left/right (No. 1500000439), ROWONAL spiral spray (No. 72142)

Model	kg	No.
DuraFlex SMK spiral and tool set, 16/22 mm	34.0	1500003705

Spirals 8 mm / 10 mm

For ROSPI H+E PLUS, ROSPI R 36 PLUS, ROSPIMATIC and adaptor magazine

KEY FEATURES

- Heavy duty spiral made out of special steel (DIN EN 10270-1) with integrated bulb auger (except No. 72421, 72423)
- Suitable for ROSPI H+E Plus, ROSPI 36 Plus, ROSPIMATIC as well as with adaptor R 600, R 650

- The wire diameter with an 8 mm spiral averages Ø 2 mm, and with 10 mm spirals Ø 2.5 mm
- Easy to use, even in tight bends, especially with 8 mm spirals also directly through sink strainers, crosses and drains without having to disassemble the drain or stench tap

mm	Wire Ø	m	Type	Steel core	Use for ROSPI	kg	No.
6.4	2 mm	4.5	-	-	R 6	0.8	72522
8	2 mm	7.5	C 1	-	R 8 - R 36	1.8	72412
8	2 mm	7.5	C 1 - IC	●	R 8 - R 36	2.3	72413
8	2 mm	10.0	-	-	R 8 - R 36	2.4	72414
8	2 mm	10.0	-	●	R 10 - R 36	3.0	72415
10	2.5 mm	10.0	C 5	-	R 10 - R 36	3.5	72422
10	2.5 mm	7.5	C 4	-	R 10 - R 36	2.9	72420
10	2.5 mm	7.5	C 4 - IC	●	R 10 - R 36	72424	
10	2.5 mm	7.5	-	-	R 10 - R 36	72421*	
10	2.5 mm	7.5	-	●	R 10 - R 36	2.9	72423*

*with T-groove coupling



No. 72412



No. 72421 / No. 72423

Reducing / extension pieces

For spirals with T-coupling

Within limits, tools with larger or smaller lead-ins can also be adapted



No. 72461



No. 72460

Model	negative	positive	g	No.
Extension piece	16 mm	22 mm	140	72461
Reducing piece	22 mm	16 mm	150	72460
Extension piece	22 mm	32 mm	320	72463

Safety T-couplings

Model	g	16 mm 5/8"	g	22 mm 7/8"
for Standard and SMK-spirals				
positive	20	72150	40	72210
negative	20	72151	40	72211

for Standard and SMK-spirals



No. 72210

No. 72211

Fixing of broken spirals!

Flushing and pipe cleaning

High-pressure drain cleaning

High-pressure drain cleaning



Operation mode:	230 V	400 V
Max. pipe diameter:	Ø 150 mm	Ø 200 mm
Max. working length:	20 m	40 m
Max. pressure:	100 bar	190 bar
Pump delivery:	13 l/min	17 l/min
Power:	2,300 W	5,000 W

HD 13/100

100 bar high-pressure pipe cleaning unit with hose reel

Ø 150 mm



HD 17/190

190 bar high-pressure pipe cleaning unit with three-phase motor

Ø 200 mm



11

KEY FEATURES

- Air-filled transport wheels, easy to navigate stairs
- AC supplied, self-priming up to 2 m

TECHNICAL DATA

Max. operating pressure:	100 bar
Electric motor:	AC supply
Pump delivery:	13 l/min
Rating:	2.3 kW
Max. working length:	20 m
Speed:	1,400 rpm

Scope of delivery: HD 13 / 100 (No. 76020), hose reel with 20 m special high-pressure hose (No. 72812) with couplings and pipe cleaning nozzle (No. 76089)

Model	230 V / 50 Hz
High-pressure pipe cleaning unit HD 13/100	45.0 76020

KEY FEATURES

- Three-phase motor, self-priming up to 2 m
- Air-filled transport wheels, easy to navigate stairs

TECHNICAL DATA

Max. operating pressure:	190 bar	Electric motor:	Three phase
Pump delivery:	17 l/min	Rating:	5.0 kW
Max. working length:	40 m	Speed:	2,800 rpm

Scope of delivery: HD 17 / 190 (No. 76070), hose reel with 40 m special high-pressure hose DN 8 with couplings (No. 72820) and pipe cleaning nozzle (No. 76089)

Model	400 V / 50 Hz
High-pressure pipe cleaning unit HD 17 / 190	50.0 76070

Flushing and pipe cleaning

High-pressure drain cleaning

ACCESSORIES HD 13/100 – 17/190 – 19/180

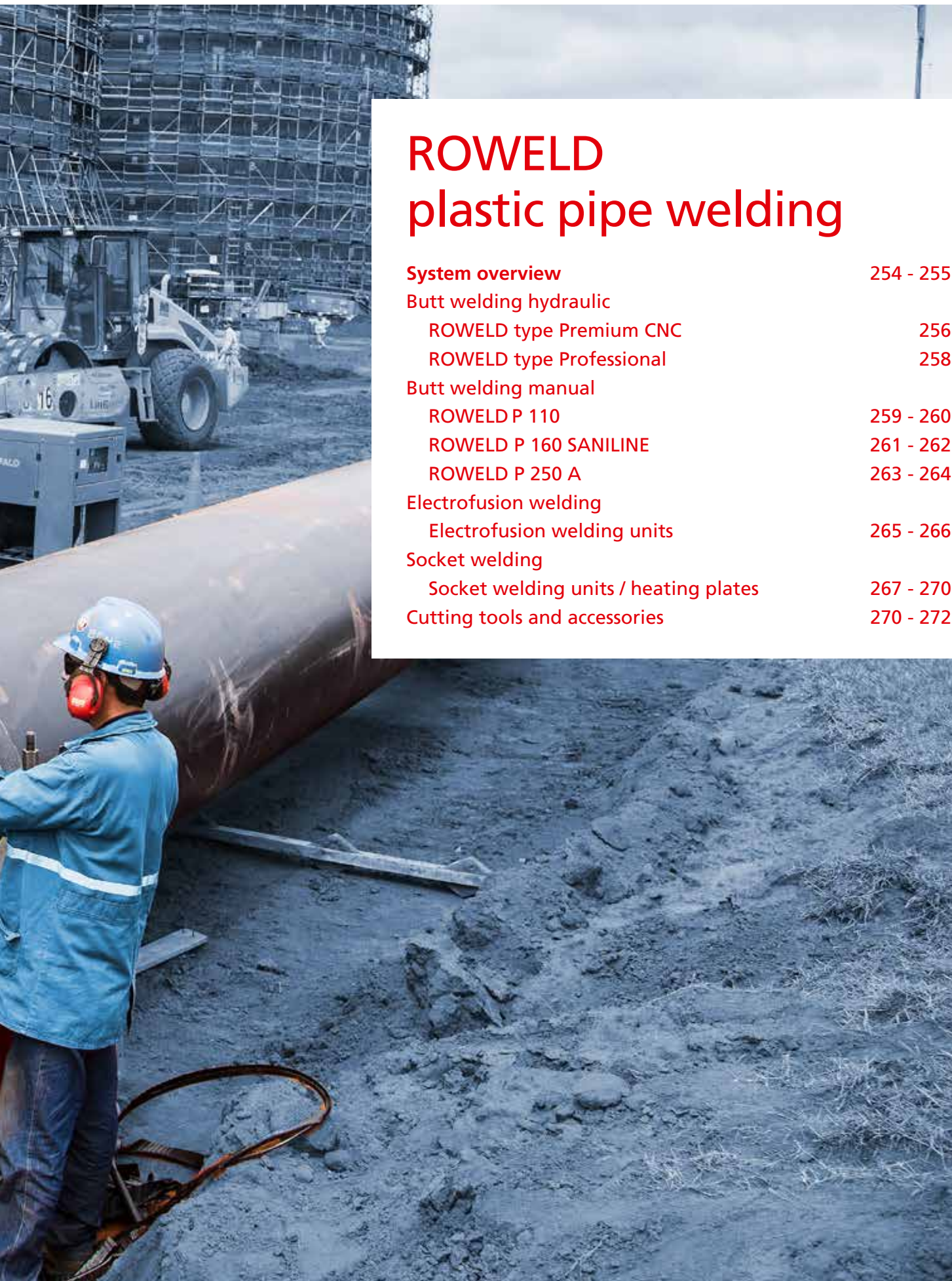


No. 76067

11

Model	kg	No.
Flexible, high-pressure hose with R 1/4" coupling		
Length 40 m, NW 8 (HD 17/190, HD 19/180 B)	10.70	72820
Pipe cleaning nozzles R1/4", stainless steel	0.04	76089
excl. forward jet spray, 4 holes, Ø 25 x 22 mm		
incl. forward jet spray, 5 holes, Ø 25 x 22 mm	0.04	76065
Rotary nozzle 45°, 4 holes, Ø 16 x 30 mm	0.08	77506
Cleaning lance with wide-angle nozzle	1.30	76068
for surface cleaning		
Spare wide-angle nozzle	0.01	76088





ROWELD plastic pipe welding

System overview	254 - 255
Butt welding hydraulic	
ROWELD type Premium CNC	256
ROWELD type Professional	258
Butt welding manual	
ROWELD P 110	259 - 260
ROWELD P 160 SANILINE	261 - 262
ROWELD P 250 A	263 - 264
Electrofusion welding	
Electrofusion welding units	265 - 266
Socket welding	
Socket welding units / heating plates	267 - 270
Cutting tools and accessories	270 - 272

Plastic pipe welding

System overview

Butt welding hydraulic

ROWELD type Premium CNC



ROWELD type Professional



(Fig. similar)

Suited for:	PE, PP, PVDF	PE, PP, PVDF
Outer pipe diameter:	Ø 90 - 630 mm	Ø 40 - 1200 mm
Operation mode:	Automatic CNC controlled	Manual
Voltage:	230 V, 50/60 Hz	230 V, 50/60 Hz
Documentation:	✓	–
Page	256	258

Butt welding manual

ROWELD P 110



ROWELD P 160



ROWELD P 250 A



Suited for:	PE, PP, PVDF	PE, PP, PVDF	PE, PP, PVDF
Outer pipe diameter:	Ø 20 - 110 mm	Ø 40 - 160 mm	Ø 40 - 250 mm
Wall thickness:	see technical data	see technical data	see technical data
Operation mode:	Manual	Manual	Manual
Page	259	261	263

Electrofusion welding

ROFUSE 1200 TURBO



ROFUSE 400 TURBO



ROFUSE Sani 160 / 315



Suited for:	PE, PP	PE, PP	PE
Outer pipe diameter:	Up to Ø 1200 mm ¹⁾	Up to Ø 400 mm	Up to Ø 160 / 315 mm
Fitting type:	Fittings for pressure pipe systems	Fittings for pressure pipe systems	Fittings for drainage pipe systems
Voltage:	8 - 48 V	8 - 48 V	230 V
Documentation:	✓	✓	–
Page	265	265	266

Socket welding

ROWELD P 63 S-6



ROWELD P 125



Suited for:	PE, PP	PE, PP
Outer pipe diameter:	Ø 32 - 63 mm	Ø 16 - 125 mm
Wall thickness:	see technical data	see technical data
Operation mode:	Electric	Electric
Function:	Socket welding	Butt welding, socket welding
Page	267	269

Socket welding

Heating element HE 120



Heating element HE 200



Heating element HE 300



Suited for:	PE, PP, PVDF	PE, PP, PVDF	PE, PP, PVDF
Outer pipe diameter:	Up to Ø 120 mm	Up to Ø 200 mm	Up to Ø 300 mm
Wall thickness:	see technical data	see technical data	see technical data
Operation mode:	–	–	–
Page	269	269	269

Cutting

ROCUT XL 125



ROCUT XL 225



ROCUT XL 315



ROCUT UKS 160 / 355



Suited for:	PE	PE	PE	PE, PP, PVC
Outer pipe diameter:	Up to Ø 125 mm	Up to Ø 225 mm	Up to Ø 315 mm	Ø 160 - 355 mm
Wall thickness:	Up to max. 11,4 mm	Up to max. 18 mm	Up to max. 18 mm	Up to max. 40 mm
Operation mode:	Manual	Manual	Manual	Electrical
Function:	Cutting	Cutting	Cutting	Cutting
Page	271	271	271	271

Plastic pipe welding

Butt welding

ROWELD type Premium CNC

Hydraulic butt-welding machine Ø 90 - 1200 mm

The Premium CNC System enables a nearly fully automated operation. All parameters are documented automatically.

Product profile

APPLICATION AREA

The ROWELD Hydraulic Premium CNC with integrated CNC control and touch screen panel for the quick and reliable saving of the welding parameters in accordance with DVS and other applicable international guidelines and standards. Data transfer via USB interface.

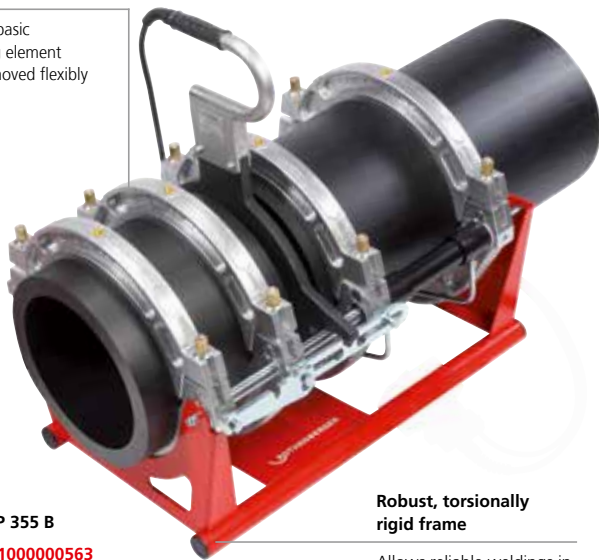
WORKING RANGE

Model	Ø mm
P 250 B SA	90 - 250 mm
P 250 B VA	90 - 250 mm
P 355 B SA	90 - 355 mm
P 355 B VA	90 - 355 mm
P 500 B SA	200 - 500 mm
P 630 B SA	315 - 630 mm

SA = semi-automatic, VA = fully automatic

Flexible

The 3rd basic clamping element can be moved flexibly



Set P 355 B
No. 100000563

Robust, torsionally rigid frame

Allows reliable weldings in virtually any environment

TECHNICAL DATA

- Automatic logging:** 10,000 logs
- Data output:** USB interface
- Languages:** DE, EN, FR, ES, NL, PT, DK, SE, NO, FI, PL, TR, HU, SL, SK, RU, BG, further languages available upon request
- Welding monitoring:** Optically with colour indication for welding pressure, welding temperature, welding times, as well as acoustical and optical for user actions
- Logging:** in accordance to DVS
- Welding standards:** DVS, further standards available upon request, manual entry of welding parameters is possible
- With CNC function:** During the welding process, all movements are performed by the machine, including dragging resistance and bead development measurement. Automatic extending heading element enables a fully-automatic welding process (optional, not available for all machines)

Simple operation

Ideally matched components allow precise start-up of the pressure



Safe

Perfect parking for trimmer and heating plate



Simple operation via touch control panel



Trimmer with safety switch. Secures against unintended activation of the trimmer



Safe operation – Automatic calculation, control and inspection of the welding parameters





The pull-off fixture allows rapid lifting out of the heating element



The new generation of ROWELD hydraulic controls for butt welding

The ROWELD hydraulic unit is available in a **Professional** and **Premium CNC** version.

Everything at a glance...	 Fig. similar Type Professional	 Type Premium CNC
Temperature control	•	•
Pressure reading analogue	•	—
Pressure reading digital	—	•
Pressure hold function	•	•
Logging system	—	•
Position sensor	—	•
Automatic parameter calculation	—	•
CNC-control	—	•
Touch screen	—	•
Colour display 3.5"	—	•
Menu language	—	•
Multi-lingual	—	•
USB port	—	•



Plastic pipe welding

Butt welding

ROWELD type Professional

Hydraulic butt welding machine Ø 40 - 1200 mm

Selection of components with a long service life ensures a low maintenance, robust and reliable operating mode.

Product profile

APPLICATION AREA

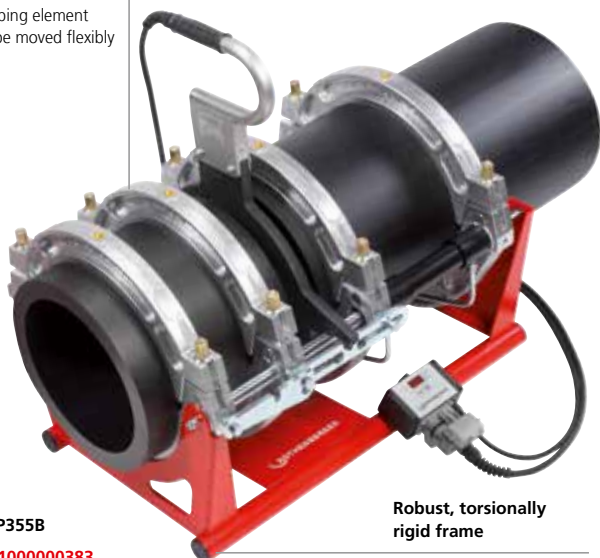
Butt welding of PE, PP and PVDF pipes and moulded bodies. For use on the building site, in pipe trenches, on pipe bridges and in workshops. The ROWELD hydraulic type Professional with infinite pressure adjustment, an easily legible manometer and pressure reservoir for welding according to DVS and other internationally valid guidelines and standards.

WORKING RANGE

Model	Ø mm
P 160 B	40 - 160 mm
P 200 B	63 - 200 mm
P 250 B	90 - 250 mm
P 355 B	90 - 355 mm
P 500 B	200 - 500 mm
P 630 B	315 - 630 mm
P 800 B	500 - 800 mm
P 1200 B	710 - 1200 mm

Flexible

The 3rd basic clamping element can be moved flexibly



Set P355B

No. 100000383

Robust, torsionally rigid frame

Allows reliable weldings in virtually any environment

Simple operation

Ideally matched components allow precise start-up of the pressure



Safe

Perfect parking for trimmer and heating plate



Fig. similar

12

Supply of power for heating element and trimmer unit over Professional Hydraulic (P 160 B-P 355 B)



Electronic control for heating element can be placed flexibly using a magnet (P 355 B)



Professional Hydraulic with large, easily legible manometer as well as a pressure limiting and pressure relieving valve



The pull-off fixture allows rapid lifting out of the heating element



Plastic pipe welding

Butt welding

ROWELD P 110

Plastic pipe welding machine Ø 20 - 110 mm



Product profile

APPLICATION AREA

For butt welding of pipes and fittings made of PE, PP, PB and PVDF. Particularly suited for installation work and for work in confined spaces - also in pipe networks

KEY FEATURES

- Production of segmented bends possible
- Precise pressure adjustment
- Single and double-sided trimming possible

KEY FEATURES

- Production of pipe and fitting joints
- Secure hold and simple axial pipe alignment

TECHNICAL DATA

Pipe diameter: Ø 20 - 90 mm (SDR 41 - SDR 7.25)
 Ø 20 - 110 mm (SDR 41 - SDR 11)

Weight: 8.5 kg

Size: 450 mm total length

Narrow basic clamping elements can be used

Segmented bends can be produced

Mechanical stop adjustable from both sides

Single and double-sided trimming possible

Hardened, chrome-plated guide shafts

Absolutely warp-resistant

Wide aluminium reducer clamp inserts (Ø 20 - 90 mm) for pipes and pipe joints

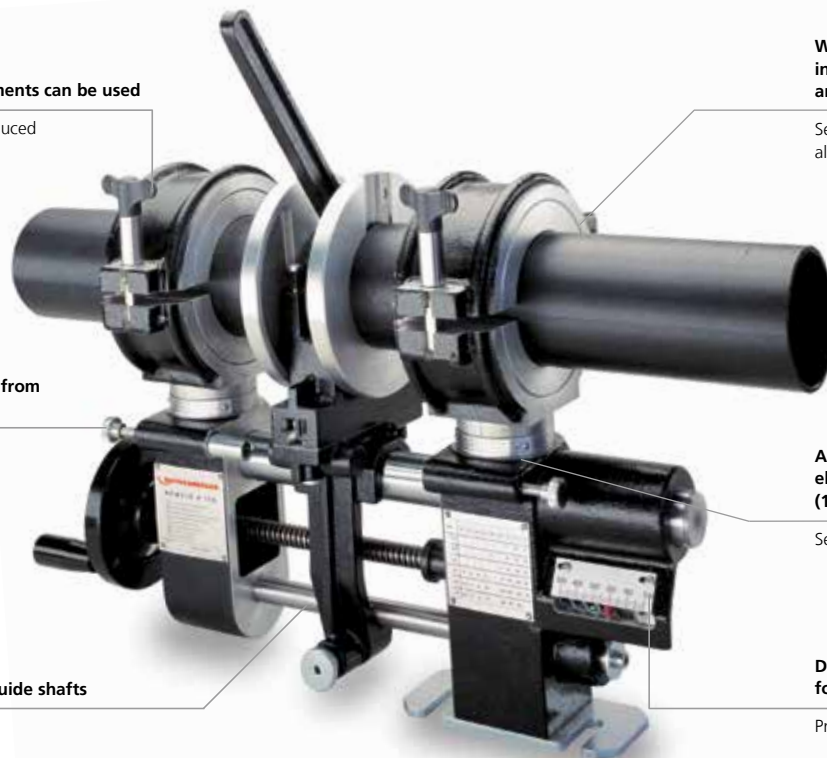
Secure hold and simple axial pipe alignment

Angles of the wide basic clamping elements adjustable on both sides (15° each)

Segmented bends can be produced

Direct force transmission and clear force scale

Precise pressure adjustment



Rectangular heating element



Joints between fittings and pipes with narrow and wide clamping elements



By adjusting the basic clamping element angles on both sides (15° each side) segmented bends can be produced



Set (No. 55844) includes: Basic machine (No. 55787) with table mounting brackets, manual trimmer unit (No. 55826), electronically controlled heating plates, basic clamping set R/R (No. 55807) (Ø 110 mm) and basic clamping set R/F, left (No. 55808) (Ø 110 mm), reducer clamping inserts R/R and R/F for Ø 40 - 90 mm, assembly tools, table mounting clamp (No. 55524), transport box (No. 55832)



Model	Working range Ø mm	Temperature control	kg	230 V 50/60 Hz	110/115 V 50/60 Hz
ROWELD P 110 complete	40, 50, 56, 63, 75, 90, 110	electronically	43	55844	55924

Plastic pipe welding

Butt welding

ROWELD P 110 basic machine

Model	kg	No.
ROWELD P 110 basic machine with table mounting bracket	6.8	55787



Basic clamping set 110 mm

Model	kg	No.
For wide/pipe joints (1 set = 2 clamps)	2.5	55807
For narrow/fitting joints, left (1 clamp)	1.0	55808
For narrow/fitting joints, right (1 clamp)	1.0	55809



Reduction inserts wide P 110

Each set includes 4 aluminium half-shells

mm	kg	No.	mm	kg	No.
20	1.9	55318	56	1.6	55122
25	1.9	55126	63	1.4	55121
32	1.8	55125	75	1.6	55120
40	1.7	55124	90	1.1	55119



Reduction inserts narrow P 110

Each set includes 4 metal half-shells

mm	kg	No.	mm	kg	No.
20	0.6	55319	56	0.5	55130
25	0.6	55134	63	0.5	55129
32	0.5	55133	75	0.4	55128
40	0.5	55132	90	0.3	55127



Manual trimmer unit

Model	kg	No.
With machine holder	1.90	55826
Spare blade (1 set = 2 blades)	0.05	55152



Heating plate

With non-stick Teflon coating, 180 x 130 mm, 800 W

Model	kg	230 V 50/60 Hz	110/115 V 50/60 Hz
Electronically controlled	2.6	55324	55918
Table clamp	0.7	55524	55524



Flange adaptor clamping unit

For centred welding of flanges

Model	kg	No.
Flange adaptor clamping unit	1.50	55199
Steel carrying case (540 x 345 x 355 mm)	14.20	55832
Hex key SW 6	0.03	321216
Hex key SW 8	0.05	321218



Plastic pipe welding

Butt welding

ROWELD P 160 SANILINE

Plastic sanitary pipe welding machine from Ø 40 - 160 mm



Product profile

APPLICATION AREA

For butt welding of PP, PB and PVDF pipes and fittings, especially suitable for 45° branches and tight elbows. For use on building sites or in the workshop

KEY FEATURES

- Versatile for difficult situations with the removable heating plates
- Secure clamping of pipes, fittings, tight 45° branches and 90° elbows
- Protects against unintentional starting and derailing of the trimmer unit
- Precise pressure adjustment

KEY FEATURES

- Minimum drag force
- 40% higher stability with simultaneously optimised force distribution
- All common sanitary installation fittings can be clamped

TECHNICAL DATA

Pipe diameter:	Ø 40 - 110 mm (SDR 41 - 7.25)
	Ø 40 - 140 mm (SDR 41 - 11)
	Ø 40 - 160 mm (SDR 41 - 17)
Weight:	34.4 kg
Heating plate:	800 W
Trimmer unit:	1050 W

Multi-faceted options for clamping

All commonly used moulded bodies installed in a sanitary installation can be clamped

Anti-slip Ø 40 - 140 mm reduction clamping inserts with clamping force regulation

Secure mounting of pipes, moulded bodies, tight 45° forks and 90° bends

ROCASE 4414

Additional storage for accessories and tools



The pressure applied can be adjusted separately on both sides

One-sided and two-sided milling is possible

Direct force transmission and a clearly arranged force scale

Precise force adjustment

P 160 SANILINE complete (No. 100002964)



Trimmer attachment (No. 54040) (special accessories)



Basic clamping set (No. 54082) (special accessories)



Set (No. 100002964) includes: Basic unit with electric trimmer, electrically adjustable heating element, removable. Pipe support Ø 160 mm, reducer clamp and support set for Ø 40, 50, 63, 75, 90, 110 and 125 mm in ROCASE 4414 (No. 100002970), installation tools, mobile work and transport frame (No. 100002971)

Model	Working range Ø mm	Temperature control	kg	230 V 50 Hz
ROWELD P 160 SANILINE	40, 50, 63, 75, 90, 110, 125, 160	electronically	57.4	100002964
ROWELD P 160 SANILINE	40, 50, 63, 75, 90, 110, 125, 160 incl. 56 mm insert	electronically	57.5	100002967

Plastic pipe welding

Butt welding

ROWELD P 160 SANILINE basic machine

Basic machine includes: Trimmer unit (1050 W), heating plate (800 W), basic clamp set Ø 40 - 160 mm

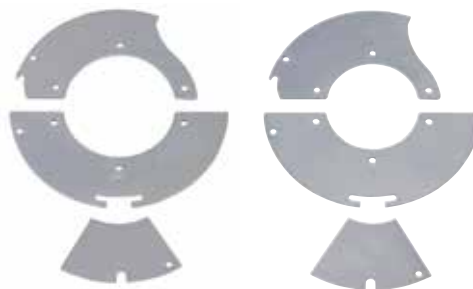


Model		230 V 50 Hz
ROWELD P 160 SANILINE Basic machine	34.4	54005

Reduction inserts P 160 SANILINE

Set includes: Reducer inserts (4 half-shells), pipe supports

Nominal size		No.	Nominal size		No.
40	1.6	54083	90	1.6	54088
50	1.6	54084	110	1.7	54089
56	1.6	54085	125	1.5	54090
63	1.6	54086	140	1.5	54091
75	1.6	54087			



Trimmer adaptor P 160 SANILINE

(special accessories)

Ø 40 - 75 mm for trimming 45° branches, replaceable blades

Model		No.
Trimmer attachment for Ø 40 - 75 mm	0.63	54040



Basic clamping set P 160 SANILINE

(special accessories)

For outer clamping position, especially for welding pressure pipes, includes 2 basic clamps, left and right, up to Ø 160 mm

Model		No.
Basic clamping set Ø 160 mm	5.3	54082



ROWELD P 160 SANILINE Conversion Kit

Converting existing ROWELD P 160 SANILINE with universal clamp system

Set (No. 54080) includes: Basic clamping set Ø 160 mm left and right, (No. 54082) as well as two reducer clamping sets (left and right) for the diameters 40, 50, 63, 75, 90, 110 and 125 mm

Model	Working range Ø mm		No.
Conversion Kit	40, 50, 63, 75, 90 110, 125, 160	11.20	54080
Trolley and transport sub-frame		11.30	1000002971
Folding trolley		20.00	56051
ROCASE for reducers		1.70	1000002970
Open-ended spanner SW 17 DIN 894		0.05	310411
Trimmer unit blades 75 mm (set = 2 blades)		0.10	55685
Blades 35 mm for trimmer adaptor		0.01	55686
Heating plate 230 V / 115 V / 110 V		1.92	55316 / 55851
Trimmer blade, carbide 75 mm (set = 2 blades)		0.05	55684



No. 54080



Plastic pipe welding

Butt welding



ROWELD P 250 A

Plastic pipe welding machine Ø 40 - 250 mm

Product profile

APPLICATION AREA

For use on building sites and in the workshop. Particularly suited for sanitary installations, drain pipe laying as well as chimney reconditioning with PVDF liners

KEY FEATURES

- Versatile for difficult situations with the removable heating plates
- Protects against unintentional starting and derailing of the trimmer unit
- Single and double-sided trimming possible
- Warp-resistant for minimum drag and low pressure transfer loss

KEY FEATURES

- Precise welding pressure adjustments on the clear force scale
- Reliable, warp-resistant transfer of the welding pressure
- Stable working table always available

TECHNICAL DATA

Pipe diameter:	Ø 40 - 110 mm (SDR 41 - SDR 7.25)
	Ø 40 - 125 mm (SDR 41 - SDR 11)
	Ø 40 - 200 mm (SDR 41 - SDR 17)
	Ø 40 - 225 mm (SDR 41 - SDR 26)
	Ø 40 - 250 mm (SDR 41 - SDR 33)
Weight:	36.4 kg
Trimmer unit:	450 W
Heating plate:	1200 W

Electric, high-torque safety trimmer unit (450 W) locks into place in the working position

Protects against unintentional starting and derailing of the trimmer unit

Mechanical stop adjustable from both sides

Single and double-sided trimming possible

Removable heating plate

Versatile for difficult situations

Rugged basic clamping set Ø 250 mm with reducer inserts for Ø 180 - 225 mm plus pipe supports and Ø 160 mm set with reducer inserts for Ø 40 - 140 mm plus pipe supports

Reliable, warp-resistant transfer of the welding pressure



Mounted machine carriage is smooth running, hardened, chrome-plated ball lining driven in guide shaft

Warp-resistant, for minimum drag force and low loss of pressure transfer

12

Model	Working range Ø mm	Temperature control	kg	230 V 50 Hz
ROWELD P 250 A Set	40, 50, 56, 63, 75, 90, 110, 125, 160, 180, 200, 225, 250	electronically	131.0	55795
ROWELD P 250 A basic machine			36.1	55768

Plastic pipe welding

Butt welding

ROWELD P 250 A set Basic machine with trimmer unit

Set (No. 55795) includes: holder for heating plate, electronically adjustable heating plate, basic clamping set Ø 160 mm and 250 mm support fork inserts Ø 160 mm and 250 mm, reducer inserts and support fork inserts from Ø 40 - 140 mm and Ø 180 - 225 mm, installation tools, steel transport box 800 x 520 x 765 mm (LxWxH) and steel carrying case for reducer and support fork inserts



Basic clamping set P 250 A

Set includes: 2 basic clamps and 2 support forks

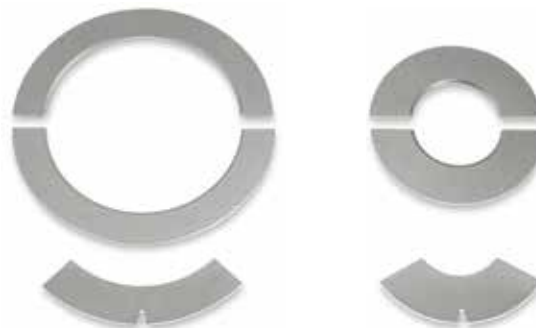
mm	kg	No.	mm	kg	No.
160	7.25	55742	250	10.10	55717



Reduction inserts P 250 A

Each set consists of: Pipe clamping inserts (4 metal half-shells) and support fork inserts (2 metal half-shells) for basic clamping set (No. 55742)

mm	kg	No.	mm	kg	No.
32	1.89	55753	110	1.26	55746
40	1.89	55752	114	1.20	55745
50	1.81	55751	125	1.06	55744
56	1.83	55750	140	0.80	55743
63	1.75	55749	180	2.46	55721
75	1.68	55748	200	2.03	55718
90	1.50	55747	225	1.41	55719



12

Heating plate

Non-stick Teflon coating. Ø 300 mm, 1,500 W

Model	kg	230 V 50 / 60 Hz	110 V / 115 V 50 / 60 Hz
Electronically controlled	5.35	55317	55854

Spare parts

Model	kg	230 V 50 / 60 Hz	110 V / 115 V 50 / 60 Hz
Spare blade (1 set = 2 pcs.)	0.10		55163
Hex key size 8	0.20	321218	321218
Transport box, protective cover red	25.00	55759	55759
Steel carrying case	2.82	54020	54020



No. 55317 / No. 55854

Plastic pipe welding

Electrofusion welding



ROFUSE 400 / 1200 TURBO

Universal electrofusion welding units for PE- and PP-pressure fittings up to 400 and up to 1200 mm diameter

Product profile

KEY FEATURES

- **Safety:** The **Heat-Control (HC)** function evaluates based on ambient temperature, device temperature and fitting and checks if the next fitting can be welded completely. This process is fully automated and indicated through a green or a red light shown on the display. This prevents any emergency shut-off of the unit due to overheating.
- **Performance:** Due to the **Active-Cooling (AC)** function, the unit is ideally fitted for continuous use since the heat removal is maximised by the installed ventilator.
- **Complete solution:** All cables are securely stowed away inside the robust housing. The housing also offers sufficient space for accessories, tools or fittings.
- **Professional documentation:** All saved welding sequences can be transferred to a computer with a USB drive. From the computer the data can be archived and printed using the read out programme "RODATA 2.0".
- **Barcode generator:** "RODATA 2.0" offers also the possibility to encrypt the name of the welder and the name of the construction site as a barcode. This barcode can then be scanned at the job site.

TECHNICAL DATA:

Mains voltage:	230 V
Frequency:	50/60 Hz
Power:	3,000 VA, 70 % ED
Output current (nominal output):	80 A
Welding voltage:	8 - 48 V
Ambient temperature:	-10 °C up to 60 °C
Working range	
ROFUSE 400 TURBO:	Fittings up to 400 mm
ROFUSE 1200 TURBO:	Fittings up to 1200 mm
Protection class:	IP 54
Transmission interface:	USB v. 2.0
Storage capacity:	2000 welding logs
Weight incl. welding cable:	approx. 21.5 kg
(Basic unit without accessories)	

Language neutral instruction manual

Easy to operate

Practical pocket

for the welder's name and scan site-code

USB

Simple data transmission

Height-adjustable cover

Can be used as a sun shield

Clear display

Allows intuitive operation. The program sequence can be adapted individually

Robust housing

The cable can be stowed away securely

Wireless scanner

Simple and unlimited handling



Model	kg	No.
ROFUSE 400 TURBO	21.5	100000999

Model	kg	No.
ROFUSE 1200 TURBO	21.5	100001000

¹⁾ Complete terms and conditions at rothenberger.com/roservice
RO SERVICE+ only valid in participating countries

Plastic pipe welding

Electrofusion welding

ROWELD ROFUSE Sani 160/315

Universal electro-fusion welding unit for drainage pipe with welding sockets up to Ø 315 mm



Product profile

APPLICATION AREA

Universal electrofusion welding unit for PE drainage pipe fittings. For the following makes:

- 40 - 160 mm:** Geberit, Akatherm-EUR, Coes, Valsir, WAVIN-Duo, Aquatherm and Vulcathene-Euro
- 200 - 315 mm:** Valsir, Akatherm, Eurofusion, Geberit and Coes

KEY FEATURES

- Microprocessor controlled welding unit with automatic temperature and voltage compensation
- Icon-based software for intuitive and easy operation
- Visual monitoring of the welding process via large illuminated display
- Robust and impact-resistant housing (IP 54)
- Automatic welding parameter detection

TECHNICAL DATA

Input voltage:	180 - 280 V (230 V)
Frequency:	40 - 70 Hz
Output voltage:	5 A controlled
Protection class:	IP 54
Working range:	up to Ø 160 mm (Sani 160) up to Ø 315 mm (Sani 315)
Temperature range:	-5 °C up to + 40 °C
Weight:	2.4 kg (Sani 160) 3.9 kg (Sani 315)
Dimensions:	110 x 200 x 80 mm
Welding cable:	3 m

Welding in confined spaces

90° angled plugs ensure low installation height



Impact-resistant housing (IP 54)

Robust

Large illuminated display

Easy monitoring of the welding process

Intuitive and easy operation

Icon-based software control with automatic welding parameter detection

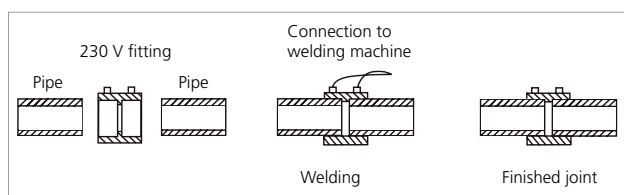
3 m welding cable

Large operating radius

90° angled plugs



Robust packaging in ROCASE



Model	kg	No.
ROWELD ROFUSE Sani 160 in ROCASE	2.4	1000002630
ROWELD ROFUSE Sani 315 in ROCASE	3.9	1000002631

ROWELD P 63 S-6 Sword

Socket welding unit Ø 20 - 63 mm



Product profile

APPLICATION AREA

Socket welding unit for use with heating spigots and heating sockets Ø 20 - 63 mm with three simultaneously usable combinations for welding sockets, pipes and fittings up to Ø 63 mm

KEY FEATURES

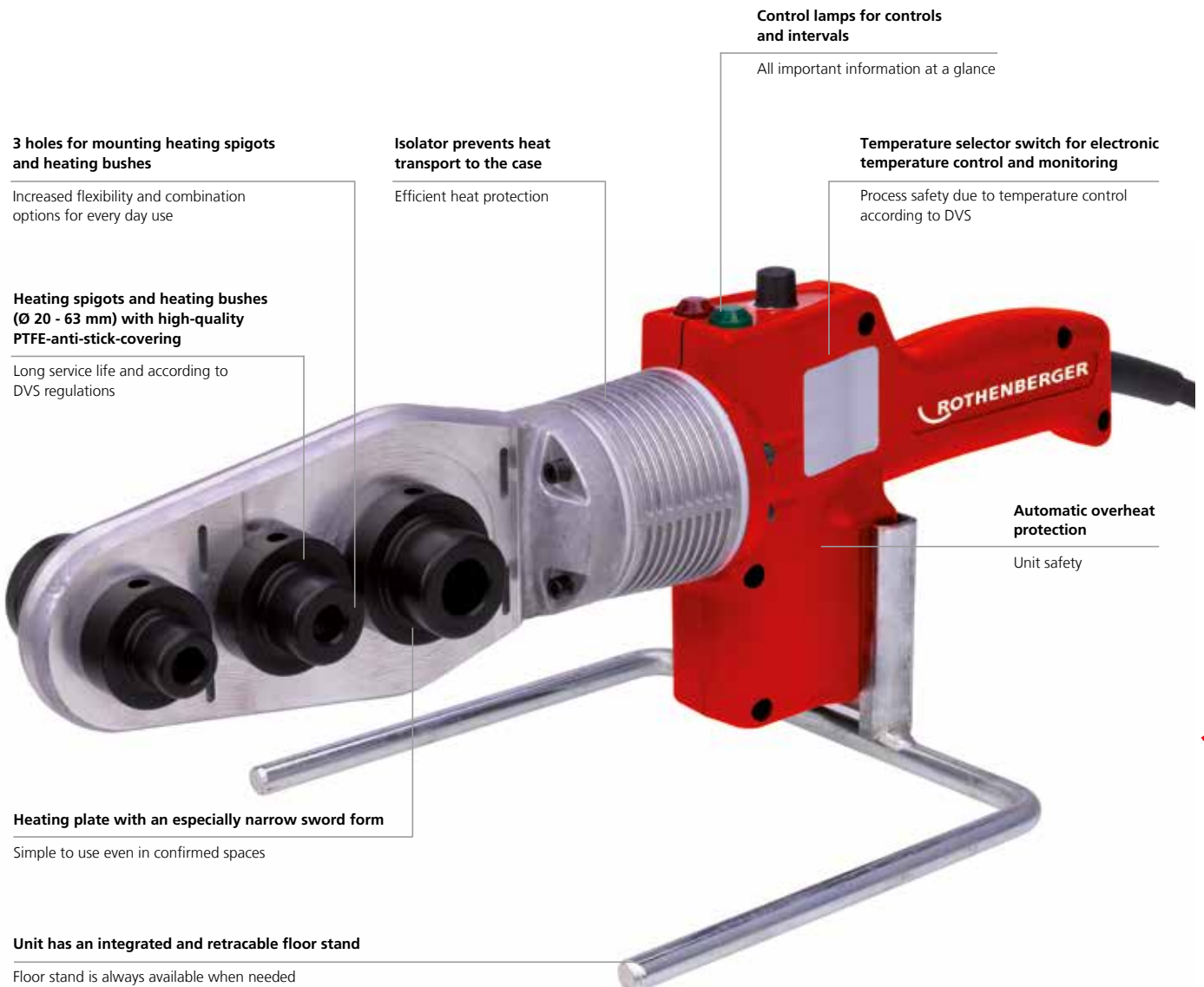
- Increased flexibility and combination options for every day use
- Long service life and according to DVS regulations
- All important information at a glance
- Safe operation with the temperature control as per DVS regulations

KEY FEATURES

- Light and handy for fatigue-free use
- Simple to use even in confined spaces
- Floor stand is available at all times

TECHNICAL DATA

Power:	800 W
Model:	Thermostatic or electronically controlled
Pipe diameter:	For sockets, pipes and fittings from Ø 20 - 63 mm
Voltage:	230 V, 50/60 Hz 110/115 V, 50/60 Hz



3 holes for mounting heating spigots and heating bushes

Increased flexibility and combination options for every day use

Heating spigots and heating bushes (Ø 20 - 63 mm) with high-quality PTFE-anti-stick-covering

Long service life and according to DVS regulations

Isolator prevents heat transport to the case

Efficient heat protection

Control lamps for controls and intervals

All important information at a glance

Temperature selector switch for electronic temperature control and monitoring

Process safety due to temperature control according to DVS

Automatic overheat protection

Unit safety

Heating plate with an especially narrow sword form

Simple to use even in confined spaces

Unit has an integrated and retractable floor stand

Floor stand is always available when needed

Plastic pipe welding

Socket welding

ROWELD P 63 S-6 Sword sets

P 63 S-6 Sets include: Heating spigots, hex key size 6 (No. 321216), socket-head screws, table mounting clamp, loor stand, plastic carrying case

Electronically controlled for a constant temperature!



Fig. P 63 S-6, thermostatically controlled



Fig. P 63 S-6, electronically controlled

Model	Working range Ø mm	Power watts	Description	kg	230 V	110/115 V
P 63 S-6 set	20, 25, 32	800	thermostatic	4.30	053892X	053894X
P 63 S-6 set	20, 25, 32, 40, 50, 63	800	thermostatic	5.30	053893X	053895X
P 63 S-6 set	20, 25, 32	800	electronically	4.30	053890X	
P 63 S-6 set	20, 25, 32, 40, 50, 63	800	electronically	5.30	053891X	
P 63 S-6 single unit		800	thermostatic	1.78	053897X	
P 63 S-6 single unit		800	electronically	1.78	053896X	

P 63 S-6 set thermostatically controlled



Secure workbench operation, integrated holder for the table mounting clamp



12

Heating spigots and sockets (Form A) for P 63 S-6

With high-quality non-stick Teflon coating with a long service life and manufactured according to DVS regulations

Working range Ø mm	g	No.
20	80	53511
25	100	53512
32	170	53513

Working range Ø mm	g	No.
40	260	53514
50	370	53515
63	600	53516



ROWELD P 125

Socket welding unit for use with heating spigots and heating sockets for Ø 16 - 125 mm, as well as adaptor plates for butt welding

Product profile

APPLICATION AREA

With three simultaneously usable welding combinations for free-handed working or workbench assembly using table mounting clamp

KEY FEATURES

- Process reliability with the temperature control according to DVS, CEN and ISO standards
- With high-quality non-stick Teflon coating, long service life and manufactured according to DVS regulations
- Electronic temperature control and monitoring, as well as prevention against unintentional temperature adjustment
- Saves time and money with quick-exchange system for heating plates
- Optimum temperature distribution over the entire working area
- 4 holes for mounting of heating spigots and heating sockets



No. 55321

Heating spigots / Heating sockets



Adaptor plate



Set (No. 55546) includes: basic unit, table mounting clamp, heating spigots / heating sockets 63, 75, 90, 100 and 125 mm, steel case

Heating spigots / Heating sockets (Form A)

Model	kg	No.	Model	kg	No.
16	0.06	55585	50	0.37	55593
18	0.08	55587	63	0.60	55594
19	0.08	55588	75	0.89	55595
20	0.08	55589	90	1.33	55596
25	0.10	55590	110	2.07	55597
32	0.17	55591	125	2.33	55598
40	0.26	55592			

Model	Power watts	mm	Control Model	kg	230 V 50/60 Hz
P 125	1,300	16 - 125	electronically	3.10	55321
P 125 set	1,300	63 - 125	electronically	17.05	55546

ROWELD HE heating plates

Heating plates for butt welding of PE, PP, PVDF and PB pipes and fittings with Ø 20 - 250 mm

Product profile

APPLICATION AREA

Plastic pipe heating plates for free-handed working or workbench assembly using table mounting clamp

KEY FEATURES

- Long service life and manufactured according to DVS regulations
- Process reliability with the temperature control according to DVS, CEN and ISO standards
- Electronic temperature control and monitoring as well as prevention against unintentional temperature adjustment
- Save time and money with quick-exchange system for heating plates



Power watts	Heating element Ø mm	Control Model	kg	230 V 50/60 Hz	110/115 V 50/60 Hz
500	120/45°	electronically	1.80	55518	55517
800	200	electronically	3.25	55316	55851
1500	300	electronically	5.35	55317	55854
	Table mounting clamp		0.45	55524	55524

ACCESSORIES

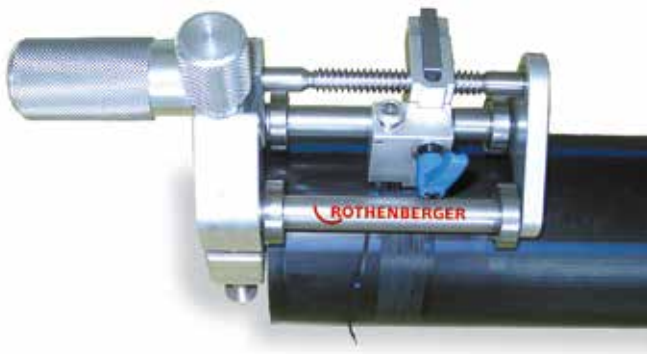
Model	kg	No.	Model	kg	No.
Table mounting clamp for P 125	0.45	55524	Floor stand for ROWELD P 125	0.44	55539
Adaptor plate for butt welding ROWELD P 125 Ø 160 mm (1 set = 2 pcs.) non-stick Teflon coating				1.15	55536

Plastic pipe welding

Socket welding

Peeling device

For secure, quick preparation of the pipe, in transport case.



Model	Ø Working range	No.
Size I	32 - 110 mm	53240
Size II	110 - 500 mm	53250

Squeezing device

- **Mechanical:**

Range of use from Ø 32 - 63 mm.
To avoid damage to the squeezed area, distance plates can be adjusted on the side.

- **Hydraulic:**

Range of use from Ø 75 - 225 mm.
Functions as mentioned above.
With this unit you can reform squeezed pipes with the help of the rounding shells.



Model	Ø Working range	No.
Squeezing device mechanical	32 - 63 mm	53200
Squeezing device hydraulic	75 - 180 mm	53210
Squeezing device hydraulic	160 - 225 mm	53220

Clamping device

For alignment and fixation of the pipe before and during the welding cycle.



Double clamp short

For alignment and fixation of the pipe before and during the welding cycle.



Quad clamps

For manufacturing standard connections with rod shaped material Ø 63 - 225 mm.



Re-Rounding clamps

For fixation of the welding depth and for rounding PE pipes after squeezing.



Model	Ø	No.
Double clamp adjustable	32 mm	53251
Double clamp adjustable	40 mm	53252
Double clamp adjustable	50 mm	53253
Double clamp adjustable	63 mm	53254
Double clamp short	75 mm	53255
Double clamp short	90 mm	53256
Double clamp short	125 mm	53258
Double clamp short	140 mm	53259
Double clamp short	160 mm	53260
Double clamp short	180 mm	53261
Double clamp short	200 mm	53262
Double clamp short	225 mm	53263
Quad clamp	63 mm	53271
Quad clamp	75 mm	53272
Quad clamp	90 mm	53273
Quad clamp	110 mm	53274
Quad clamp	125 mm	53275
Quad clamp	140 mm	53276
Quad clamp	160 mm	53277
Quad clamp	180 mm	53278
Quad clamp	200 mm	53279
Quad clamp	225 mm	53280
Re-Rounding clamp	25 mm	53281
Re-Rounding clamp	32 mm	53282
Re-Rounding clamp	40 mm	53283
Re-Rounding clamp	63 mm	53285

ROCUT UKS 160 / 355

High-performance orbital circular saw Ø 160 - 355 mm



Product profile

APPLICATION AREA

For cutting of plastic pipes made of PE, PP and PVC.
For use on the building site or in the workshop

KEY FEATURES

- Right-angled cuts with no misalignment
- Efficient and economical operation with high cutting speed
- Safe operation with saw blade guard
- Optimum pipe centering

TECHNICAL DATA

Voltage:	230 V, 50/60 Hz
Power:	1,750 W
Outer pipe diameters:	160 - 355 mm
Wall thickness pipe:	8 - 40 mm

Saw blade guard

Safe operation

Central clamping

Optimum pipe centering



No. 55505

Rubberised guide rollers

Right-angled cuts with no misalignment



Four rubberised clamping and guide rollers ensure right-angled cuts with no misalignment

Secure clamping and optimum pipe centering are guaranteed by the central trapezoidal clamping device

Transport box without saw (No. 1200000526)



Model	kg	No.
ROCUT UKS 160 / 355, complete with HM saw blade (No. 55505), without transport box	12.9	100000532
Spare HM saw blade 180 x 30 mm	0.6	55505
Transport box 700 x 350 x 500 mm	16.8	1200000526

ROCUT XL

Pipe cutter for pipes Ø 125 - 315 mm

Product profile

APPLICATION AREA

For cutting-off pipes in trenches, for making repairs or extensions

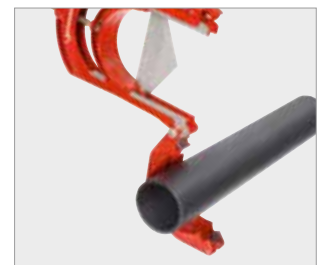
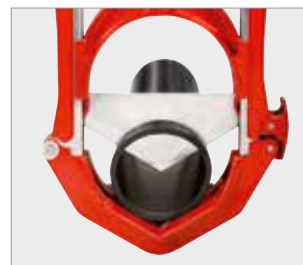
KEY FEATURES

- Can be easily adjusted anywhere at the pipe
- Robust blade made of stainless steel



An optimised cutting angle for easier pipe cutting

The lower clamp can be folded out completely. Therefore, ROCUT XL can be used at any desired position of the pipe



Replacement blade

Scope of delivery: 1 replacement blade + fastening screws

Model	mm	inch	Wall thickness	No.
ROCUT XL 125 up to 125 mm	4"		max. 11.4 mm	1500000789
ROCUT XL 225 up to 225 mm	8"		max. 18 mm	1500000790
ROCUT XL 315 up to 315 mm	12"		max. 18 mm	1500000792

Model	kg	No.
For ROCUT XL 125	0.3	1500000793
For ROCUT XL 225	0.7	1500000794
For ROCUT XL 315	2.1	1500000795

Plastic pipe welding

Cutting

Plastic pipe chamfering unit



With replaceable blades \varnothing 16 - 160 mm

For 15° outer chamfers on plastic pipe

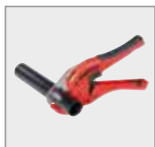




KEY FEATURES

- Flexible in use
- Wall thickness is continuously adjustable

Model	 mm	 g	No.
Chamfering unit size 1	16 - 110	720	55050
Chamfering unit size 2	32 - 160	800	55051
Spare blade size 1 and 2		30	55058

ACCESSORIES



Model		Model	
Pastic pipe shears	22	Deburrer	34
Pastic pipe cutters	27	Mounting	311
Pastic pipe cutting and chamfering tools	26		



PLASTIC PIPE WELDING TECHNOLOGY

ROWELD

Innovative and reliable highest quality pipetools and machinery can be found in the hands of excellent skilled craftsmen and on construction sites all around the globe.





Refrigeration and air-conditioning technology

System overview	276 - 277
Complete solutions	
Comissioning and maintenance	278 - 279
Evacuation and charging	280
Refrigeration circuit control	
Digital manifold	281
Analogue manifold	282
Pressure hose	283
Leak testing and locating	
Nitrogen set	284
Leak detection devices	285
Evacuation	
Vacuum pumps	286 - 288
Recovery and filling	
Refrigerant recovery device	289 - 290
Refrigerant scale	291
Accessories	
Cleaning, tools, adaptors	292 - 293
Instructions for the use of refrigerants	294
Conversion tables pressure, temperature	295

Refrigeration and air-conditioning technology

System overview

Complete solutions

ROKLIMA MULTI 4F



**ROCADDY 120 R32 Analog/
ROCADDY 120 R32 CL Analog**



**ROCADDY 120 R32 Digital/
ROCADDY 120 R32 CL Digital**



Refrigerants class A1: (R134a, R410A etc.)	✓	✓	✓
Refrigerants class A2: (R32, R1234yf etc.)	–	✓	✓
CO ₂ subcritical (R744):	–	–	✓
System size:	< 24 kW	< 24 kW	< 24 kW
Page	278 - 279	280	280

Refrigeration circuit control

ROCOOL 600



**2- and 4-ways
manifold
connection 5/16"**



**2- and 4-ways
manifold
connection 1/4"**



Pressure hoses



Refrigerants class A1: (R134a, R410A etc.)	✓	✓	✓	✓
Refrigerants class A2: (R32, R1234yf etc.)	✓	✓	–	✓
CO ₂ subcritical (R744):	✓	–	–	✓
System size:	all	all	all	all
Page	281	282	282	283

Evacuation

	ROAIRVAC R32 1.5	ROAIRVAC R32 CL 2.0	ROAIRVAC R32 3.0	ROAIRVAC R32 CL 5.0	ROAIRVAC R32 6.0	ROAIRVAC R32 9.0
						
						
Refrigerants class A1: (R134a, R410A etc.)	✓	✓	✓	✓	✓	✓
Refrigerants class A2: (R32, R1234yf etc.)	✓	✓	✓	✓	✓	✓
CO ₂ subcritical (R744):	✓	✓	✓	✓	✓	✓
Cordless:	–	✓	–	✓	–	–
System size:	< 24 kW	< 40 kW	< 74 kW	< 100 kW	< 123 kW	> 124 kW
Page	286 - 287	288	286 - 287	288	286 - 287	286 - 287

Recovery

	ROREC	ROREC PRO Digital
		
Refrigerants class A1: (R134a, R410A etc.)	✓	✓
Refrigerants class A2: (R32, R1234yf etc.)	–	✓
CO ₂ subcritical (R744):	–	–
System size:	< 24 kW	all
Page	289	290

¹⁾ More information at cordless-alliance-system.com

Refrigeration and air-conditioning technology

Complete solutions

ROKLIMA MULTI 4F

Fully automatic commissioning and maintenance of air-conditioning units and heat pumps

The innovative unit enables safe and comfortable operation on refrigeration systems. With simple menu navigation, 4 functions (4F) are automatically controlled.



R410A R22 R134a R407C R404A

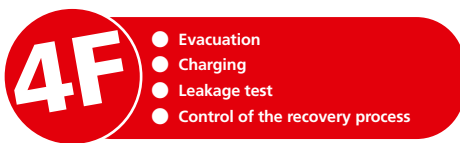
Product profile

KEY FEATURES

- Pressure resistance up to 80 bar guarantees full use with heat pumps
- Everything you need within reach
- Simple menu guidance guarantees appropriate use
- Fully automatic control gives time for parallel work
- Safe transport

TECHNICAL DATA

Weight:	17 kg
Final vacuum:	1 x 10 ⁻² mbar
Scale range:	up to 100 kg
Resolution:	10 g
Pressure hose length:	2,500 mm
Pump rating:	42 l / min



Sturdy, compact metal casing

Protects all components such as vacuum pump and scale

Integrated high vacuum pump with 42 l/min suction power

For evacuation of the system in accordance with DIN 8975

Pull-out precision digital scale up to 100 kg

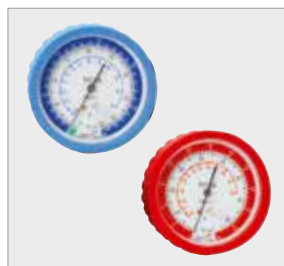
Secure stand for large and small containers

Shock-resistant low pressure and high pressure gauges for various refrigerants

Secure storage of all accessories

Pressure hoses: 2.5 m long with shut-off valve

Bottle adaptor No. 173204 / 05 for scale and 1/4" reducing pieces



Interactive 16-digit display with 4 function buttons

All required parameters can be easily entered

3 different pressure gauges "Pulse-free", class 1.6, 80 mm

Universal use on air-conditioning units with all common refrigerants and operation in the high pressure range with R410A

2 pressure hoses (2,500 mm) from the series "Plus" with ball valve

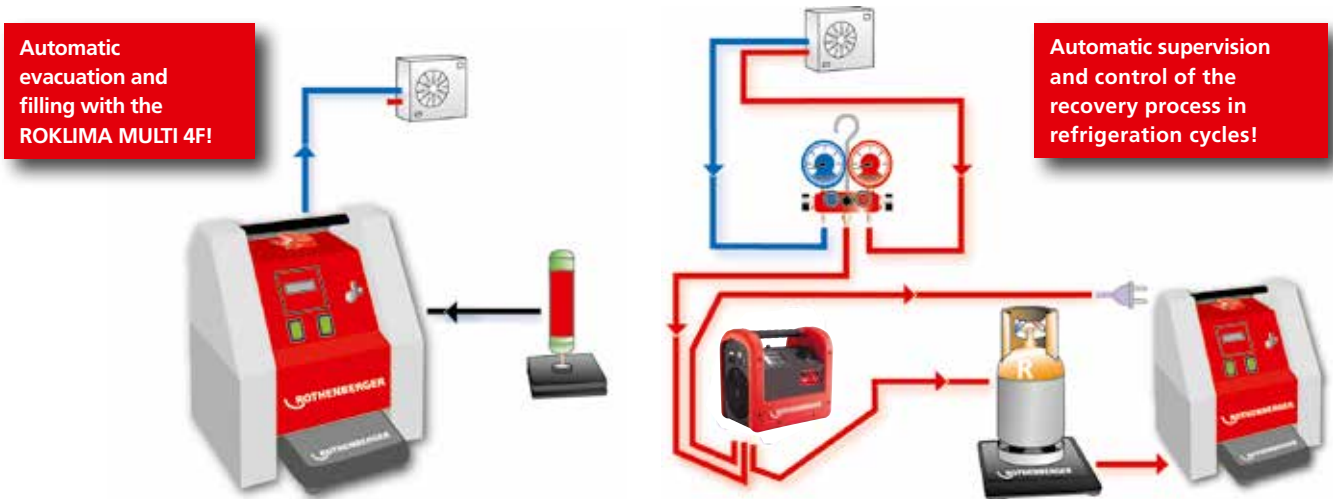
Safe and comfortable operation with refrigerants without the risk of refrigerant loss

Plastic capillary hose

Safe, leak-free filling due to shut-off valve

Refrigeration and air-conditioning technology

Complete solutions



ROKLIMA MULTI 4F in use (evacuation and charging)



Set (No. 100000138) includes: 2-stage vacuum pump, 2 low pressure gauges, 1 high pressure gauge R410A, 2 pressure hoses with ball valve à 2,500 mm, 2 bottle connection adaptors (1/4" SAE No. 173205, 5/16" SAE No. 173204), 2 reducing pieces 1/4" SAE F - 5/16" SAE M (No. 170016), precision digital scale up to 100 kg, automatic control, vacuum and pressure switch, mineral oil (No. 169200)

Model	kg	No.
ROKLIMA MULTI 4F	17.0	100000138
Reducer pieces 1/4" SAE F - 5/16" SAE M	0.1	170016

Secure storage of accessories: pressure hoses bottle adaptor, plastic capillary hose



Precision scale up to 100 kg
Resolution: 10 g
Accuracy: ± 1%



Ergonomic, compact



Light



Refrigeration and air-conditioning technology

Complete solutions



ROCADDY 120 R32 (CL) Analogue/Digital

Universal sets for evacuation and charging



Product profile

KEY FEATURES

- Everything you need within reach
- Flexible use with the individual use of the tools
- Easy to transport

Flexible application with corded or battery-powered vacuum pump

TECHNICAL DATA

- Electronic digital scale ROSCALE 120 with a weighing capacity of 120 kg and a measuring accuracy per measuring step of 5
- 2-stage high vacuum pump ROAIRVAC (corded/accumulator) with integrated vacuum gauge and solenoid check valve.
- Digital installer aid for automatic calculation of superheat and subcooling. More than 80 refrigerants stored in the unit
- 2 analogue 4-way installer aids for the common refrigerants R22, R134a, R404A, R407C and the high-pressure refrigerants R410A and R32
- Pressure hose set of 3 PLUS series hoses with shut-off valve for safe working with refrigerants
- TUBE CUTTER 35 and MINICUT II PRO for cutting tubes of diameter 6 - 35 mm to length

Sturdy plastic rolling case

Simple and comfortable transport with ample room for accessories and small parts

2-stage high vacuum pump

For evacuation and removal of all moisture residue in refrigeration systems during installation per DIN 8975

Electronic digital scale up to 120 kg with high measurement precision

Precise weighing of refrigerants



2 x analogue manifolds (ROCADDY 120 analogue)

(ROCADDY 120 analogue CL)

Mini tube cutter and pipe cutter

For cutting \varnothing 6 - 35 mm pipes to length

Bottle adaptor for 1 kg and 2 kg refrigerant bottles for connection to the scale

Secure mounting of the bottle during charging

ROCOOL 600

Automatic calculation of superheat and subcool. Optionally upgradable through attachment of a vacuum probe and a reading out function

ROCADDY 120 R32 Analog / Digital (No. 1000002560/1000002561) includes: 2-stage vacuum pump ROAIRVAC R32 1.5 (No. 1000002399), 4-way manifold (No. 170502) / 4-way manifold (No. 100001427) (Analogue), ROCOOL 600 (No. 1000000569) / clamping thermometer (No. 1000000540) (Digital), pressure hose set 5/16" SAE 1.500 mm (No. 1500000030), pressure hose set 1/4" SAE 1.500 mm (No. 1500000028), ROSCALE 120 (No. 173004), 3/8" SAE F - 1/4" SAE M (No. 89501), 2 x 5/16" SAE F - 1/4" SAE M (No. 01700RD), 5/16" SAE M - 1/4" SAE F (No. 170016), bottle connection 1/4" (No. 173205), bottle connection 5/16" (No. 173204), mineral oil (0,4 l), Tube Cutter 35 (No. 70027), Minicut II Pro (No. 70402), transport case (No. 169051)

ROCADDY 120 R32 CL Analog / Digital (No. 1000003622/1000003623) includes: 2-stage vacuum pump ROAIRVAC R32 2.0 CL* (No. 1000003229), 4-way manifold (No. 170502) / 4-way manifold (No. 100001427) (Analogue), ROCOOL 600 (No. 1000000569) / clamping thermometer (No. 1000000540) (Digital), pressure hose set 5/16" SAE 1.500 mm (No. 1500000030), pressure hose set 1/4" SAE 1.500 mm (No. 1500000028), ROSCALE 120 (No. 173004), 3/8" SAE F - 1/4" SAE M (No. 89501), 2 x [5/16" SAE F - 1/4" SAE M (No. 01700RD), 5/16" SAE M - 1/4" SAE F (No. 170016)], bottle connection 1/4" (No. 173205), bottle connection 5/16" (No. 173204), bottle connection for R32 (No. 173206), mineral oil (0,4 l), Tube Cutter 35 (No. 70027), Minicut II Pro (No. 70402), 8.0 Ah Li-HD battery (No. 1000002549), charger (No. 1000001654), transport case (No. 169051)

Model	Performance	$\frac{\text{kg}}{\Delta}$	No.		
R410A	R22	R134a	R407C	R404A	R32
ROCADDY 120 R32					
Analog	42 l/min	20	1000002560		
Digital	42 l/min	19	1000002561		

Model	Performance	$\frac{\text{kg}}{\Delta}$	No.			
R410A	R22	R134a	R407C	R404A	R507	R32
ROCADDY 120 R32						
CL* Analog	57 l/min	21	1000003622			
CL* Digital	57 l/min	20	1000003623			

ROCOOL 600

For commissioning, maintenance work and documentation of refrigeration systems of all kinds



Product profile

KEY FEATURES

- Modular system: The basic device can be fitted with the optional Red Box incl. the Data Viewer software for reading out or recording data on a PC.
- More than 80 refrigerants incl. R32 and R744 (sub-critical) are stored in the device. New refrigerants can be added later using the update function
- Simultaneous calculation of superheat and subcool
- The documentation software Data Viewer generates an automatic report based on the data recorded. Ideal for handing out to the customer (client)
- An external Pirani vacuum probe allows reading of the vacuum where the most precise measurement is possible: directly at the refrigeration system

TECHNICAL DATA

Pressure display:	bar, psi, Kpa, MPa
Temperature display:	°C, °F
Vacuum display:	Micron, mbar, mmHg, Pa, mTorr
Power source:	9 V battery, 550 mAh
Screen size:	4.1/3" / 11 cm
Pressure measurement range:	-1 up to 60 bar
Precision (at 22 °C):	± 0.5% fs
Temperature measurement range:	-50 °C to +200 °C
Working temperature:	-10 °C to +50 °C
Connections:	4x 1/4" SAE
Max. recording time:	12h (device), 96h (red box)

An absolute all-rounder due to the unique modular system!

Large screen

All important data at a single glance. Strong backlight for dark environment

Connection for the temperature sensor T1

For automatic measurement of superheat data

Connection for the external vacuum probe

For very precise measurement of the vacuum level directly at the refrigeration system

Pressure sensors "Made in Germany"

Precise measurement from -1 to 60 bar

T-connection with Schrader valve 1/4" SAE

3-way function: Evacuation and filling without changing a hose

Y-connections 1/4" SAE

A connection and sealing plug in one. Simple transport of hoses when not in operation

Solid and non-tacky rubber coating

Prevents shock damages and allows a safe handling

Connection for the temperature sensor T2

For automatic measurement of subcool data

Green and red LEDs

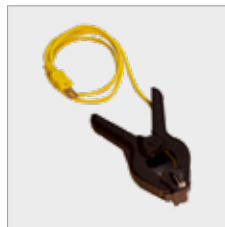
An optical signal is displayed once an adequate vacuum level is reached or leakage in the system and also a warning of overpressure



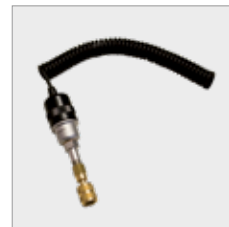
Connection of the Red Box

To record data for up to 96 hours and independent read out of data at a PC

Temperature sensor for a pipe diameter of up to Ø 32 mm



External vacuum probe for very precise measurement of the vacuum



Set (No. 100000569) includes: ROCOOL 600, 1 temperature sensor

Set (No. 100000570) includes: ROCOOL 600, 2 temperature sensors, carry case

Set (No. 100000572) includes: ROCOOL 600, 2 temperature sensors, red box and data viewer software, carry case

Set (No. 100000539) includes: Red box, data viewer software, connection cable, external power supply

Model	No.
Set with 1 temperature sensor (in the blister)	100000569
Set with 2 temperature sensors (in the case)	100000570
Set with 2 temperature sensors, red box, data viewer software (in the case)	100000572

Model	No.
Red box, software, connection cable, external power supply	100000539
Temperature sensor	100000540
Vac probe	100000541

¹⁾ Complete terms and conditions at rothenberger.com/roservice
RO SERVICE+ only valid in participating countries

Refrigeration and air-conditioning technology

Refrigeration circuit control

Analogue manifolds

2- and 4-way manifolds



Pressure gauge Ø 80 mm, with pulse-dampening class 1.6

Easy-to-read, high precision display

Large hand valve with colour coding

Light, secure and precise opening and closing of the diaphragm valve, maintenance free

Valve sets



Pressure gauge with shock-proof rubber protector

Protects against damage

Valve body made of aluminium with gauge glass

Sturdy despite low weight

2-way manifold



Model	ND*/bar	HD*/bar	kg	No.
R22	R134a	R407C	R404A	
2-way, 1/4" SAE	-1 up to 17	0 - 34	0.7	170501
4-way, 1/4" SAE	-1 up to 17	0 - 34	0.9	170502
R410A	R32			
2-way, 5/16" SAE	-1 up to 30	0 - 60	0.7	100001426
4-way, 5/16" SAE	-1 up to 30	0 - 60	0.9	100001427

*LP = Low pressure manifold, *HP = High pressure manifold

Model	No.
Blue rubber protector for manifold	170545
Red rubber protector for manifold	170546
Valve sets for manifold	170547

Manifold sets

Manifold sets and pressure hoses

2-way manifold (for 170600 and 170607)

4-way manifold (for 170601, 170606, 170602 and 170608)

Durable and highly precise tool



No. 170602

Pressure hose with ball valve "Plus" (only for 170602 and 170608)

No loss of refrigerant

Sets include: manifold, pressure gauge with Ø 80 mm, "Pulse-free", class 1.6, 3 x 1,500 mm pressure hoses, plastic carrying case

Model	kg	No.		
2-way "Standard"				
R22	R134a	R407C	R404A	
Manifold set 2-way "Standard"	2.7	170600		
R410A	R32			
Manifold set 2-way "Standard"	2.7	170607		
4-way "Standard"				
R22	R134a	R407C	R404A	
Manifold set 4-way I "Standard"	2.8	170601		
R410A	R32			
Manifold set 4-way I "Standard"	2.8	170606		
4-way "Plus"				
R22	R134a	R407C	R404A	
Manifold set 4-way II "Plus"	2.8	170602		
R410A	R32			
Manifold set 4-way II "Plus"	2.8	170608		
Plastic carry case	1.4	171505		

3-piece pressure hose sets

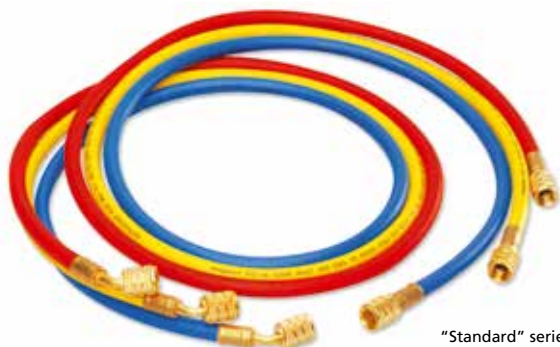
Available in "Standard" and "Plus"



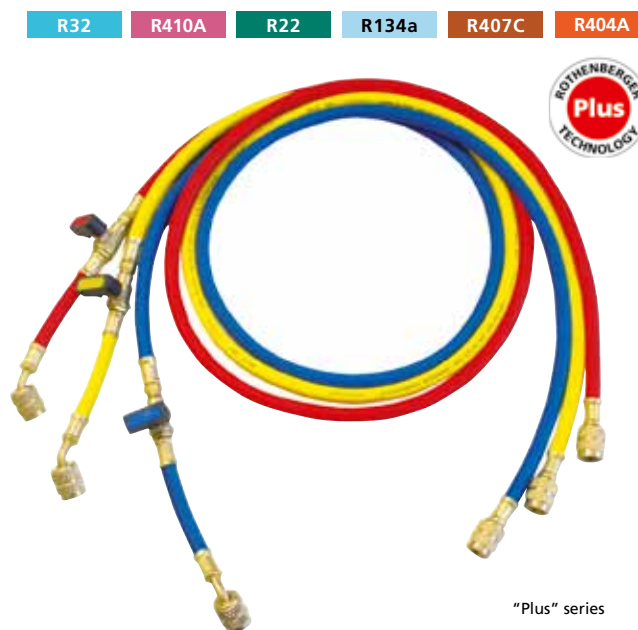
Product profile

KEY FEATURES

- No confusion and safe use with the colour coding (blue, red, yellow)
- Teflon seal with up to 10x longer service life compared to neoprene seal
- Working pressure 60 bar / burst pressure 300 bar. This is an 8% better pressure resistance as previously



"Standard" series



"Plus" series

Pressure hose from the series "Standard"

Model	Connection	L mm	No.
Vacuum hose	3/8" SAE	1,500	1500000032
R22 R134a R407C R404A			
Set of 3 pressure hoses	1/4" SAE	1,500	1500000024
Pressure hose yellow	1/4" SAE	1,500	1500000025
R410A R32			
Set of 3 pressure hoses	5/16" SAE	1,500	1500000026
Pressure hose yellow	5/16" SAE	1,500	1500000027

Pressure hose from the series "Plus" with ball valve

Model	Connection	L mm	No.
R22 R134a R407C R404A			
Set of 3 pressure hoses	1/4" SAE	1,500	1500000028
Pressure hose yellow	1/4" SAE	1,500	1500000029
R410A R32			
Set of 3 pressure hoses	5/16" SAE	1,500	1500000030
Pressure hose yellow	5/16" SAE	1,500	1500000031

Tool set Climate I + II

Practical tool set with all tools required

For installation and maintenance of air-conditioning units and heat pumps

Product profile

APPLICATION AREA

- Monitor temperature and pressure
- Quality hoses with high bursting pressure
- Pipe cutter for all pipe cross-sections from 3 - 35 mm (1/8" - 1.1/8")
- Measurement of ambient and ventilator air temperature
- Clean, kink-free bending of all common pipe cross-sections
- Optimum flaring connections for all types of air-conditioners

Set Climate I (No. 170604) includes: 2-way manifold (No. 170501), set of pressure hoses standard 1/4" SAE, TUBE CUTTER 35 C (No. 070027C), MINICUT pipe cutter (No. 070401C), thermometer, set of bending springs 3/8" - 1/2" - 5/8", universal flaring tool (No. 222601), plastic case

Set Climate II (No. 170605) includes: 2-way manifold (No. 100001426), set of pressure hoses standard 5/16" SAE, TUBE CUTTER 35 C (No. 070027C), MINICUT pipe cutter (No. 070401C), thermometer, set of bending springs 3/8" - 1/2" - 5/8", reeling flaring tool (No. 222402), plastic case

Model	kg	No.
Tool set Climate I	2.3	170604
Tool set Climate II	2.4	170605

R32 **R22** **R134a** **R407C** **R404A**



The ideal introduction into a whole new area of business!



No. 170604

Refrigeration and air-conditioning technology

Leak testing and locating

Nitrogen set

Multiple uses for refrigeration systems



Product profile

APPLICATION AREA

- Pressure and leak test with nitrogen
- Flushing of the installation
- Nitrogen admission during soldering to prevent scale formation

Ideal for split air-conditioning units and heat pumps!



No. 259060

13


5/16" SAE adaptor for connecting to R410 units



Bottle adaptor for connecting 950 cm³ bottles



Set (No. 259060) includes: pressure reducing valve, connection hose, bottle adaptor, pressure gauge, nitrogen bottle and plastic case

Model		No.
Nitrogen set with bottle (950 cm ³)		259060
Nitrogen bottle, each 950 cm ³	6	259008
Filling hose with pressure gauge		259010
Connection 5/16" SAE internal, 1/4" SAE external		01700RD

ROLEAK Pro

Electronic leak detection device for locating leaks in refrigeration systems (3 g/a)



R410A	R22	R134a	R407C	R404A	R507A	R32
-------	-----	-------	-------	-------	-------	-----

Product profile

KEY FEATURES

- Durable and highly sensitive sensor tip with a leak detection rate of 3 g/a within 3 seconds
- Suitable for R32
- Simple determination of the refrigerant concentration
- Adjustment of the sensor tips zero measurement point for simple detection of the leak
- Reference leak for functionality test included
- Easy accessibility of even hard to reach leaks

TECHNICAL DATA

Leak status:	LED display
Sensor length:	40 cm
Leak detection rate:	3 g/a within 3 seconds
Weight:	400 g
Working temperature:	0 °C up to 40 °C
Voltage:	6 V (4 AA batteries included)

Audio signal

Comfortable use

7 LEDs

Simple determination of the refrigerant concentrate with the coloured shading

RESET - button

Adjusts to the sensor tip zero point setting for simple leak location

3 different sensitivity levels

Exact and fast location of the leak

40 cm long, flexible sensor

Easy access in hard-to-reach places



No. 150002241

Model	No.
ROLEAK Pro in plastic case	150002241

¹⁾ Complete terms and conditions at rothenberger.com/roservice
RO SERVICE+ only valid in participating countries

Refrigeration and air-conditioning technology

Evacuation

ROAIRVAC R32

Two-stage vacuum pump

For evacuation in accordance with DIN 8975 with vacuum gauge and solenoid valve



Product profile

KEY FEATURES

- Solenoid check valve to protect the refrigeration system from oil contamination during power outage
- Vacuum gauge with integrated drag indicator enables simple and quick control of the evacuation process
- Protects the integrated components with the light and high-quality casing
- Gas ballast valve for reduction of water vapour in the oil container
- Special filter reduces oil mist on exhaust vent

KEY FEATURES

- Gauge-glass enables easy oil-stand monitoring
- Fast filling of oil without spilling, no special funnel is necessary
- Easy access to the oil drain plug makes emptying quick
- Thermal switch protects the unit from the motor overheating
- Standard 1/4" SAE connection as well as 5/16" SAE and 3/8" SAE adaptor included in delivery
- Removable cable prevents cable damage



Gas ballast valve

Reduction of water vapour in the oil container, guarantees higher evacuation power and service life

Special filter

Reduces oil mist on exhaust vent

Light and high-quality casing

Protects the integrated components

Ergonomic handle

Light, compact and easy to transport

Removable cable

Prevents cable damage

Integrated vacuum gauge

Simple and fast control of the evacuation process

Integrated solenoid valve

Prevents backwash of oil into the refrigeration system

Four-pole motor*

Increased torque and long service life
* (only with ROAIRVAC R32 1.5, 3.0 and 6.0)



13

1/4" SAE standard connection with adaptors for 5/16" SAE and 3/8" SAE



Optimal positioned viewing glass and oil drains for simple draining of the oil



Practical: operating instructions always within view



ROAIRVAC R32 Series

Two-stage rotary vane pump for evacuation
in accordance with DIN 8975

Type	ROAIRVAC R32 1.5	ROAIRVAC R32 3.0	ROAIRVAC R32 6.0	ROAIRVAC R32 9.0
No.	1000002399	1000002713	1000001231	1000002714
Pump rating	1.5 CFM / 42 l/min / 2.5 m ³ /h	3.0 CFM / 85 l/min / 5.1 m ³ /h	6.0 CFM / 170 l/min / 10.2 m ³ /h	9.0 CFM / 255 l/min / 15.3 m ³ /h
Vacuum stages	2	2	2	2
Final vacuum	15 micron / 0.02 mbar	15 micron / 0.02 mbar	15 micron / 0.02 mbar	15 micron / 0.02 mbar
Motor rating	190 W / 1720 r/m	250 W / 1720 r/m	550 W / 1720 r/m	750 W / 3440 r/m
Voltage	230 V	230 V	230 V	230 V
Frequency	50 Hz / 60 Hz	50 Hz / 60 Hz	50 Hz / 60 Hz	50 Hz / 60 Hz
Connection	1/4"	1/4"	1/4"	1/4"
with adaptor	5/16" SAE M / 3/8" SAE M	5/16" SAE M / 3/8" SAE M	5/16" SAE M / 3/8" SAE M	5/16" SAE M / 3/8" SAE M
Oil capacity	250 ml	330 ml	580 ml	590 ml
Weight	10.1 kg	11.9 kg	17.3 kg	18.4 kg
Manifold Ø	45 mm	50 mm	80 mm	80 mm

Future-proof product for the
increased use of R32 refrigerants



ROAIRVAC R32 1.5 (42 l/min)



ROAIRVAC R32 3.0 (85 l/min)



ROAIRVAC R32 9.0 (255 l/min)

Mineral oil is included in all
pump deliveries



ROAIRVAC R32 6.0 (170 l/min)



ROAIRVAC R32 1.5 - vacuum pump in use with the digital manifold ROCOOL 600



Scope of delivery ROAIRVAC: vacuum pump with 1/4", 5/16" SAE and 3/8" SAE
connections, plastic bottle with mineral oil

Model	Performance	kg	No.
ROAIRVAC R32 1.5	42 l/min	10.1	1000002399
ROAIRVAC R32 3.0	85 l/min	11.9	1000002713
ROAIRVAC R32 6.0	170 l/min	17.5	1000001231
ROAIRVAC R32 9.0	255 l/min	18.4	1000002714
Mineral oil 1 litre			169200

Refrigeration and air-conditioning technology

Evacuation

ROAIRVAC R32 2.0/5.0 CL

Battery driven two-stage vacuum pump



Product profile

KEY FEATURES

- Compatible with CAS battery system
- Solenoid check valve to protect the refrigeration system from oil contamination during power outage
- Protects the integrated components with the light and high-quality casing
- Gas ballast valve for reduction of water vapor in the oil container
- Special filter reduces oil mist on exhaust vent
- Gauge-glass enables easy oil-stand monitoring
- Fast filling of oil without spilling, no special funnel is necessary
- Easy access to the oil drain plug makes emptying quick
- Thermal switch protects the unit from the motor overheating
- Standard 1/4" SAE connection as well as 5/16" SAE and 3/8" SAE adaptor included in delivery

TECHNICAL DATA

	R32 2.0 CL	R32 5.0 CL
Pump rating:	2,0 CFM / 57 l/min	5,0 CFM / 142 l/min
Vacuum stages:	2	2
Final vacuum:	23 micron	15 micron
Motor power:	185 W / 3,600 r/m	550 W / 1,800 r/m
Voltage:	18 V	18 V
Connection:	1/4"	1/4"
with Adaptor:	5/16" SAEM / 3/8" SAEM	5/16" SAEM / 3/8" SAEM
Oil capacity:	180 ml	350 ml

Gas ballast valve

Reduction of water vapour in the oil container, guarantees higher evacuation power and service life.²⁾

Special filter

Reduces oil mist on exhaust vent

Light and high-quality casing

Protects the integrated components

Ergonomic handle

Light, compact and easy to transport

Battery LED indicator

Easy management of remaining battery power

CAS battery

Compatible with more than 200 power tools from 20 manufacturer

Brushless Motor

For wear-free work and longer machine life



No. 1000003229



No. 1000003231



No. 1000003230



No. 1000003233

13

One battery, many solutions.

Founded in 2018, 20 manufacturers are already using the Cordless Alliance System, CAS for short, as of September 2021. CAS is the first cross-manufacturer battery system.

Model	kg	No.
ROAIRVAC R32 2.0 CL	3.7	1000003229
ROAIRVAC R32 2.0 CL incl. battery Li-HD, 8.0 Ah 18 V and charger in ROBUCKET	6.1	1000003230
ROAIRVAC R32 5.0 CL	7.5	1000003231
ROAIRVAC R32 5.0 CL incl. battery Li-HD, 8.0 Ah 18 V and charger in ROBUCKET	10.5	1000003233

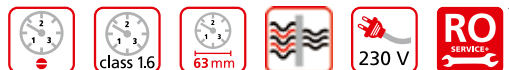
¹⁾ Complete terms and conditions at rothenberger.com/roservice
RO SERVICE+ only valid in participating countries

²⁾ Only applies to ROAIRVAC R32 5.0 CL

ROREC

Refrigerant recovery device

Compact, portable device for recovery and recycling refrigerants of all kinds



Product profile

KEY FEATURES

- 4-pole motor guarantees the durability of the machine
- Low noise and vibration emission thanks to the compact design
- Intuitive handling makes it simple and safe to use
- Maintenance-free operation through the oil-free compressor
- Emptying of the device in order to work with different refrigerants with the PURGE function
- Simple transport and use with the light and compact plastic casing

TECHNICAL DATA

Suitable for:	all refrigerants of the type CFC-HCFC-HFC
Capacity:	gaseous: 0.26 kg / min fluid: 1.85 kg / min push/pull: 6.22 kg / min
Electrical data:	230 V / 50 - 60Hz
Power:	370 W
High pressure switch:	38.5 bar
Dimensions:	490 x 244 x 353 mm
Weight:	17 kg

Ideal for mono and multi-split air-conditioning units and heat pumps!

Integrated high pressure switch

Protects the integrated components

PURGE function

Emptying of refrigerant residue in the unit (self-cleaning mode)

Simple use

Controlled dosage of the refrigerant supply

RESET Button

Reset of the pressure shut-off

Removable cable

Prevents cable damage

Oil-free compressor

Maintenance-free operation

Thermal switch

Protects the unit from overheating

Light and compact plastic casing

Simple transport and use

4-pole motor

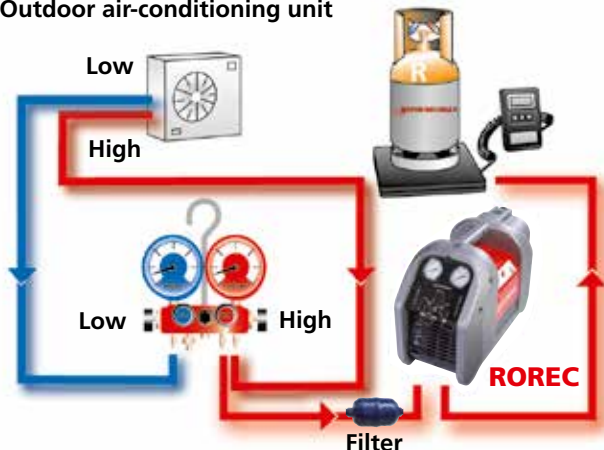
Increased torque and service life



Recovery of refrigerant

Exemplary:

Outdoor air-conditioning unit



Simple and precise reading with the glycol filled pressure gauge



Practical storage compartment for accessories on the back



Model	Connected Load	kg	No.
ROREC	370 W	17.0	168605
Filter		0.12	168713

¹⁾ Complete terms and conditions at rothenberger.com/roservice
RO SERVICE+ only valid in participating countries

Refrigeration and air-conditioning technology

Recovery and filling

ROREC PRO Digital

Refrigerant recovery device

Lightweight recovery unit for the recovery of refrigerants of the classes A1, A2L and A2 (incl. R32), suitable for all unit sizes thanks to its high recovery rate.



Product profile

KEY FEATURES

- Suitable for refrigerants of the classes A1, A2L and A2 (incl. R32)
- Compact design with a weight of less than 12 kg
- Digital display and one-knob control
- Maintenance free operation with the oil-free 2-piston compressor
- 4-pole motor guarantees the durability of the machine
- Automatic shut-off and automatic restart once the pressure increases again
- Emptying of refrigerant residues with the PURGE function

TECHNICAL DATA

Recovery rate:	gaseous:	0.5 kg / min; 30 kg / h
	fluid:	3.5 kg / min; 210 kg / h
	push/pull:	9.5 kg / min; 570 kg / h
Power supply:	230 V / 50 - 60 Hz	
Power:	730 W	
High pressure switch:	38.5 bar	
Product dimensions:	380 x 250 x 350 mm	
Weight:	12 kg	

Digital display

Clearly structured display of the measured pressure values

Low pressure switch

Automatic shut-off and automatic restart once the pressure increases again



Oil-free 2-piston compressor

Very high recovery rate with maintenance free operation



Practical storage compartment

Storage of accessories in the back

Shoulder strap for transport over longer distances



Clearly structured digital display



13

Model	kg	No.
ROREC PRO Digital	12.0	1500002637
Filter	0.12	168713

ROSCALE 120

Electronic refrigerant scale

Precise, easy to handle refrigerant scale for filling and evacuation processes with a maximal weight capacity of 120 kg



Product profile

KEY FEATURES

- Resolution of 5 g enables very precise filling
- Weight capacity sufficient for all common refrigerant bottles
- Cable connection enables comfortable use in every situation
- Bottle adaptor for connecting small refrigerant bottles (1 l and 2 l bottles)
- Refrigerant bottles of all sizes have enough space
- Large LCD display for comfortable reading of the result
- Simple use

TECHNICAL DATA

Weight capacity:	120 kg or 264 lbs
Accuracy:	+/- 0.5%
Resolution:	5 g / 0.2 oz.
Working temperature:	-10° C up to +49° C / 14 up to +120° F
Connection:	1/4" SAE for 1 - 2 lit. bottles
Battery:	9 V
Platform size:	230 x 230 x 53 mm
Weight:	3.28 kg



ROSCALE 120 in carrying case

Set (No. R17300416) includes: ROSCALE 120, 9 V battery, carrying case

Model	kg	No.
ROSCALE 120	3.28	R17300416

Refrigerant for air-conditioning units

Non-chlorinated refrigerant of the HFC group in practical 40 bar steel bottles (bursting pressure: 165 bar) TÜV seal No. 0036-043/03D and TPED accepted as per 99/36/CE

Product profile

KEY FEATURES

- Light and practical for use on building-sites
- 1 and 2 litre steel bottles, rent-free and easy disposal
- Flat base for increased standing stability
- Ease of clean up after removing of the valve

Standardised SAE thread on all bottle valves

Universal application

Refillable bottles

Full flexibility for the user



Model		No.
R410A	Refrigerant R410A in cardboard packaging	
	1 l steel bottle 5/16" SAE, 800 g	6 170912
	2 l steel bottle 5/16" SAE, 1,600 g	4 170932
R32	Refrigerant R32 in cardboard packaging	
	1 l steel bottle 1/2" SAE, 780 g	6 170960
	2 l steel bottle 1/2" SAE, 1,800 g	4 170961



Refrigeration and air-conditioning technology

Accessories

SANIFRESH


Deodorising cleaning spray



Product profile

KEY FEATURES

- Removes the threat of disease and allergies – practical and ecologically friendly solution for removing mites, dust, bacteria and spores
- Spray is applied directly to affected surface
- Economical spray can with spray nozzle and spray tube
- Removes unpleasant odours. Pleasant mint smell

Model		Volume	No.
Sanifresh (contains 12 bottles)	1	400 ml	85800

Bottle connection and adaptors

For refrigerant bottles

For use with new refrigerant bottles on existing equipment



Model	No.
Adaptor, 1/4" connection	173205
Adaptor, 5/16" connection	173204
Adaptor, W21.8 x 1/4" SAE M connection with seal for 2 l sized bottles	170950
Adaptor W21,8 LEFT x 1/4" SAE M connection for combustible refrigerants like R32	150003381
Adaptor 1/2" LEFT - 5/16" SAE M connection	173206
Adaptor, 1/4" SAE M - 3/8" SAE F connection	89501
Adaptor, 3/8" SAE M - 1/4" SAE F connection	89503
Adaptor, 1/4" SAE F - 5/16" SAE M connection	170016
Adaptor, 1/4" SAE M - 5/16" SAE F connection with valve trigger	01700RD

Torque wrench set

For proper tightening of flange connections

Set with adjustable torque wrench (10 - 70 Nm) and 6 spanner inserts sizes 17, 22, 24, 26, 27 and 29 mm for flange connections on 1/4", 3/8", 1/2" and 5/8" pipe lines **according to DIN EN 378-2 : 2012-08**



Fix with torque urgently necessary!

7-piece set (No. 175001) includes: spanner wrench sizes 17, 22, 24, 26, 27, 29 mm, torque wrench, carrying bag

Ø	Spanner width	Locking torque
1/4" / 6 mm	17 mm	14 - 18 Nm
3/8" / 10 mm	22 mm	33 - 42 Nm
1/2" / 12 mm	24 mm	50 - 62 Nm
1/2" / 12 mm	26 mm	50 - 62 Nm
5/8" / 15/16 mm	27 mm	63 - 77 Nm
5/8" / 15/16 mm	29 mm	63 - 77 Nm

Model		No.
Torque wrench set, 7 pcs.	1.7	175001

13





Schrader valve tool

Product profile

KEY FEATURES

- For exchanging the Schrader valve on air-conditioners under pressure, without having to recover the unit
- For safe and easy change of spring insert of the Schrader valve tool
- With safety thread for risk-free use with R410A

Model No.

Schrader valve tool in plastic carrying case **87800**



Plate fin comb

Product profile

KEY FEATURES

- For straightening the plate fins of heat-exchangers
- 6 different sizes in one tool

Model Product dimensions No.

Plate fin comb 8 - 9 - 10 - 12 - 14 - 15 fins per inch **224500**



Refrigeration and air-conditioning technology

General instructions for the use of refrigerants

Refrigerant data from CFC-alternative refrigerants

Refrigerant	Composition	ODP	GWP	Temperature glide
R22 (HFKW refrigerant)	CHCLF2	0.05	1,810	–
R134a (HFKW-chlorine-free refrigerant)	CF3CH2F	0	1,430	–
R32 (HFKW-chlorine-free refrigerant)	CH2F2	0	675	–
R404A (HFKW-chlorine-free blends)	52% R143a, 44% R125, 4% R134a	0	3,922	–
R507 (HFKW-chlorine-free blends)	50% R143a, 50% R125	0	3,985	–
R407C (HFKW-chlorine-free blends)	23% R32, 25% R125, 52% R134a	0	1,774	7.5K
R410A (HFKW-chlorine-free blends)	50% R32, 50% R125	0	2,088	0.2K

ODP = Ozone Depletion Potential (degree in which the ozone layer is destroyed)

GWP = Global Warming Potential (degree in which it contributes to the greenhouse effect)

Instructions for safe and proper use of the refrigerants:

Refrigerant:

- Wear protective gloves and safety goggles
- Do not let refrigerant come in contact with skin
- Do not inhale high concentrations of vapours
(Lack of oxygen causes a narcotic effect and is a danger to life)
- Do not smoke around refrigerant
- Working place / room must be thoroughly aired, if necessary extracted

Refrigerant bottles:

- Secure against accidents, do not throw
- Do not expose to direct sunlight and do not place near radiators or other heat sources
- Do not use open flame
- Do not disassemble or remove valves
- Damaged bottles need to be properly returned
- Close empty containers

Air-conditioners:

- Air-conditioner leaks need to be repaired immediately
- Do not allow refrigerant to leak while filling or doing maintenance work
- In high concentrations (for example pipe burst), leave the room and do not enter again until it has been properly ventilated
- Only do brazing work together with protective nitrogen gas and only in well ventilated areas

Flare connections

Normal flare size in accordance with JIS B8607:2008

Flare outer diameter in relationship to the pipe diameter

Pipe outer diameter mm / inch	Metric	Wall thickness mm / inch	Flare outer diameter with R22-, R134a-, R404-, R407C air-conditioners	Flare outer diameter with R410A air-conditioners
6 mm	–	1 mm	8.5 mm	9.1 mm
8 mm	–	1 mm	11.1 mm	11.1 mm
10 mm	–	1 mm	13.6 mm	13.2 mm
12 mm	–	1 mm	15.3 mm	16.5 mm
16 mm	–	1 mm	19.5 mm	19.2 mm
18 mm	–	1 mm	22.0 mm	22.7 mm
1/4"	6.35 mm	0.35"	9.0 mm	9.1 mm
5/16"	7.94 mm	0.35"	11.0 mm	11.1 mm
3/8"	9.52 mm	0.35"	13.0 mm	13.2 mm
1/2"	12.70 mm	0.35"	16.2 mm	16.6 mm
5/8"	15.88 mm	0.35"	19.4 mm	19.7 mm
3/4"	19.05 mm	0.35"	23.3 mm	24.0 mm

Refrigeration and air-conditioning technology

Conversion table pressure, temperature

Conversion table pressure

mbar	Micron	TORR	mm HG Vakuum
10	7,516	7.5	752
5	3,759	3.6	756
2	1,503	1.5	758
1	752	0.75	759
0.5	376	0.36	
0.4	300	0.30	
0.3	225	0.23	
0.2	150	0.15	
0.1	75	0.08	
0.09	68		
0.07	53		
0.06	45		
0.05	38		
0.04	30		
0.03	22		
0.02	15		
0.01	8		

Conversion table temperature

Conversion from °C in °F: °C x 1,8 + 32 = °F

Conversion from °F in °C: (°F-32) : 1,8 = °C

°C	°F	°C	°F	°F	°C	°F	°C
100	212	30	86	212	100	70	21
95	203	25	77	200	93	60	16
90	194	20	68	190	88	50	10
85	185	15	59	180	82	40	4
80	176	10	50	170	77	30	-1
75	167	4	39	160	71	20	-7
70	158	0	32	150	66	10	-12
65	149	-10	14	140	60	0	-18
60	140	-20	-4	130	54	-10	-23
55	131	-30	-22	120	49	-20	-29
50	122	-40	-40	110	43	-30	-34
45	113	-50	-58	100	38	-40	-40
40	104	-60	-76	90	32	-50	-46
35	95	-70	-94	80	27	-60	-51
						-70	-58
						-80	-66
						-90	-74
						-100	-82
						-110	-90
						-120	-98
						-130	-106
						-140	-114
						-150	-122
						-160	-130
						-170	-138
						-180	-146
						-190	-154
						-200	-162
						-210	-170
						-220	-178
						-230	-186
						-240	-194
						-250	-202
						-260	-210
						-270	-218
						-280	-226
						-290	-234
						-300	-242
						-310	-250
						-320	-258
						-330	-266
						-340	-274
						-350	-282
						-360	-290
						-370	-298
						-380	-306
						-390	-314
						-400	-322
						-410	-330
						-420	-338
						-430	-346
						-440	-354
						-450	-362
						-460	-370

Common threads

UNF-Thread	SAE-Thread	Outer diameter (max. mm)	Internal diameter (min mm)	Lodes per inch	Increment (mm)
7/16" - 20	1/4"	11.079	9.738	20	1.270
1/2" - 20	5/16"	12.667	11.328	20	1.270
5/8" - 18	3/8"	15.839	14.348	18	1.411
3/4" - 16	1/2"	19.012	17.330	16	1.588
7/8" - 14	-	22.184	20.262	14	1.814
7/8" - 14	5/8"	22.184	20.262	14	1.814
1" - 14	3/4"	25.357	23.437	14	1.814
11/16" - 14	-	26.947	25.024	14	1.814
11/8" - 12	-	28.529	26.284	12	2.117
11/4" - 12	7/8"	31.704	29.459	12	2.117
13/8" - 12	-	34.877	32.634	12	2.117
11/2" - 12	1"	38.052	35.809	12	2.117



*Detailed guarantee terms at <https://rothenberger.com/gb-en/5-year-replacement-warranty>
(Only in participating countries)



General purpose tools

System overview	298 - 299
Pliers	
Water pump pliers	302 - 305
Pliers sets	306
Corner pipe wrenches	307
One-handed pipe wrenches, chain pipe wrenches	308 - 309
Grip pliers, strap and fittings wrenches	310 - 311
Installation wrenches	
UNI stepped key set	312
Sanitary four way	312
Valve key	313
Open-ended, hinged ratchet wrenches	314 - 315
Screwdrivers	316 - 317
Installation aids	
Spirit levels, cartridge extractor sets	318
Tap reseating tool	319
Metal crimping, combination and electrical pliers	319 - 320
Cordless drill driver	321
Drill bits	322 - 323, 328
Cordless impact wrench	324
Cordless angle grinder	325
Cutting and grinding discs, chisels	326
Cordless rotary hammer	327
Cordless LED lamp	328
CAS battery packs and charger	329
Hammers, chisels, punches	330
Vices	331
Workbenches	332
General aids and tool bags	333 - 334
Case system	335 - 337

General purpose tools

System overview

ROGRIP pliers

	ROGRIP M 7" 1K	ROGRIP M 7" 2K	ROGRIP M 10" 1K	ROGRIP M 10" 2K	ROGRIP F 7" 1K	ROGRIP F 7" 2K
						
Working range:	Ø 43 mm (1.1/4")	Ø 43 mm (1.1/4")	Ø 60 mm (2")	Ø 60 mm (2")	Ø 43 mm (1.1/4")	Ø 43 mm (1.1/4")
Length:	185 mm (7")	185 mm (7")	254 mm (10")	254 mm (10")	185 mm (7")	185 mm (7")
Weight:	245 g	255 g	490 g	490 g	215 g	227 g
Material:	Chrome vanadium steel	Chrome vanadium steel	Chrome vanadium steel	Chrome vanadium steel	Chrome vanadium steel	Chrome vanadium steel
Page	302	302	302	302	302	302

ROGRIP pliers

Water pump pliers






	ROGRIP F 10" 1K	ROGRIP F 10" 2K	ROGRIP XL	Wapu type SP 7"	Wapu type SP 10"	Wapu type SP 12"
						
Working range:	Ø 60 mm (2")	Ø 60 mm (2")	Ø 102 mm (3.1/2")	Ø 34 mm (1")	Ø 43 mm (1.1/4")	Ø 48 mm (1.1/2")
Length:	254 mm (10")	254 mm (10")	440 mm (16")	175 mm (7")	250 mm (10")	300 mm (12")
Weight:	470 g	480 g	1.4 kg	150 g	290 g	460 g
Material:	Chrome vanadium steel	Chrome vanadium steel	Chrome vanadium steel	Chrome vanadium steel	Chrome vanadium steel	Chrome vanadium steel
Page	302	302	303	304	304	304

Water pump pliers






Corner pipe wrenches 45°

	Wapu type SPK 7"	Wapu type SPK 10"	Wapu type SPK 12"	Corner pipe wrench 45° Super S, 10"	Corner pipe wrench 45° Super S, 12"
					
Working range:	Ø 34 mm (1")	Ø 43 mm (1.1/4")	Ø 48 mm (1.1/2")	Ø 22 mm (1/2")	Ø 34 mm (1")
Length:	175 mm (7")	250 mm (10")	300 mm (12")	250 mm (10")	300 mm (12")
Weight:	165 g	315 g	475 g	400 g	810 g
Material:	Chrome vanadium steel	Chrome vanadium steel	Chrome vanadium steel	Chrome vanadium steel	Chrome vanadium steel
Page	305	305	305	307	307

Corner pipe wrenches 45°






	Corner pipe wrench 45° Super S, 16"	Corner pipe wrench 45° Super S, 20"	Corner pipe wrench 45° Super S, 24"	Corner pipe wrench 45°, 10"	Corner pipe wrench 45°, 12"
					
Working range:	Ø 48 mm (1.1/2")	Ø 60 mm (2")	Ø 89 mm (3")	Ø 22 mm (1/2")	Ø 34 mm (1")
Length:	420 mm (16")	540 mm (20")	640 mm (24")	250 mm (10")	300 mm (12")
Weight:	1.44 kg	2.44 kg	3.4 kg	370 g	740 g
Material:	Chrome vanadium steel	Chrome vanadium steel	Chrome vanadium steel	Chrome vanadium steel	Chrome vanadium steel
Page	307	307	307	307	307

Corner pipe wrenches 45°

	Corner pipe wrench 45°, 16"	Corner pipe wrench 45°, 20"	Pipe wrench 90° 12"	Pipe wrench 90° 16"	Pipe wrench 90° 20"
					
Working range:	Ø 48 mm (1.1/2")	Ø 60 mm (2")	Ø 34 mm (1")	Ø 48 mm (1.1/2")	Ø 60 mm (2")
Length:	420 mm (16")	540 mm (20")	300 mm (12")	420 mm (16")	540 mm (20")
Weight:	1.34 kg	2.4 kg	740 g	1.34 kg	2.4 kg
Material:	Chrome vanadium steel	Chrome vanadium steel	Chrome vanadium steel	Chrome vanadium steel	Chrome vanadium steel
Page	307	307	307	307	307

Pipe wrenches 90°

Pipe wrenches 90°

	Pipe wrench 90° 24"	Pipe wrench 90° 36"	HEAVY DUTY 6"	HEAVY DUTY 8"	HEAVY DUTY 10"
					
Working range:	Ø 89 mm (3")	Ø 114 mm (4")	Ø 22 mm (1/2")	Ø 32 mm (1")	Ø 48 mm (1.1/2")
Length:	640 mm (24")	750 mm (36")	152 mm (6")	200 mm (8")	250 mm (10")
Weight:	3.4 kg	5.6 kg	250 g	400 g	780 g
Material:	Chrome vanadium steel	Chrome vanadium steel	Chrome vanadium steel	Chrome vanadium steel	Chrome vanadium steel
Page	307	307	308	308	308

One-handed pipe wrenches HEAVY DUTY

General purpose tools

System overview

One-handed pipe wrench HEAVY DUTY

	HEAVY DUTY 12"	HEAVY DUTY 14"	HEAVY DUTY 18"	HEAVY DUTY 24"	HEAVY DUTY 36"
					
Working range:	Ø 60 mm (2")	Ø 60 mm (2")	Ø 73 mm (2.1/2")	Ø 89 mm (3")	Ø 141 mm (5")
Length:	300 mm (12")	350 mm (14")	450 mm (18")	600 mm (24")	900 mm (36")
Weight:	1.25 kg	1.68 kg	2.67 kg	4.32 kg	7.5 kg
Material:	Chrome vanadium steel	Chrome vanadium steel	Chrome vanadium steel	Chrome vanadium steel	Chrome vanadium steel
Page	308	308	308	308	308

One-handed pipe wrench HEAVY DUTY

One-handed pipe wrench ALUDUR

	HEAVY DUTY 48"	HEAVY DUTY 60"	ALUDUR 10"	ALUDUR 14"	ALUDUR 18"
					
Working range:	Ø 168 mm (6")	Ø 203 mm (8")	Ø 48 mm (1.1/2")	Ø 60 mm (2")	Ø 73 mm (2.1/2")
Length:	1,200 mm (48")	1,300 mm (60")	250 mm (10")	350 mm (14")	450 mm (18")
Weight:	15.8 kg	24 kg	480 g	990 g	1.63 kg
Material:	Chrome vanadium steel	Chrome vanadium steel	Aluminium	Aluminium	Aluminium
Page	308	308	308	308	308

One-handed pipe wrench ALUDUR

Pliers wrench

	ALUDUR 24"	ALUDUR 36"	ALUDUR 48"	ALUDUR 60"	ROFAST
					
Working range:	Ø 89 mm (3")	Ø 141 mm (5")	Ø 168 mm (6")	Ø 200 mm (8")	Ø 50 mm (1.7/8")
Length:	600 mm (24")	900 mm (36")	1,200 mm (48")	1,300 mm (60")	254 mm (10")
Weight:	2.51 kg	5 kg	8.42 kg	14.6 kg	580 g
Material:	Aluminium	Aluminium	Aluminium	Aluminium	Chrome vanadium steel
Page	308	308	308	308	310



One-handed pipe wrench STILLSON

	STILLSON 8"	STILLSON 10"	STILLSON 12"	STILLSON 14"	STILLSON 18"
					
Working range:	Ø 27 mm (3/4")	Ø 34 mm (1")	Ø 43 mm (1.1/4")	Ø 48 mm (1.1/2")	Ø 60 mm (2")
Length:	200 mm (8")	250 mm (10")	300 mm (12")	350 mm (14")	450 mm (18")
Weight:	280 g	590 g	715 g	1.04 kg	1.74 kg
Material:	Steel, drop forged	Steel, drop forged	Steel, drop forged	Steel, drop forged	Steel, drop forged
Page	308	308	308	308	308

One-handed pipe wrench STILLSON

	STILLSON 24"	STILLSON 36"
		
Working range:	Ø 73 mm (2.1/2")	Ø 102 mm (3.1/2")
Length:	600 mm (24")	900 mm (36")
Weight:	3.08 kg	5.69 kg
Material:	Steel, drop forged	Steel, drop forged
Page	308	308

ROCASE case system

	ROCASE	ROBOX
		
Sizes:	5	2
Volume:	5.7 until 48.2 l	0.65 until 1.37 l
Weight:	0.63 until 2.64 kg	0.09 until 0.17 kg
Material:	ABS plastic	ABS plastic
Page	335	336

Power tools

RO DD60	RO ID400	RO AG8000	RO RH4000	RO FL180
				
Voltage: 18 V	Voltage: 18 V	Voltage: 18 V	Voltage: 18 V	Max. lumin. flux: 410 lm
Max. torque soft: 34 Nm	Max. torque: 400 Nm	Grinding wheel Ø: 125 mm	Max. single blow energy (EPTA): 2.2 J	Max. operation time per battery load:
Max. torque hard: 60 Nm	Max. impact rate: 4,250 /min.	Idle frequency: 8,000 /min.	Max. impact rate: 4,000 /min.	18 V/2.0 Ah: 4.5 Std.
Drill-Ø steel: 13 mm	Bit retainer: Male square 1/2" (12.7 mm)		Drill-Ø concrete: 24 mm	18 V/4.0 Ah: 9.1 Std.
Drill-Ø soft wood: 38 mm	Speed/torque levels: 12		Bit retainer: SDS-plus	Weight: 0.46 kg
No-load speed: 0 - 450 / 0 - 1,600 /min				
321	324	325	327	328

General purpose tools

Pliers

ROGRIP M


Quickly adjustable water pump pliers

KEY FEATURES

- **Durable:** Due to double hardening, the teeth are particularly wear-resistant
- **Slip-resistant:** The shape of the teeth (self-locking), the 3-touch-point grip on the pipe and the soft-touch handle, prevent slipping of the pliers
- **Large gripping capacity:** 30% more gripping capacity*: 10" pliers up to 2" pipe diameters

TECHNICAL DATA

- **Chrome vanadium steel** tempered, drop forged with heavy-duty box joint
- **Polished head and joint**
- **Double hardened jaws**, extremely durable

Model	Working range		No.
ROGRIP M 7" 1K	1.1/4"	6	1000002697
ROGRIP M 7" 2K	1.1/4"	6	1000002698
ROGRIP M 10" 1K	2"	6	1000002699
ROGRIP M 10" 2K	2"	6	1000002700

Double hardened jaws extremely durable

Good grip on every surface even at highest demands

ROTHENBERGER Curve-Shape-Design

Especially suitable for larger pipe diameters. Reduces the danger of fingers getting clamped

Large gripping capacity

Reliable grip and hold up to 2" pipe diameter

New handle design

Good grip with two handle versions

Wide handles

More comfort and better power transmission



ROTHENBERGER Curve-Shape-Design – 7" pliers grip like 10" pliers!

ROGRIP F

Quickly adjustable water pump pliers


KEY FEATURES

- **Durable:** Due to double hardening, the teeth are particularly wear-resistant
- **Slip-resistant:** The shape of the teeth (self-locking), the 3-touch-point grip on the pipe and the soft-touch handle, prevent slipping of the pliers
- **Large gripping capacity:** 30% more gripping capacity*: 10" pliers up to 2" pipe diameters
- **Safety lock system:** prevents unintentional opening and enables a 50% quicker adjustment

Curve-Shape-Design: especially ergonomic

3-point grip over the middle for reliable clamping. Perfect grip on pipes up to Ø 2"



Model	Working range		No.
ROGRIP F 7" 1K	1.1/4"	6	1000002701
ROGRIP F 7" 2K	1.1/4"	6	1000002702
ROGRIP F 10" 1K	2"	6	1000002704
ROGRIP F 10" 2K	2"	6	1000002705

Double hardened jaws extremely durable

Good grip on every surface even at highest demands

ROTHENBERGER Curve-Shape-Design

Especially suitable for larger pipe diameters. Reduces the danger of fingers getting clamped

Large gripping capacity

Reliable grip and hold up to 2" pipe diameter

New handle design

Good grip with two handle versions

Wide handles

More comfort and better power transmission



Safety lock system

Prevents unintentional opening and enables a 50% quicker adjustment

ROTHENBERGER Curve-Shape-Design – 7" pliers grip like 10" pliers!

* than previous model

ROGRIP XL

Quickly adjustable water pump pliers

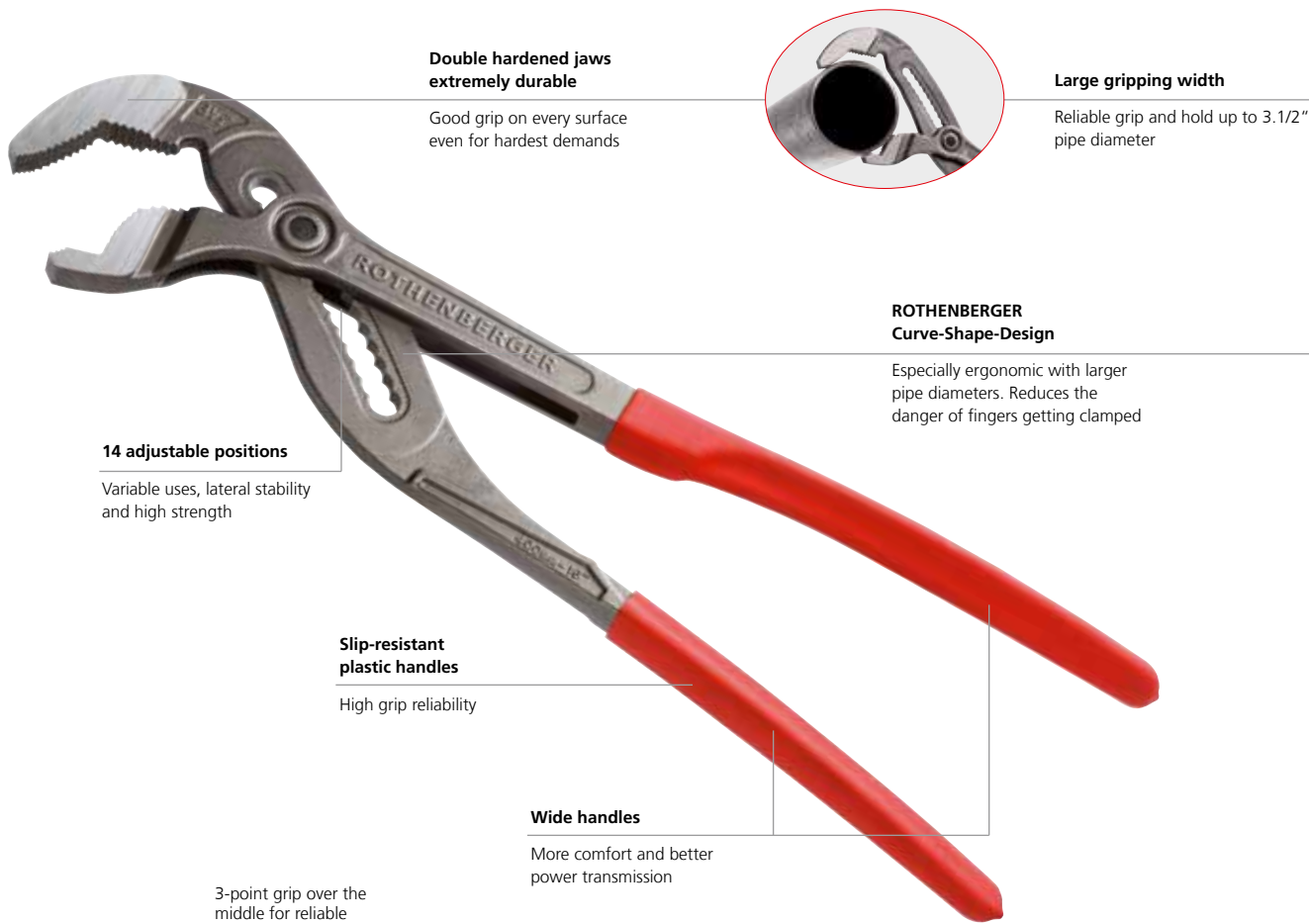
KEY FEATURES

- 16" pliers up to 3.1/2" pipe diameters
- 3-point grip: reliable clamping and perfect grip up to the maximal pipe diameter
- ROTHENBERGER Curve-Shape-Design: especially ergonomic by large pipe diameters. Reduces the danger of fingers getting clamped
- Wide handle for more comfort and better transmission of power
- 14 point size adjustment

TECHNICAL DATA

- **Chrome vanadium steel** tempered, drop forged with heavy-duty box joint
- **Polished head and joint**
- **Double hardened jaws**, extremely durable

Enormous gripping width of 3.1/2" – reliable grip during application



Double hardened jaws extremely durable

Good grip on every surface even for hardest demands



Large gripping width

Reliable grip and hold up to 3.1/2" pipe diameter

ROTHENBERGER Curve-Shape-Design

Especially ergonomic with larger pipe diameters. Reduces the danger of fingers getting clamped

14 adjustable positions

Variable uses, lateral stability and high strength

Slip-resistant plastic handles

High grip reliability

Wide handles

More comfort and better power transmission

3-point grip over the middle for reliable clamping. Perfect grip on pipes up to Ø 3.1/2"

Curve-Shape-Design: especially ergonomic



ROTHENBERGER Curve-Shape-Design – especially ergonomic!

inch	mm	max. inch	max. mm	g	No.
16"	440	3.1/2"	102	1,400	100000328

General purpose tools

Pliers

Water pump pliers SP

Complies with DIN 5231 D, with heavy-duty box joint, chrome vanadium steel, drop forged, tempered, polished head and joint



Product profile

KEY FEATURES

- Ideal for hard-to-reach places with the longer, thinner pliers head with measurements favourable for corners
- Optimum grip for reliable hold of pipes, flat objects, squared and hexagonal screws
- Long service life through induction hardened teeth
- Variable use: 7 size settings
- Non-slip even on smooth surfaces
- Safe use with the crush and pinch protection

TECHNICAL DATA

- Complies with DIN 5231 D
- Heavy-duty box-joint
- Abrasion-resistant surface protection with the epoxy-powder coating
- Chrome vanadium steel
- Drop forged, tempered
- Polished head and joint

Asymmetrical gripping surface

Optimum grip with the rhombus-shaped gripping surface

Measurements favourable for corners

Ideal for hard-to-reach places

Self-clamping jaws

Non-slip even on smooth pipes

Induction hardened teeth

Long service life and high wear resistance

Ergonomically shaped anti-slip legs

Reliable hold

7 size settings (10" and 12"), solid and durable

Variable use

Crush and clamp guard

Safe use

Optimum grip



No. 70527

No. 70528

No. 70529

inch	mm	max. inch	max. mm	g	No.
7"	175	1"	34	150	70527
10"	250	1.1/4"	43	290	70528
12"	300	1.1/2"	48	460	70529

Water pump pliers type SPK



KEY FEATURES

- Features similar to type SP, additionally with plastic covered handles

**Increased safety:
Plastic covered handles!**



L	L	⊙	⊙	⚖	📦	No.
inch	mm	max. inch	max. mm	g		
7"	175	1"	34	165	6	70521
10"	250	1.1/4"	43	315	6	70522
12"	300	1.1/2"	48	475	6	70523
10"	Counter display (12 pcs.)					070522D

Grooved water pump pliers CL



Chrome vanadium steel, chrome-plated, drop forged, tempered, polished head and sliding joint, even jaws, in compliance with DIN 5231 E

KEY FEATURES

- No slipping of the joint possible
- Absolutely firm fit in every open position
- Easy, smooth adjustment
- Induction hardened teeth for a long service life
- Crush and clamp guard prevent injuries
- Plastic covered handles



L	L	⊙	⊙	⚖	📦	No.
inch	mm	max. inch	max. mm	g		
9.1/2"	245	1.1/2"	48	330	1	70591
12"	300	2"	60	560	1	70592
16"	420	4"	114	1,150	1	70593

General purpose tools


Pliers sets


ROBOX pliers sets

3-part pliers sets for holding and turning of diverse types of pipes

3-part set (No. 1000002188) includes:
corner pipe wrench 45°, SUPER S, 1" (No. 070122X), ROGRIP M 10" 1K (No. 1000002699), ROGRIP M 7" 1K (1000002697), ROBOX B2650 (No. 1000002763)

3-part set (No. 1000002189) includes:
one-handed pipe wrench ALUDUR, 14" (No. 70160), ROGRIP M 10" (No. 100002699), ROGRIP M 7" 1K (1000002697), ROBOX B2650 (No. 1000002763)

For the individual pliers see  302 - 310

Model		No.
Pliers set w/ corner pipe wrench, ROBOX (3 pcs.)	1.6	1000002188*
Pliers set w/ ALUDUR, ROBOX (3 pcs.)	1.7	1000002189*

* ROBOX system p. 336

No. 1000002188



No. 1000002189




Professional sets

Practice-oriented set of pipe wrenches and pipe cutter

3-part set (No. 070130X) includes: pipe wrench 1" (No. 070122X), pipe wrench 1.1/2" (No. 070123X), pipe wrench 2" (No. 070124X)

4-part set (No. 070135X) includes: pipe wrench 1" (No. 070122X), pipe wrench 1.1/2" (No. 070123X), wapu SP 10" (No. 70528), TUBE CUTTER 35 (No. 70027)

3-part set (No. 070140X) includes: pipe wrench 1" (No. 070122X), pipe wrench 1.1/2" (No. 070123X), wapu SP 10" (No. 70528)

Model		No.
Set 1 - 1.1/2" - 2"	5.0	070130X
Set 2 - 1.1/2" + wapu SP 10" + TC35	3.1	070135X
Set 3 - 1.1/2" + wapu SP 10"	2.7	070140X



No. 070130X



No. 070135X




No. 070140X

ROGRIP pliers sets

The quickly adjustable water pump pliers generation ROGRIP is available as practice-oriented sets in two different sizes.

3-part set (No. 1000001068) includes:
ROGRIP M 7" 1K (No. 1000002697), ROGRIP M 10" 1K (No. 1000002699), ROGRIP XL 16" (No. 1000000328)

Model		No.
ROGRIP set M 7" 1K + M 10" 1K + ROGRIP XL		1000001068



No.1000001068

Corner pipe wrench 45°, SUPER S

Chrome vanadium steel, drop forged, tempered, with reinforced sleeve, polished jaws and a favourable size for corners

KEY FEATURES

- Self-clamping: 3-point clamping ensures reliable and firm grip even on smooth pipes
- Reliable grip and non-slip with teeth set against turning direction, induction hardened
- Double-T profile jaws, ideal for clamping different material forms, enables universal application



Inch	mm	L Inch	L mm	g	No.
1/2"	22	10"	250	400	6
1"	34	12"	300	810	
1.1/2"	48	16"	420	1,440	

Inch	mm	L Inch	L mm	g	No.
2"	60	20"	540	2,440	
3"	89	24"	640	3,400	1

Corner pipe wrench 45°

Chrome vanadium steel, drop forged, tempered, with reinforced sleeve, polished jaws and a favourable size for corners

KEY FEATURES

- Favourable size for corners
- Thin muzzle with thin jaws, 45° angled



Inch	mm	L Inch	L mm	g	No.
1/2"	22	10"	250	370	
1"	34	12"	300	740	

Inch	mm	L Inch	L mm	g	No.
1.1/2"	48	16"	420	1,340	
2"	60	20"	540	2,400	

Pipe wrench 90°

Chrome vanadium steel, drop forged, tempered, with reinforced sleeve, polished jaws and a favourable size for corners

KEY FEATURES

- Favourable size for corners
- Thin muzzle with thin jaws, 90° angled



Inch	mm	L Inch	L mm	g	No.
1"	34	12"	300	740	
1.1/2"	48	16"	420	1,340	
2"	60	20"	540	2,400	

Inch	mm	L Inch	L mm	g	No.
3"	89	24"	640	3,400	
4"	114	36"	750	5,600	

General purpose tools

Pliers

One-handed pipe wrench HEAVY DUTY



KEY FEATURES

- One-handed ratchet-like use, self-clamping, spring-supported hook
- Quick preset of pipe-Ø using scale on hook
- Wearing parts replaceable: hook and heel jaw can be purchased separately
- Monoblock cast body with high strength, double T profile, forged jaw and hook, fine polished, teeth set against turning direction, induction hardened, tempered and non-slip adjustment screw

US-norm GGG-W-651
type II class A



2-part set (No. 1000002194) includes: one-handed pipe wrench HEAVY DUTY 6" (No. 70148), ROBOX B2350 (No. 1500002641)

	L Inch	L mm	Ø Inch	Ø mm	kg		No. pliers	No. hook	No. jaws
	6"	160	3/4"	26	0.25	1	70148	70199	70189
	8"	200	1"	32	0.40	1	70150	70200	70190
	10"	250	1.1/2"	48	0.78	1	70151	70201	70191
	12"	300	2"	60	1.25	1	70152	70202	70192
	14"	350	2"	60	1.68	1	70153	70203	70193
	18"	450	2.1/2"	73	2.67	1	70154	70204	70194
	24"	600	3"	89	4.32	1	70155	70205	70195
	36"	900	5"	141	7.5	1	70156	70206	70196
	48"	1,200	6"	168	15.80	1	70157	70207	70197
	60"	1,300	8"	203	24.00	1	70158	70208	70198

Model	kg	No.
One-handed pipe wrench HEAVY DUTY 6", ROBOX 5	0.33	1000002194*

* ROBOX system p. 336

One-handed pipe wrench ALUDUR



KEY FEATURES

- Features similar to HEAVY DUTY
- **Weight savings of approx. 40%:** extremely light, high strength aluminium alloy
- Wearing parts replaceable: hook and heel jaw can be purchased separately

US-norm GGG-W-651
type I class B



	L Inch	L mm	Ø Inch	Ø mm	kg		No. pliers	No. hook	No. jaws
	10"	250	1.1/2"	48	0.48	1	70159	70201	70191
	14"	350	2"	60	0.99	1	70160	70203	70192
	18"	450	2.1/2"	73	1.63	1	70161	70204	70194
	24"	600	3"	89	2.51	1	70162	70205	70195
	36"	900	5"	141	5.00	1	70163	70206	70196
	48"	1,200	6"	168	8.42	1	70168	70207	70197
	60"	1,300	8"	203	14.60	1	70169	70208	70198

One-handed pipe wrench STILLSON



KEY FEATURES

- Features similar to HEAVY DUTY
- Hardened adjustment nut presses onto the handle during use and prevents undesired readjustment
- Optimised double-spring construction guarantees quick and firm self-clamping, ensuring secure hold even on smooth pipes

US-norm GGG-W-651
type I class B



	L Inch	L mm	Ø Inch	Ø mm	kg		No. pliers	No. hook
	8"	200	3/4"	27	0.28	1	70350	70374
	10"	250	1"	34	0.59	1	70351	70375
	12"	300	1.1/4"	43	0.72	1	70352	70376
	14"	350	1.1/2"	48	1.04	1	70353	70377
	18"	450	2"	60	1.74	1	70354	70378
	24"	600	2.1/2"	73	3.08	1	70355	70379
	36"	900	3.1/2"	102	5.69	1	70356	70380

One-handed pipe wrench OFFSET PATTERN HEAVY DUTY



KEY FEATURES

- Offset wrench head is ideal for working in confined spaces (e.g. near to the wall)
- One-handed ratchet-like use, self-clamping, spring-supported hook
- Quick preset of pipe Ø using scale on hook
- Wearing parts replaceable: hook and heel jaw can be purchased separately

							No. pliers	No. hook	No. jaws
	Inch	mm	Inch	mm	kg				
10"	250	1.1/2"	48	750	1		70166	70201	70191
14"	350	2"	60	1,460	1		70167	70203	70192



One-handed corner pipe wrench 90°



KEY FEATURES

- Features similar to **HEAVY DUTY**
- **Weight savings of approx. 40%:** extremely light, high strength aluminium alloy

						No. pliers	No. hook	No. jaws
	Inch	mm	Inch	mm	kg			
14"	350	2"	60	890		70115	70203	70192
18"	450	2.1/2"	73	1,490		70116	70204	70194



Chain pipe wrench 4" R/L



KEY FEATURES

- Profile handle made of drop forged chrome vanadium steel, polished head with hardened special tooth system, powerful chain made of tempered special steel
- Double-sided teeth surface set against the turning direction for use in both directions without re-inserting

						No.
max. Inch	max. mm	Inch	mm	g		
4"	115	12"	300	780	1	70235



Chain pipe wrench HEAVY DUTY

Very robust model for the toughest conditions, proven in pipeline construction, jaws and handle are forged, jaws are replaceable



KEY FEATURES

- Strong chain made of tempered special steel – fits every cross-section
- Double-sided tooth system for ratchet-like use, for right and left-handed operation

		jaws			No. pliers	No. jaws
max. Inch	max. mm	width mm	mm	kg		
1.1/2"	48	38	350	1.4	70242	70571
2.1/2"	73	52	690	3.5	70243	70572
4"	114	63	940	6.7	70244	70573
6"	168	78	1,120	12.6	70245	70574
8"	220	80	1,280	17.2	70246	70575
12"	324	84	1,630	24.2	70247	



Model		No.
	kg	
Spare chain HEAVY DUTY 2.1/2"	0.95	70263
Spare chain HEAVY DUTY 4"	1.40	70264
Spare chain HEAVY DUTY 6"	2.80	70265
Spare chain HEAVY DUTY 8"	3.40	70266
Spare chain HEAVY DUTY 12"	5.10	70267

General purpose tools

Pliers

Fittings wrench 90°

Special chrome vanadium steel, steel forged

KEY FEATURES

- Plastic jaws guarantee a secure and gentle grip especially for chrome-plated fittings and polished surfaces
- High-quality DURAMANT surface coating



Plastic jaws, gentle grip!



max. Inch	max. mm	L Inch	L mm	g		No.
1"	35	14"	356	740	1	70545
Plastic jaws				10		70548

Fitting key

Steel forged, burnished, smooth jaws for protection of fittings and delicate or polished surfaces



Model	L mm	Clamping width and depth mm			g	No.
Grid adjustment	260	75	45	690	350850	
Roll adjustment	275	65	45	780	350900	

ROFAST pliers wrench

For gripping, holding, clenching and bending of chrome-plated fittings with delicate surfaces

KEY FEATURES

- Gentle to surfaces: Smooth, parallel jaws enable use on delicate surfaces
- Versatile: Replaces spanner sets (0 - 50 mm or 0 - 1.7/8") and dispenses with use of other tools
- Convenient handling: Excellent pressing and clamping force with 10x force transfer for high gripping power



max. Inch	max. mm	L Inch	L mm	g	No.
1.7/8"	50	10"	254	580	150003170

SANIGRIP/SANIGRIP PL

Valve pliers PL

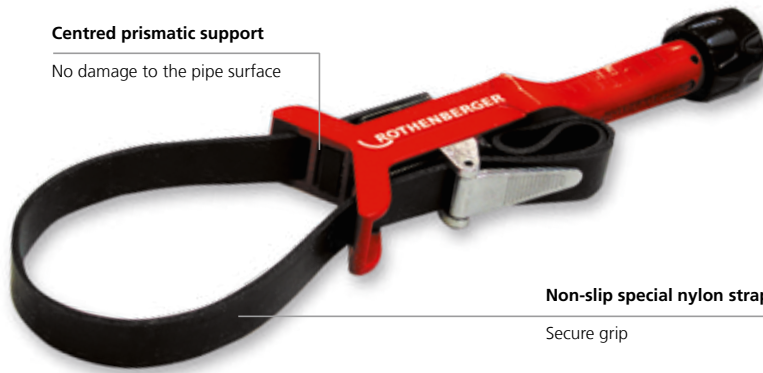
Special chrome vanadium steel, drop forged, chrome-plated, 4 adjustable sizes at joint, with toothed grip jaws. SANIGRIP PL designed with plastic jaws to protect fittings

KEY FEATURES

- Secure and gentle grip on valuable fittings without damaging polished surfaces
- Optimum grip is ideal for plastic screw joints up to Ø 62 mm (siphon)



Model	L Inch	L mm	max. mm	min. mm	g	No.
SANIGRIP	10"	250	80	14	270	70415
SANIGRIP PL	10"	250	62	14	280	70416



Non-slip special nylon strap

Secure grip

EASYGRIP




Automatic strap wrench for plastic pipes Ø 20 - 160 mm (3/4 - 6")

The indispensable tool for socket welding large diameter plastic pipes

KEY FEATURES

- No damage to pipe surface with the centred prismatic support
- Secure grip with special non-slip nylon strap



Model	 mm	 Inch	 kg	No.
EASYGRIP	20 - 160	6"	1.0	55075
Spare strap EASYGRIP			0.1	55076








Strap and fittings wrench

Made of aluminium special alloy, with replaceable nylon strap

KEY FEATURES

- Safe to use on chrome-plated fittings without damaging polished surfaces
- Use in the automotive industry (oil filter changes)

 Inch	 mm	 Inch	 mm	 g	No.
3"	89	12"	300	280	70240
Spare strap 3"				20	70268
8"	220	12"	300	290	70241
Spare strap 8"				30	70269



General purpose tools

Installation wrenches

UNI stepped key set

Radiator valve stepped key and ratchet set for installation and removal of heating valve nipples, tank connectors and short tap extensions. Chrome vanadium steel, hardened, nickelplated, square drive 1/2"

Product Profile

KEY FEATURES

- Universally applicable: cam, internal hexagonal and 12-edged driver, size 3/8 - 1/2 - 3/4 - 1" and other sizes in between
- No canting of nipples and screw connections with the special stepped key design
- Combination key allows installation and removal of heating nipples, tank connections and short tap extensions
- 1/2" ratchet makes installations quick and easy



No. 73298



No. 73280

1/2" ratchet

Fast and easy installation



No. 27180

Model	g		No.
Set: UNI stepped key and ratchet	670	10	73297
UNI stepped key	120		73298
Gas stepped key	80		73280
1/2" ratchet	440		27180



Sanitary four way key

Chrome vanadium special steel

KEY FEATURES

- Four external hexagonal 3/8", 1/2", 3/4", 1" up to 100 mm and installation / removal of heating valves and tank connectors
- Three inner threads M8, M10 and M12 for hanger bolts



Model	Dimensions mm	g	No.
Sanitary four way key multifunctional	220 x 220	610	351043

Sanitary four way key

Chrome vanadium special steel

KEY FEATURES

Multi-functional combined key:

- Four external hexagonal 3/8", 1/2", 3/4", 1" for short tap, extensions, installation and removal of heating valves and tank connectors
- Three inner threads M8, M10 and M12 for hanger bolts (wash basin fittings)



Model	Dimensions mm	g	No.
Sanitary four way key multifunctional	220 x 220	590	351044

RO-QUICK

Valve key

Release valve holder and key for eccentric and standard valves



KEY FEATURES

- Quick and problem-free use by the installation of bathtubs, basins and sinks
- Can be used from the bottom up
- With 2 facing, spring mounted locking cams, as well as holder with T-handle
- Adaptor with star handle for showers, bathtubs (optional accessory)
- Torque-proof immediately on insertion

No damage to chrome-plated parts!

Model	L mm	g	No.
RO-QUICK set			70439
RO-QUICK valve key	120	300	70414
Adaptor	75	70	70413

ROCLICK

Combined open-ended / hinged ratchet wrench

Chrome vanadium steel, polished and high shine chrome-plated

KEY FEATURES

- Moveable ring ratchet allows for use even in tight spaces
- Precise work with the fine-running ratchet (72 teeth)

Small operating radius of only 5°!



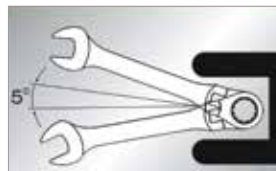
Fig. ROCLICK wrench set



7-part set (No. 70490) includes: ROCLICK combined spanner 8 - 10 - 11 - 13 - 14 - 17 - 19 mm, plastic case

Model	g		No.
ROCLICK spanner set, 7 pcs.	1,150	1	70490

Small 5° operating radius



Adjustable inclination angle



General purpose tools

Installation wrenches

Torque wrench set

For proper tightening of flange connections

Set with adjustable torque wrench (10-70 Nm) and 6 spanner inserts sizes 17, 22, 24, 26, 27 and 29 mm for flange connections on 1/4", 3/8", 1/2" and 5/8" pipe lines according to DIN EN 378-2:2012-08



Fix with torque urgently necessary!



Ø	Spanner width	Locking torque
1/4" / 6 mm	17 mm	14-18 Nm
3/8" / 10 mm	22 mm	33-42 Nm
1/2" / 12 mm	24 mm	50-62 Nm
1/2" / 12 mm	26 mm	50-62 Nm
5/8" / 15/16 mm	27 mm	63-77 Nm
5/8" / 15/16 mm	29 mm	63-77 Nm

7-part set (No. 1750.01) includes: spanner wrench sizes 17 - 22 - 24 - 26 - 27 - 29 mm, torque wrench, carrying bag

Model	kg	No.
Torque wrench set, 7 pcs.	3.5	175001

Ratchet spanner ROCLICK

Chrome vanadium, head black atramentized



KEY FEATURES

- With the spring mechanism – the harder the pressure, the more firmer the grip
- Self-ratcheting effect when turning back
- Fast extraction and loosening of screws
- Suitable especially for screws on pipes, cables and rods



Model	Key width mm	L mm	g	No.
Ratchet spanner ROCLICK	10	134	80	70420
Ratchet spanner ROCLICK	11	137	80	70419
Ratchet spanner ROCLICK	12	137	80	70421
Ratchet spanner ROCLICK	13	137	90	70422
Ratchet spanner ROCLICK	14	140	90	70423

Model	Key width mm	L mm	g	No.
Ratchet spanner ROCLICK	16	184	130	70424
Ratchet spanner ROCLICK	17	184	140	70425
Ratchet spanner ROCLICK	19	188	188	70426
Ratchet spanner ROCLICK	21	230	230	70427
Ratchet spanner ROCLICK	24	240	240	70418

SWO adjustable wrench

Chrome-vanadium steel, chrome-plated and polished finish



KEY FEATURES

- Metric measuring scale on jaws for easy jaws pre-setting and sizing of nuts, bolts, pipes, etc.
- Great accessibility in confined spaces, non-protruding jaw shank at maximum opening
- Absolutely parallel jaw surfaces ensure perfect grip of nuts and screws

Size	up to	Clamping width up to mm (Inch)	g	No.
6"	176 mm	34 (1.3/8")	205	1500001509
8"	216 mm	39 (1.1/2")	345	1500001510

General purpose tools

Installation wrenches



Basin nut wrench

Special chrome vanadium steel, drop forged, very tough

KEY FEATURES

- Optimum force transmission with the T-handle
- Rotatable claw for right and left-handed rotation



Clamping range mm	Clamping range Inch	L mm	g	No.
19 - 32	3/4" - 1.1/4"	235	475	1 70228

Telescopic basin nut wrench

Chrome-plated, with pivoted reversible jaw for right and left-handed rotation



**Telescopic attachment,
3 x adjustable in length!**

Clamping range mm	Clamping range Inch	L mm	g	No.
10 - 32	3/8 - 1.1/4"	275 - 455	710	70225
20 - 48	3/4 - 1.7/8"	290 - 470	740	70226
32 - 63	1.1/4 - 2.1/2"	290 - 470	780	70227

Basin nut pliers

Special chrome vanadium steel, drop forged, coated with adjustment screw



Model	L mm	g	No.
Basin nut pliers	270	580	351050

Basin nut wrench set 3/8"

The basin nut wrench set is used for loosening or tightening nuts at hard to access spots. The movable T-Grip enables a optimal use of force.



Model	g	No.
Set: Extension 200mm, T-Grip, Key-width 36-47 and bag	1000	100108
Set: Extension 200mm, T-Grip, Key-width 27-32-36 and bag	1050	100109
Set: Extension 200mm, T-Grip, Key-width 32-36-47 and bag	1200	100110

General purpose tools

Screwdrivers

EUROLINE

Screwdrivers

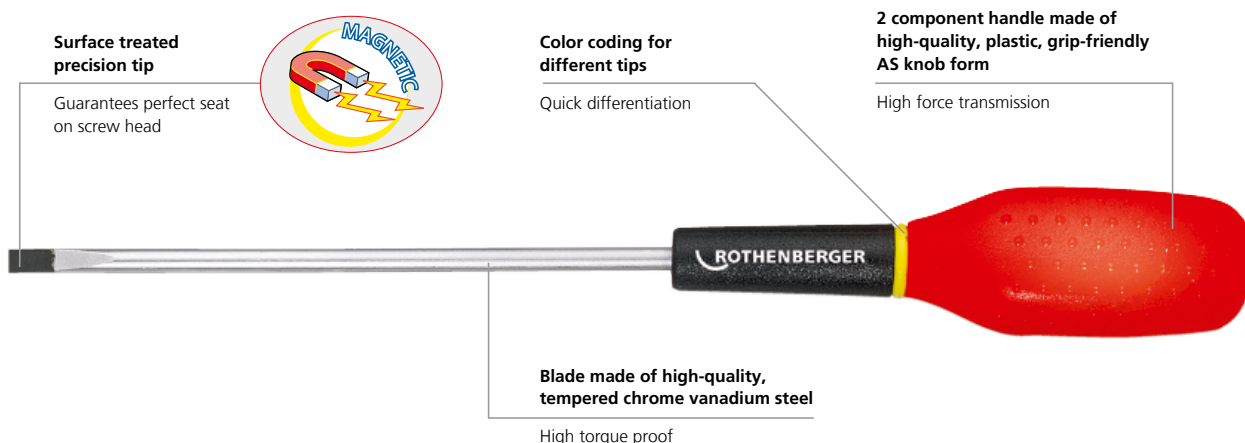
Product profile

KEY FEATURES

- High force transmission with 2 component handle
- High torque
- Guarantees perfect seat on screw head
- Color coding for different tips enables quick differentiation
- Oil, fat and hydrocarbon resistant

CHARACTERISTICS

- Blade made of chrome vanadium steel with high torque and hardness, matt chrome-plated
- Hardened, burnished tip with high durability for reliable force transmission even for tightly secured screws
- Guaranteed perfect seat on screw head, long service life even with long term use
- Handle made of high-quality plastic, grip-friendly AS knob form



Screwdrivers sets

Model	kg	No.
Screwdriver set Pozidriv	0.70	73571
Screwdriver set Phillips	0.70	73570

Sets include:

	Pozidriv No. 73571	Phillips No. 73570
	3.5 x 75 mm 4 x 100 mm	3.5 x 75 mm 4 x 100 mm
	5.5 x 125 mm 6.5 x 150 mm	5.5 x 125 mm 6.5 x 150 mm
	PZ 1 x 100 mm PZ 2 x 125 mm	
		PH 1 x 100 mm PH 2 x 125 mm

Chisel screwdriver set EUROLINE IMPAKT

Screwdriver with continuous, strengthened blade

Product profile

KEY FEATURES

- One-piece, strengthened blade with metal cap allows directed hammer blows, for example loosening stuck screws

Set (No. 73575) includes:

- 5.5 x 100 mm
- 6.5 x 125 mm
- 8 x 150 mm
- PH 1 x 80 mm
- PH 2 x 100 mm



2 tools in 1!

Color coding for different tips

Quick differentiation

Handle made of high-quality plastic, grip-friendly AS knob form

High force transmission



Surface treated precision tip

Guarantees perfect seat on screw head

Blade made of high-quality, tempered chrome vanadium steel

High torque proof

Constant strengthened blade with metal cap



5-part set (No. 73575) includes: slot screwdriver 55 x 100 (No. 73565), 6.5 x 125 (No. 73566), 8 x 150 (No. 73567), Phillips PH 1 x 80 mm 1 (No. 73536), PH 2 x 100 mm (No. 73537)

Model	g	No.
Chisel screwdriver set EUROLINE IMPAKT, 5 pcs.	950	73575

VDE screwdriver set

Blades made of chrome vanadium molybdenum steel, thoroughly hardened, extrusion-coated blade insulation tightly joined with handle, 1,000 Volt



Model	g	No.
VDE screwdriver set, includes: Slot 2,5 x 75; 4,0 x 100; 5,5 x 125; 6,5 x 150 Phillips PH 1 x 80; PH 2 x 100 and live-wire-tester	680	323126

General purpose tools

Installation aids

ROCHECK

Spirit level for angled valves

For exact vertical and horizontal alignment of fittings

KEY FEATURES

- With horizontal and head levels
- One side with 1/2" external screw thread

Precise Installation!



ROCHECK

Spirit level for standard distances

Accurate installations with installation gauge for fittings, with horizontal and vertical levels, unbreakable

KEY FEATURES

- For standard distances: 97 - 120 - 153 - 160 - 170 - 200 - 210 mm

Exact Adjustment!

Exact installation by assembling jig for braces



4-part set (No. 70667) includes: spirit level for angled valves 200 mm (No. 70661), spirit level for standard distances 300 mm (No. 70665), 1 flexible ruler 2 m (No. 252100), steel carrying case (No. 24022)

Model	g	No.
ROCHECK set in steel case	2,260	70667
ROCHECK spirit level for angled valves 200 mm	220	70661
ROCHECK spirit level for standard distances 300 mm	260	70665

Cartridge extractor set

Simple extraction of cartridges in taps



KEY FEATURES

- Simple extraction of cartridges in taps
- 4 adaptors with hook, threaded rod, screw or rivet adaptor for cartridges made before 1979, starting in 1979 and MOEM cartridges, as well as extraction tools

Simple use:

Screw the appropriate cartridge extractor on the threaded rod, attach to the cartridge, guide the cartridge body and counter piece over the thread rod, rotate the t-handle and pull the cartridge out of its seat.

Set (No. 854390) includes: T-handle (No. 854380), screw 12 x 92 (No. 854381), turning handle (No. 854382), threaded rod M10 x 130 (No. 854383), cartridge body 32 x 131 (No. 854384), cartridge extractor with thread (No. 854385), cartridge extractor with hook (No. 854386), cartridge extractor 20 x 45 (No. 854387), counter piece (No. 854388), steel carrying case

Model	g	No.
9-part set	1,250	854390

Standard spirit level



KEY FEATURES

- Deformation-free aluminium rectangular profile, anodised
- Imprinted, centred centimetre scale
- Shock and weather proof
- Horizontal and vertical levels, non-breakable, permanently aligned in carrier
- Measuring accuracy in normal position $0.029^\circ = 0.5 \text{ mm / m}$

Model	L mm	g	No.
Standard spirit level	430	260	1500001583
Standard spirit level	600	340	1500001547
Standard spirit level	1,000	640	1500001548

ROMATIC and ruler

Measuring tape



KEY FEATURES

- Easy handling
- Automatic tape rewind
- With set/stop button that can be used as marker for repeated measurements



Model	Measuring length m	Tape width mm	g	No.
Tape measure ROMATIC	5	19	230	77397
Folding ruler, wooden	2		100	252100

Sheet metal crimping pliers

Self-opening, PVC coated handles



KEY FEATURES

- For joining of sheets up to 1 mm thick using ripple on pipe end
- Exact and quick adjustment

L Zoll	L mm	Sheet thickness mm	g	No.
10"	250	1.0	450	71095

General purpose tools

Installation aids

Electrical power combination pliers

- Equipped with an integrated ring spanner for M8 and M10 nuts/screws
- Inductive hardened blade to ensure a higher service life
- Asymmetric grip function can be used to grab round or flat materials



1000 V
IEC 60900

L mm	g	No.
180	250	1500003163

Electrical edge cutter Electrical power edge cutter

- Inductive hardened blade to ensure a higher service life
- Wave profile of the blade provides an anti-slip function: The wire does not slip out while being cut
- Comfortable handling thanks to ergonomic 3K handles



1000 V
IEC 60900

L mm	g	No.
160	210	1500003164
200	300	1500003166

Electrical multi insulation stripper

- Improvement of the common insulation stripper and does not need an adjusting screw
- Ideally suitable to strip \varnothing 5 – 16 mm cable coatings
- The stripping function enables cable stripping of single- or multicore cables up to \varnothing 5.0 mm



1000 V
IEC 60900

L mm	g	No.
180	230	1500003167

Voltage Detector E-Detector 90–1000 V

The non-contact voltage tester detects AC voltage in a range of 90–1000 V. When voltage is detected, a red LED lights up. In addition, a flashlight is attached to the voltage tester.



Model	g	No.
Voltage Detector E-Detector 90–1000 V	90	1500003374

Electrical long nose pliers

- Inductive hardened blade to ensure a higher service life
- Integrated M10 ring spanner to tighten/loosen nuts and screws
- Grab wires precisely, the serrated gripping surface ensures a tight, firm grip



1000 V
IEC 60900

L mm	g	No.
200	200	1500003168

Ergonomic electrical installation pliers

- Integrated stripping function, ring spanner and gripping zone for flat and round material
- Multi purpose tool makes lots of other tools obsolete
- Angled design enables low-fatigue working



1000 V
IEC 60900

L mm	g	No.
200	290	1500003169

RO DD60 cordless drill driver

The RO DD60 can be used as drill and screwdriver



KEY FEATURES

- Quick change of bit retainer and bits, for flexible working
- Spindle with hexagonal recess for screwdriver bits for working without chuck
- Precise working conditions thanks to integrated working light for illuminating the contact area
- Handy belt hook and bit holder can be fixed either on the right or left side

TECHNICAL DATA

Batteryvoltage:	18 V
Max. torque:	34 Nm / 60 Nm
Weight with battery pack:	1.9 kg
Drill-Ø steel:	13 mm
Drill-Ø soft wood:	38 mm



Set (No.1000001647) includes: RO DD60 drill driver, RO BP18/2 2.0 Ah battery (No. 1000001652), RO BC14/36 charger EU (No. 1000001654), quick change chuck, quick change bit holder, belt hook and bit case, ROCASE 4414 anthracite (No. 1000001949)

Model	No.
RO DD60 drill driver w/o battery and charger	1000002035
RO DD60 drill driver set EU	1000001647

¹⁾ Complete terms and conditions at rothenberger.com/roservice
RO SERVICE+ only valid in participating countries
²⁾ More information at cordless-alliance-system.com

General purpose tools

Screw bits and drill bits

ROBIT PRO

32 pieces



Set (No. 1500002453) includes: 30-bit: 1/4" x 25 mm, PH: 1, 2, 2, 3 mm, PZ: 1, 2, 2, 3 mm, FD: 3, 4, 5, 6 mm, HW: 3, 4, 5, 6 mm, TX: 10, 15, 20, 25, 27, 30, 40 mm, TTX: 10, 15, 20, 25, 27, 30, 40 mm, quick release magnetic bit holder

KEY FEATURES

- Extensive bit set as perfect equipment for professional craftsmen
- High-quality material for heavy usage
- Adjustable belt-clip

Model	No.
ROBIT PRO 32 pcs.	1500002453

ROBIT PRO torsion

15 pieces



Set (No. 1500002454) includes: 14-bit: 1/4" x 25 mm, PH: 1, 2 mm, PZ: 1, 2 mm, FD: 4, 6 mm, HEX: 3, 4, 5 mm, TX: 10, 15, 20, 25, 30 mm, quick release magnetic bit holder

KEY FEATURES

- For extrem usage
- Suitable for an impact wrench
- Special alloy for maximum life time

Model	No.
ROBIT PRO torsion bit set 15 pcs.	1500002454

Toolkit sets

For versatile applications in installation and maintenance



Set (No. 1000002180) includes: 1x thin type lever ratchet handle with 72-teeth gear, 2x extension bars 50mm and 100mm, 1x universal joint, 1x sliding T-head 3/8" x 1/4", 12x sockets: 4-5-5,5-6-7-8-9-10-11-12-13-14mm, in soft foam and ROBOX B2350 (No. 1500002641)

Set (No. 1000002181) includes: 1x 1-1/4" bit holder, 52x bits 1/4" x 25 mm: 13x star bit (torx) 5-6-7-8-9-10-15-20-25-27-30-35-40 mm, 6x hex bit (H) 2-2,5-3-4-5-6 mm, 3x tri wing bit 1-2-3 mm, 5-ribe bit (RM) 5-6-7-8-9 mm, 9-pentalobe bit 7-10-15-20-25-27-30-40-45 mm, 3-spline bit (M) 5-6-8 mm, 6-hex bit SAE (H) 5/64", 3/32", 7/64", 1/8", 9/64", 5/32", 4x torq bit 4-6-8-10 mm, 4x spanner bit 4-6-8-10 mm, in soft foam and ROBOX B2350 (No. 1000002641)

Set (No. 1000002182) includes: 10x bits 90mm: 2x Phillips: 1-2 mm, 2x Pozzi: 1-2 mm, 6x torx: 10-15-20-25-30-40 mm with color ring in soft foam and ROBOX B2350 (No. 1500002641)

Model	No.
17 pcs. socket set 1/4", ROBOX	1000002180*
53 pcs. special application bit set 1/4", ROBOX	1000002181*
10 pcs. color ring bit set 1/4", ROBOX	1000002182*

* ROBOX system p. 336



UNICUT HM

Carbide-tipped hole saws for cutting circular holes
 Ø 16 - 140 mm (5/8 - 5.1/2") without impact

Product profile

APPLICATION AREA

For stationary and free-hand cutting of circular holes. For iron, steel, V2A - V4A, cast, copper, bronze, aluminium, zinc, plastic, fibre-glass, chipboard and wood, light construction plaster boards without impact

KEY FEATURES

- For use even in high-speed hand drills and stand-mounted drilling machines due to anti-slip shaft
- Positive cutting angle for good chip removal
- Includes adaptor holder and replaceable HSS-Co5 centring drill up to 4 mm sheet thickness, cutting depth 10 mm



UNICUT HM

Hole saw set



(Fig. similar)



(Fig. similar)

mm	Inch	g	No.	mm	Inch	g	No.
16	5/8"	100	21316	34		180	21334
29		140	21329	35	1.3/8"	190	21335

Set (No. 21300) includes: hard metal hole saws, drill paste 40 g and spare centering pin Ø 6 mm (No. 21394), in plastic case

Model	g	No.
UNICUT HM Set 22 - 25 - 28 - 32 - 35 mm	950	21300
Spare centering pin HSS 8 mm		21395

General purpose tools

Impact wrench

RO ID400 cordless impact wrench

Enables the quick assembly and disassembly of screws and hexagon nuts. The profiles of pre-wall installations and sprinkler systems therefore no longer pose a challenge.



KEY FEATURES

- Unique brushless motor for quick work progress and highest efficiency for any application
- High torque accompanied by an exceptionally compact design
- Twelve speed/torque levels for a wide range of applications
- Handy belt hook, can be fixed either on the right or left side

TECHNICAL DATA

Battery voltage:	18 V
Weight with Batterypack:	1.9 kg
Max. torque:	400 Nm
Max. no-load speed:	0 - 2,150 rpm
Maximum impact rate:	4,250 rpm

High torque

Accompanied by an exceptionally compact design

Belt hook

Can be fixed either on the right or left side

Twelve speed / torque levels

For a wide range of applications

Maximum power

Intelligent battery management with charge indicator to control the status of charge

Unique brushless motor

For quick work progress and highest efficiency for any application

Bit holder

Can be fixed either on the right or left side



No. 100001949

Set (No.100001648) includes: RO ID400 impact wrench, RO BP18/2 2.0 Ah battery (No. 1000001652), RO BC14/36 charger EU (No. 1000001654), bit holder, belt hook, RO CASE 4414 anthracite (No. 1000001949)

Model	No.
RO ID400 impact wrench w/o battery and charger	1000002036
RO ID400 impact wrench set EU	1000001648

¹⁾ Complete terms and conditions at rothenberger.com/roservice
RO SERVICE+ only valid in participating countries
²⁾ More information at cordless-alliance-system.com



RO AG8000 cordless angle grinder

Smaller working steps such as the abrasive removal of hanger bolts or the cutting of a U-profile are handled quickly and easily. The slim design, as well as the rotating battery, enables work to be undertaken in cramped spaces and also simplifies working areas such as the disassembly area.

KEY FEATURES

- Slim design for prolonged comfort when working overhead or in areas with limited space
- Save time and be safe with the tool-free adjustable guard
- Detachable dust protection filter protects motor from coarse particles

TECHNICAL DATA

Battery voltage:	18 V
Weight without	
Batterypack:	1.7 kg
Idle frequency:	8,000 / min ⁻¹
Grinding wheel Ø:	125 mm
Spindle thread:	M14



Set (No. 1000001649) includes: RO AG8000 angle grinder, RO BP18/4 4.0 Ah battery (No. 1000001653), RO BC14/36 charger EU (No. 1000001654), guard, quick-locking nut, side handle, dust filter, RO CASE 4414 anthracite (No. 1000001947)

Model	No.
RO AG8000 angle grinder w/o battery + charger	1000002037
RO AG8000 angle grinder set EU	1000001649



No. 1300003338

¹⁾ Complete terms and conditions at rothenberger.com/roservice
RO SERVICE+ only valid in participating countries

²⁾ More information at cordless-alliance-system.com

General purpose tools

Cutting discs

Cutting disc assortment

For burr-free and quick cutting of stainless steel, steel, cast iron and stone

Description	No.	Alloyed and unalloyed steel	High strength steel	Tool steel	Rust- and acid-resistant steel	Edged steel profiles	Steel panel	Welded joints	Edged stainless steel profiles	Cast	Aluminium alloying	Copper	Brass / bronze
Cutting disc INOX PROFI PLUS (115 x 1 x 22)	071533D	●	●	●	●	●	●	●	●	○	●	●	●
Cutting disc INOX PROFI PLUS (125 x 1 x 22)	071534D	●	●	●	●	●	●	●	●	○	●	●	●
Cutting disc INOX FINE CUT (115 x 0.8 x 22)	1500003464	●	●	●	●	●	●	●	●	○	●	●	●
Cutting disc INOX FINE CUT (125 x 0.8 x 22)	1500003465	●	●	●	●	●	●	●	●	○	●	●	●

●● = very well suited ● = well suited ○ = partially suited

INOX PROFI PLUS

Grinding / cutting discs for stainless steel (1 mm)

For thin sheet metal (e.g. in body work, tank equipment and container construction), steel cable, thin-walled profiles and pipes made of stainless steel and NE metals, composite materials (GFK), high-temperature materials

- This very thin wheel enables a one-of-a-kind clean cut with a minimum of effort in a short amount of time
- Millimetre accurate use, vibration-free operation without thermal blue discolouration or burr formation (burr-free)



Model	Dimensions mm	g	No.
PROFI PLUS box 115 (10 pcs.)	115 x 1 x 22	350	1 071533D
PROFI PLUS box 125 (10 pcs.)	125 x 1 x 22	450	1 071534D



Follow all manufacturers instructions



Don't rough down



Follow work safety measures



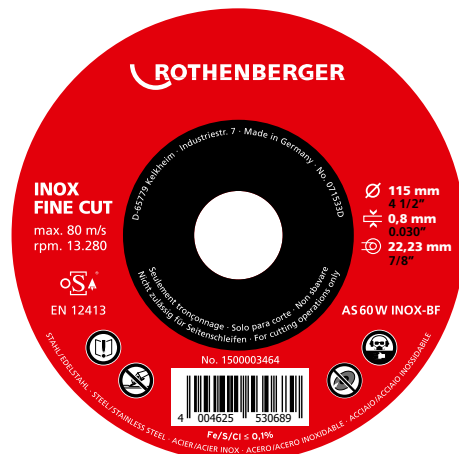
Do not use defective grinding/cutting discs

INOX-FINE CUT

Cutting disc for stainless steel (0.8 mm)

For thin sheets, steel cables, thin-walled profiles and stainless steel tubes and non-ferrous metals, composite materials (GFK).

- Very high cutting speed ensures a soft and fast cut with minimum contact pressure
- Low flying sparks with extra fine and low-burr cutting pattern



Model	Dimensions mm	g	No.
INOX FINE CUT (10 pcs.)	115 x 0,8 x 22	333	1500003464
INOX FINE CUT (10 pcs.)	125 x 0,8 x 22	390	1500003465

General purpose tools

Rotary hammer and chisel



RO RH4000 cordless rotary hammer

The notion of compatibility improves the craftsmanship of the professional plumbers. With the help of the new cordless rotary hammer, slots can easily be drawn, tiling can be knocked into place and pipe clamps can be fastened. There are no working hindrances due to empty batteries, thanks to the ROTHENBERGER battery platform.

KEY FEATURES

- Combination hammer with 3 functions: hammer drilling, drilling and chiselling
- Variospeed (V) electronics for working at customised speeds to suit various application materials
- S-automatic safety clutch: mechanical decoupling of the drive for safe working should the drill stop unexpectedly
- LED work light for optimum view of the drilling site
- Battery packs with capacity display for checking the charge status

TECHNICAL DATA

Battery voltage:	18 V
Weight with battery pack:	2.9 kg
Max. single blow energy (EPTA):	2.2 J
Maximum impact rate:	4,000 /min.
Drill-Ø concrete with hammer drills:	24 mm
Drill-Ø masonry with core bits:	68 mm
Drill-Ø steel:	13 mm
Drill-Ø soft wood:	25 mm
No-load speed:	0 - 1,100 /min.
Bit retainer:	SDS-plus

Automatic safety clutch

Mechanical decoupling of the drive for safe working, in case the drill driver stops unexpectedly



No. 1000001949

SDS-plus

Bit retainer

Variospeed (V) electronics

For working at customised speeds to suit various application materials

LED light

Integrated working light to illuminate the contact area

Maximum power

Intelligent battery management with charge indicator to control the status of charge

Set (No. 1000001650) includes: RO RH4000 rotary hammer (No. 1000002038), RO BP18/4 4.0 Ah battery (No. 1000001653), RO BC14/36 charger EU (No. 1000001654), hammer chuck for tools with SDS-plus shank end, rubber-coated side handle drilling depth guide, ROCASE 4414 anthracite (No. 1000001948)

Model	No.
RO RH4000 rotary hammer w/o battery + charger	1000002038
RO RH4000 rotary hammer set EU	1000001650

Chisel

High-quality, fully coated steel chisels with high life time. The construction and cutting edge geometry enable a heavy stock removal

Set (No. 1500002829) includes: flat chisel SDS-plus (No. 1500002825), sharp chisel SDS-plus (No. 1500002826), tile chisel SDS-plus, 40 mm (No. 1500002828), ROBOX B2650 (No. 1000002763)



No. 1500002828

No. 1500002827

No. 1500002826

No. 1500002825

No. 1500002824

Model	Length	No.
Tile chisel 80 mm SDS-plus 170 mm	170 mm	1500002824
Flat chisel SDS-plus 250 mm	250 mm	1500002825
Sharp chisel SDS-plus 250 mm	250 mm	1500002826
Hollow chisel 22 mm SDS-plus 250 mm	250 mm	1500002827
Tile chisel 40 mm SDS-plus 250 mm	250 mm	1500002828
Chisel set, 3 pcs. SDS-plus w/ ROBOX*		1500002829

¹⁾ Complete terms and conditions at rothenberger.com/roservice
RO SERVICE+ only valid in participating countries

²⁾ More information at cordless-alliance-system.com

General purpose tools

Drill bits and lamp

SDS-plus hammer drill



Model	Ø	No.
Hammer drill SDS-plus	6 x 110 mm	111405
Hammer drill SDS-plus	8 x 110 mm	111411
Hammer drill SDS-plus	10 x 160 mm	111419
Hammer drill SDS-plus	12 x 160 mm	111424



Model	Ø	No.
Hammer drill SDS-plus	18 x 450/410 mm	111447
Hammer drill SDS-plus	22 x 450 mm	111452
Hammer drill SDS-plus	25 x 450 mm	111455

RO FL180 cordless LED lamp

The RO FL180 is the perfect companion for plumbing technicians and heating engineers. Due to its size and various adjustment functions, the RO FL180 emits the perfect amount of light and facilitates the everyday work of professional tradesmen.



KEY FEATURES:

- Powerful LED inspection lamp for uniform, bright illumination of the working area
- Compact and handy for versatile use
- Lamp head can be turned and swivelled through 180° providing almost infinite positions for the lamp
- Swivelling hook for suspending the lamp

TECHNICAL DATA

Max. lumin. flux:	440 lm
Max. operation time per battery charge:	18 V / 2.0 Ah: 4.5h / 18 V / 4.0 Ah: 9.1h
Weight without Battery pack:	0.46 kg



Set (No. 1000001651) includes: RO FL180 LED lamp, RO BP18/2 2.0 Ah battery (No. 1000001652), RO BC14/36 charger EU (No. 1000001654), RO CASE 4212 anthracite

Model	No.
RO FL180 LED lamp w/o battery and charger	1000001734
RO FL180 LED lamp set EU	1000001651





CAS battery packs and charger

Unlimited combinations: Now you can combine machines, battery packs and chargers of different manufacturer with each other without any problems. CAS uses the world's most powerful battery pack system in the industry - from Metabo.

With more than 30 years of battery pack expertise, Metabo is pioneer in the battery pack technology and in the topic of "cordless construction site".

In comparison to the Li-Ion 4.0 Ah, the Li-HD 4.0 Ah is having less weight, a slimmer design, but still the same capacity.

Intelligent battery management

Permanent Electronic Single Cell Protection (ESCP) when charging, for particularly long life



No. 100001652



No. 1000001653



No. 1000002549



No. 1000002548

High robustness due to outer rubber

Capacity control for a permanent control of the filling level

66% faster charging

In comparison to the battery charger of the ROMAX 3000



100% compatibility for over 180 machines in the 18 V class!



Model	No.
RO BP18/2, 2.0 Ah 18 V Li-Power battery	1000001652
RO BP18/4, 4.0 Ah 18 V Li-Power battery	1000001653
RO BP18/4, 4.0 Ah 18 V Li-HD battery	1000002548
RO BP18/8, 8.0 Ah 18 V Li-HD battery	1000002549
RO BC 14/36 battery charger, 230 V, EU	1000001654

¹⁾ Complete terms and conditions at rothenberger.com/roservice

RO SERVICE+ only valid in participating countries

²⁾ More information at cordless-alliance-system.com

General purpose tools



Hammers and chisels

Fitter's hammer

Complies with **DIN 1041**, hickory wooden handle, head secured by sealed shaft

DIN
-Norm



Head weight 	Total weight 	No.
300	470	322823

Lump hammer

Complies with **DIN 6475**, hickory wooden handle, head secured by sealed shaft

DIN
-Norm



Head weight 	Total weight 	No.
1,250	1,380	322922

Chisel



Safety tempered impact head prevents splintering off the chisel head

- Silver lacquered tip
- Chrome-manganese-silicon-steel



No. 77050

14

Model	Length mm	Shaft mm	Cutting width mm	without hand protection 	with hand protection 	No.
Mason chisel, flat	300	16	22	470	560	77050

Parallel vice

With forged and hardened pipe jaws, steel forged underneath the parallel vice jaws

- Non-breakable
- Protected, powerful spindle with trapezoidal thread
- Re-adjustable double-sided guide
- Anvil base for levelling and compressing work



Jaw width mm	Clamping width mm	depth mm	for pipes Inch	for pipes mm	kg	No.
120	125	65	3/8 - 1.1/2"	16 - 55	8.7	070705X
140	150	80	3/4 - 2"	27 - 70	15.6	070735X

Pipe vice

Foldable, with automatic closing hook, upper jaw and lower support jaw milled and hardened. Powerful smooth-running spindle. Durable epoxy-powder coated

- Reliable hold: Pipe support and movable upper jaw



For pipes / inch	for pipes / mm	kg	No.
1/8 - 2"	10 - 60	3.7	70710
Spare jaws (contains: 3 pcs.)		0.2	70670
1/8 - 3"	10 - 89	7.9	70712
Spare jaws (contains: 3 pcs.)		0.2	70672
1/8 - 4"	10 - 114	11.7	70711
Spare jaws (contains: 3 pcs.)		0.2	70671

Chain pipe vice

Tough, powerful design with V-shaped support, bending device, pipe support, wear-resistant jaws are forged and hardened, powerful chain, quick fastening due to offset lever and pre-tensioning screw, simple conversion to other pipe diameters, extremely robust powder epoxy coating

- V-shaped pipe supports with teeth and bridge prevent undesired bending during clamping
- Exchangeable jaws



For pipes / Inch	for pipes / mm	kg	No.
1/8 - 2.1/2"	10 - 76	3.8	70713
Spare jaw		0.7	70734
Spare chain		0.5	70731
1/8 - 4"	10 - 114	6.2	70714
Spare jaw		0.8	70721
Spare chain		0.6	70732
1/8 - 6"	10 - 165	9.3	70715
Spare jaw		0.9	70722
Spare chain		1.3	70733

ROBOY clamping workbench

For on-site repair and service work

- Portable, handy and practical workbench with the smallest dimensions
- Mountable on door frames or walls: Prevents floor damage and saves space
- Pressure plate is coated with rubber to protect against damage
- Spindle with trapezoidal thread for quick adjustment
- With height-adjustable support pipe for additional stability



Parallel vice (No. 070705X) and rotatable table not included

Model	Dimensions / mm	kg	No.
ROBOY	650 x 400	14.9	70700

General purpose tools

Workbenches

Tripod uni workbench

With / without integrated chain vice

- Collapsible, extremely stable frame
- Attachment of various tools is possible
- Screw fixture for 1" pipe to enable overhead support of the unit
- **with integrated chain vice**
- Bending of pipes Ø 3/8" - 1/2" - 7/8"
- **without integrated chain vice**
- Bending of pipes Ø 3/8" - 1/2" - 3/4"
- Universal vice attachments applicable for pipe vice (No. 70710) and chain pipe vices (No. 70713, 70714, 70715)



No. 70752



No. 70740



No. 70751

Working unit

With pipe vice 1/8" - 2"

- Collapsible, stable, non-slip frame
- with folding pipe vice, bending holes and large tool tray

Model	kg	No.
Tripod universal workbench w/ chain vice	16.0	70752
Tripod universal workbench w/o chain vice	15.3	70751
Tool 1/8" - 2"	21.0	70740

Telescopic workbench

- Stable, collapsible steel tube frame with the smallest dimensions
- Portable, handy and practical
- With tough beech wood plate for an optimal work surface
- Steel edges all around: ideal for vice machining
- Individually removable supporting legs for working steps with ease



Model	Size mm	kg	No.
Telescopic workbench	700 x 450 x 30	17.4	070699X

Universal workbench

- Stable and tough, easy to transport: collapsible tubular frame
- Optimum work surface: work plate made of processed beech wood
- Model "Pipe-fitter" steel edges all around: ideal for vice machining



Model	Size mm	kg	No.
Installer	1,200 x 550 x 835	30	070690X
Pipe-fitter	1,000 x 700 x 835	32	70696
Pipe-fitter	1,200 x 750 x 835	38	70698

Hemp dispenser with roll



Model	No.
Roll 40 g / 40 m	70623

All-purpose marker

Writes on tile and glass



Carpenter pencil



Model	No.
All-purpose marker	856911
Carpenter pencil	856907

Cutter knife



Model	No.
Cutter knife w/ 4 blades, 18 mm	1500000087
Blades for cutter knife (10 pcs.)	1500001299

Trendy tool bag

- Lots of storage room for all your tools



Volume:
ca. 42 l

Tool bag

- Offers a lot of pockets and tool holders with a waterproof plastic bottom



Volume:
ca. 30 l

Tool bag, small

- Offers a lot of pockets and tool holders with a waterproof plastic bottom



Volume:
ca. 15 l

Model	No.
Trendy tool bag (380 x 300 x 370 mm)	402311
Tool bag (450 x 285 x 335 mm)	1500001320

Model	No.
Tool bag, small (280 x 360 x 230 mm)	1500002182

Toolbox apprentice

- Lots of storage room for all your tools



Model	No.
Toolbox apprentice	402312

Trendy shoulder toolbox

- Very light, handy bag for the most important tools



Volume:
ca. 11 l

Tool bag universal

- Ideal for hand tools with straps and flaps inside the roll cover



Model	No.
Trendy shoulder toolbox (250 x 220 x 140 mm)	402308
Tool bag universal (220 x 440 x 230 mm)	1500002230

General purpose tools

Tool bags

Apprentice set, 50 pcs.

Tough installation toolbox completely equipped with all the tools the craftsman needs

- Extensive and practical tool assortment
- Case made of galvanized steel
- Dimension: 530 x 200 x 200 mm



Set (No. 19166) includes: water pump wrench type SP 10", corner pipe wrench Super S (1"), ALU-spirit level, anodized (500 mm), hacksaw frame (300 mm), 10x HSE 4 PLUS saw blades, fitter's hammer (300 g), lump hammer (1,250 g), PUK-hacksaw (290 mm) + 12x saw blades, basin nut wrench, stone chisel flat (300 x 16 mm), Ratched key ROCLICK 19 mm, UNI-stepped key + ratchet, EUROLINE screwdriver set (Phillips), chassis punch (32 mm round), wooden ruler (2 m), carpenter pencil, TUBE CUTTER 35 (6-35 mm), MINICUT I PRO (3-16 mm), extension key, corner pipe wrench Super S (1.1/2"), cutter knife, ROGRIP F 10" 1K, installer toolbox, dimensions: 530 x 200 x 200 mm

Model		No.
Apprentice set, 50 pcs.	1	19166

General purpose tool set, 57 pcs.

Tool bag with a lot of pockets and tool holders with a waterproof plastic bottom. The set offers a good selection of high quality tools for every craftsman.



Set (No. 1000001425) includes: TUBE CUTTER 35 DURAMAG (6 - 35 mm), UNI-stepped key + ratchet, Uni-small saw PUK, 10x saw blade for PUK-saw metal, saw bow ROBO Super, 10x saw blades BI-METALL HSE 4 Plus, Ratched key ROCLICK 19 mm, EUROLINE screwdriver set (2x PH, 4x Slot), spirit level, carpenters pencil, flexible ruler, MINICUT I Pro (3-16 mm), profi universal knife, hammer with hickory wooden handle, electrician chisel, flat, sanitary four way key, ROGRIP M XL (3.1/2"), ROGRIP M 10" 1K, ROGRIP M 7" 1K, ROCUT TC 42 (0-42mm), SWO adjustable wrench 8", tool bag (450 x 285 x 335 mm)

Model	No.
General purpose tools set, 57 pcs.	1000001425

General purpose tool set, 17 pcs.

Compact tool bag with a lot of pockets and tool holders with a waterproof plastic bottom. The set offers a good selection of high quality tools for every craftsman.



Set (No. 1000001745) includes: EUROLINE screwdriver set, water pump pliers SP 10", water pump pliers SP 7", professional cutter knife, MINI MAX Tube Cutter, 3-28 mm, GRATFIX HSS with spare blade, sanitary four way key multifunctional 3/8-1", flexible ruler, wooden, 2 m, aluminum spirit level, carpenter pencil, safety glasses UVEX, tool bag (280 x 360 x 230 mm)

Model	No.
General purpose tools set, 17 pcs.	1000001745

ROCASE case system

	ROCASE 4212	ROCASE 4407	ROCASE 4414	ROCASE 6414	ROCASE 6427
					
	No. 1300003334	No. 1300005506	No. 1300003541	No. 1300003336	No. 1300003337
Outer dimension:	390 x 190 x 120 mm	390 x 390 x 70 mm	390 x 390 x 140 mm	590 x 390 x 140 mm	590 x 390 x 270 mm
Inner dimension:	377 x 150 x 100 mm	349 x 356 x 51 mm	348 x 352 x 122 mm	548 x 352 x 122 mm	548 x 352 x 250 mm
Volume in l:	5.7 l	6.3 l	14.9 l	23.5 l	48.2 l
Weight:	0.63 kg	1.2 kg	1.30 kg	1.89 kg	2.64 kg
Color:	red, anthracite	red	red, anthracite	red	red
Quantity of inlays (currently changed):	7		16	6	3



Model	No.
ROCASE 4212 red, without inlay 39 x 19 x 12 cm	1300003334
ROCASE 4212 anthracite, without inlay, 39 x 19 x 12 cm	1300003649
ROCASE 4407 red, without inlay 39 x 39 x 7 cm	1300005506
ROCASE 4414 red, without inlay 39 x 39 x 12 cm	1300003541
ROCASE 4414 anthracite, without inlay, 39 x 39 x 14 cm	1300003338
ROCASE 6414 red, without inlay, 59 x 39 x 14 cm	1300003336
ROCASE 6427 red, without inlay, 59 x 39 x 27 cm	1300003337

General purpose tools

Case system

ROCASE shoulder belt

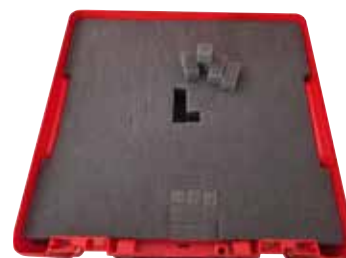
Model	No.
ROCASE shoulder belt with logo	1500002239

ROCASE 4212/4414 foam inlay

Model	No.
ROCASE 4212 foam inlay	1500002449
ROCASE 4414 foam inlay	1500002450



No. 1500002239



No. 1500002450

ROCASE 4414 with tray and ROBOX

Set includes: ROCASE 4414, 2x ROBOX tray, 12x ROBOX B2350 (No. 1500002641)

Model	No.
ROCASE 4414 red, with 2 trays and ROBOXES	1000002108

ROBOX set for ROCASE 4414

Set includes: 1x ROBOX tray, 6x ROBOX B2350 (No. 1500002641)

Model	No.
ROBOX set for ROCASE 4414	1000002109



No. 1000002108



No. 1000002109



No. 1500002763



No. 1500002641

ROBOX

Model	No.
ROBOX B2350, 192 x 114 x 50 mm	1500002641
ROBOX B2650, 364 x 114 x 50 mm	1500002763

ROCASE 4407 with ROBOX

The ROCASE with a transparent lid is compatible with the other cases. In the inside of the case there is a structure to fix the ROBOXes.

KEY FEATURES:

- Optimisation of the daily work because items are perfectly organised into the case

Set includes: ROCASE 4407, 6x ROBOX B2350 (No. 1500002641)

Model	kg	No.
ROCASE 4407 with ROBOX, 39 x 39 x 7 cm	1.7	1000002625



ROCASE trolley

The ROCASE trolley allows an easy transportation of the ROCASE system and other bulky loads. It is foldable really easily and can be stored in the car. To fix the load at the trolley there is a strap included.

KEY FEATURES

- Load capacity up to 120 kg
- Ideal to carry ROCASEs
- Big wheel diameter: easy to go over stairs
- Including a long strap with hooks to fix the load

Model	kg	No.
ROCASE trolley, 78 x 48.5 x 6 cm	7.0	1000002628



Cases not included

ROBUCKET

The ROBUCKET is a tool bucket for a versatile usage and can be fixed at the ROCASEs. To organise also small items in the bucket there is a ROBOX B2650 in the set included.

KEY FEATURES

- Handle allows comfortable transport
- ROBOX B2650 can be stored inside the bucket to stow accessories
- Liter display in the inside of the bucket
- Belt mount for shoulder straps

Model	kg	No.
ROBUCKET with 1x ROBOX B2650, 39.5 x 31.2 x 32.1 cm	1.6	1000002627



Hand tool kit 4414, 18 pcs.

Tool set in the ROCASE system with useful bags and tool holders.

KEY FEATURES

- Wide and practice-oriented tool range
- Dimensions: 390 x 390 x 140 mm

Set (No. 1000001955) includes:
TUBE CUTTER 35 DURAMAG, ROCUT TC 42, ROGRIP M 7" 1K, ROGRIP M 10" 1K, ROGRIP XL, pipe wrench 1", uni stepped key set and ratchet, SWO adjustable wrench, EUROLINE screwdriver set, standard spirit level 430 mm, ROMATIC and ruler, shoulder belt with logo, in ROCASE completely

Model	No.
Hand tool kit 4414, 18 pcs.	1000001955



Index

Alphabetical

Item	Page	Item	Page	Item	Page
3-piece pressure hose sets	283	Clutch jaws	238	Flange adaptor clamping unit	260
A		Concrete / masonry fixing set	51	Flanged riveted expander heads	86
ACCESSORIES HD		Copper rings 1.1/4"	51	Flaring and bending set	98
13/100 – 17/190 – 19/180	251	Copper tube bending springs	63	Flexible pipe welding attachments	167
Adaptor magazines	238	Corner pipe wrench 45°	307	Four-blade cutter	244
AIRPROP	160	Corner pipe wrench 45°, SUPER S	307	Funnel auger	242, 243
ALLGAS 2000 PS 0.5 / 2 Basic	169	Cross-blade cutter, serrated	242, 244	G	
ALLGAS 2000 PS 0.5 / 2 Compact	167	Cutter knife	333	Gas test plug / adaptor	191
ALLGAS 2000 set	166	Cutter wheels	26	General purpose tool set, 13 pcs.	334
ALLGAS 2000 welding tips	167	Cutting disc assortment	326	General purpose tool set, 57 pcs.	334
ALLGAS Mobile Pro	168	Cylinder pressure reducer	173	GRATFIX HSS / UNIGRAT	34
All-purpose marker	333	Cylinder transport trolley	172	Grease cutter	244
Analogue manifolds	282	D		Grooved water pump pliers CL	305
Apprentice set, 50 pcs.	334	Deburrer adaptor I / II	33	H	
Automatic ratchet telescopic pipe cutter	17	Double clamp short	270	Hand roll groover 1 - 12"	146
B		drain cleaning spirals	240	Hand tool kit 4414, 18 pcs.	337
Ball head cutter	246	Drop-head auger	243	Hand wire brushes	175
Basic clamping set 110 mm	260	Dual hoses A/O	172	Hard solder paste LP 5	178
Basic clamping set P 160 SANILINE	262	DURA LAZR TEC	112	Hard solder powder HKM	178
Basic clamping set P 250 A	264	DuraFlex spiral and tool set	249	Hard solder rings S 2	178
Basin nut pliers	315	DX High Speed Plus universal drill bits	49	Hard solders	179
Basin nut wrench	315	E		HD 13/100	250
Basin nut wrench set 3/8"	315	EASYGRIP	311	HD 17/190	250
Battery pack system CAS, mains adaptor & charger	215	Electrical edge cutter	320	Heating plate	260, 264
Bending formers	73	Electrical long nose plier	320	Hemp dispenser with roll	333
Bending spray	63	Electrical multi insulation stripper	320	High Speed Plus natural stone	48
Blowback prevention	173	Electrical power combination plier	320	HM cutter blade inserts	26
Bottle connection and adaptors	292	Electrical power edge cutter	320	HSSE 4 Plus	29
Brush attachments	215	Electro-hydraulic expander pistol H1	89	Hydraulic expander system H 600	88
Bulb auger	242	ENORM 4"	20	I	
Bulb auger, long	243	Ergonomic electrical installation plier	320	INOX Profi Plus	326
Bulb Auger, short	243	EUROLINE	316	INOX-Profi Plus	326
Burners cleaner	174	Expander A0	85	Interchangeable press jaw compact	114
C		Expander adaptor type S	86, 89	Internal brushes for copper pipe	175
Calculation examples		Expander head compatibility	90	J	
ROBEND 3000 / ROBEND 4000	75	Expander head ROLOCK and standard	84	Jacket pipe cutter	27
Calculation examples		Expander head type S	86	Join the press revolution!	106
TUBE BENDER MAXI	74	Extensions	162	L	
Carbide-tipped cutters	242, 246	Extensions for drill bits	52	Lightweight steel cylinders, filled	172
Carpenter pencil	333	Extraction rotor RODIADUST	53	Lump hammer	330
Cartridge extractor set	318	Extractor cam pincer	94	M	
CAS battery packs and charger	329	F		Magnet welding mirror	174
Chain pipe cutter	17	Fitter's hammer	330	Manifold sets	282
Chain pipe vice	331	Fitting key	310	Manual drain cleaner type 3 S	228
Chain pipe wrench 4" R/L	309	Fitting soft solder according to EN standard	176	Manual trimmer unit	260
Chain pipe wrench HEAVY DUTY	309	Fitting solder 1 S	177	MAPP1) gas	158
Chain-spinning head with spikes	242	Fitting solder 3	177	Maxigas 400	159
Chain-spinning heads	245	Fittings soft solder flux	177	Metal saw frame	29
Chain-spinning heads with spikes	245	Fittings solders	177	MINI MAX	16
Chisel	327, 330	Fittings wrench 90°	310	MINIBEND	62
Chisel screwdriver set EUROLINE	317	Flame reflectors	175	MINICUT 2000	16
IMPAKT				MINICUT I PRO / II PRO	16

Item	Page	Item	Page	Item	Page	
MSR internal bending springs	63	R		ROBULL type E	66	
MULTIBEND standard bender 180°	61		R 550	230	ROBULL type E bending segments	67
Multigas 300	159		R 600	230	ROBULL type ME	68
N			R 650	232	ROBULL type ME	69
Neutralizer powder	224		R 750	232	ROBULL type ME bending segments	69
NIPPEL MAX	145		R600 VarioClean	231	ROCADDY 120 R32 (CL) Analogue/Digital	280
Nitrogen set	284		Ratchet pipe deburrer 1/4 - 2"	145	ROCAL 20 / ROMATIC 20	
O			Ratchet spanner ROCLICK	314	ROCAL Acid Multi / Plus	224
One-handed corner pipe wrench 90°	309		RE 17 cutting tips and heating burners	171	ROCAL 4 Plus - 30 m	212
One-handed pipe wrench ALUDUR	308		RE 17 three-gas system AMS 10/10	170	ROCAM 4 Plus - 65 m	213
One-handed pipe wrench STILLSON	308	RE 17 three-gas system AMS 5 and 10	170	ROCAM 4 Plus mini module	213	
One-handed pipe wrench HEAVY DUTY	308	RE 17 three-gas system AMS 5/5	170	ROCAM camera heads	214	
One-handed pipe wrench OFFSET PATTERN HEAVY DUTY	309	RE 17 UNIVERSAL pipe welding set	171	ROCAM PE-X expander power torque	83	
Oxy-acetylene hoses	172	RE 17 welding attachments	171	Rocase 4212/4414 pluck foam inlay	336	
Oxygen hoses	172	RE 17 welding attachments, bendable	171	ROCASE 4407 with ROBOX	336	
Oxygen refilling bend	173	RE 17 wing-lever cutting attachment	171	ROCASE 4414 with tray and ROBOX	336	
P		Reducing / extension pieces	249	ROCASE case system	335	
Parallel vice	331	Reduction inserts narrow P 110	260	Rocase shoulder belt	336	
Peeling device	270	Reduction inserts P 160 SANILINE	262	ROCASE trolley	337	
Pipe cutters, cutting wheels and spare parts	21	Reduction inserts P 250 A	264	ROCHECK	318	
Pipe roughing wrench 3/8 - 2"	145	Reduction inserts wide P 110	260	ROCHECK	318	
Pipe supporting column	145	Reeling flaring tool	97	ROCLEAN function	222	
Pipe vice	331	Refilling adaptor	163	ROCLICK	313	
Pipe wrench 90°	307	Refrigerant for air-conditioning units	291	ROCOOL 600	281	
PIPECUT mini	30	Replacement safety foot switch	145	ROCUR	22	
PIPECUT mini sets	31	Re-Rounding clamps	270	ROCUR TC 26 / TC 32 PS 26 / PS 42 S / PS 35 S	24	
Plastic pipe chamfering unit	272	Retrieving auger	242, 243	ROCUR TC 50 / TC 75 Professional	24	
Plate fin comb	293	RO AG8000 cordless angle grinder	325	ROCUR TC 63 Professional	24	
Precision die heads	138, 144	RO DD60 cordless drill driver	321	ROCUR 110	26	
Precision double flaring press DB 10	95	RO FL180 cordless LED lamp	328	ROCUR 110 / ROCUT 160	25	
Precision threading dies	144	RO ID400 cordless impact wrench	324	ROCUR 160	26	
Press chains standard	116	RO RH4000 cordless rotary hammer	327	ROCUR 42 Twin Cut	23	
Press jaws compact	113	ROAIRVAC R32	286	ROCUR UKS 160 / 355	271	
Press jaws compact Ø 35 mm	113	ROAIRVAC R32 2.0/5.0 CL	288	ROCUR XL	271	
Press jaws standard	114	ROAIRVAC R32 Series	287	RODIA DRY CLEANER 1600	53	
Press jaws standard 3-elemental	115	ROBEND 3000 / 4000 / 4000 E		RODIACUT 150 / RODIADRILL 160	42	
Press jaws standard sets	115	ROBEND 4000	70, 71	RODIACUT 150 / RODIADRILL 200	42	
PRISMACUT	40	ROBEND 4000 sets	72	RODIACUT 250 / RODIADRILL 500	44	
Pro bender	61	ROBEND H+W PLUS	64	RODIACUT 250 / RODIADRILL 200	44	
Professional sets	306	ROBEND H+W PLUS bender	65	RODIACUT 400 PRO / RODIADRILL 500	46	
Propane hoses	163	ROBEND H+W PLUS bending sets	65	RODIADRILL 160	43	
Propane regulators	163	ROBIT PRO	322	RODIADRILL 200	43, 45	
Propane steel cylinder	163	ROBIT PRO torsion	322	RODIADRILL 500	45, 47	
Protective rubber cap	173	ROBO Mini	29	RODIADRILL Ceramic	41	
Pull bending	75	ROBO Super	29	RODRUM M & L drums	237	
Push bending	73	ROBOX	336	RODRUM M&L	236	
Q		ROBOX plier sets	306	RODRUM S	233	
Quad clamps	270	ROBOX set for Rocase 4414	336	RODRUM VarioClean	235	
Quick clamping column	51	ROBOY clamping workbench	331	ROFAST pliers wrench	310	
		ROBUCKET	337	ROFIRE 4	157	
				ROFIRE 4 PIEZO	157	

Index

Alphabetical

Item	Page	Item	Page	Item	Page
ROFIRE GLOBAL	156	ROREC PRO Digital	290	SANIFRESH	292
ROFIRE Swivel PRO cyclone piezo	156	ROSCALE 120	291	SANIGRIP/SANIGRIP PL	310
ROFIRE Swivel PRO twin	156	ROSCOPE i2000	207	Sanitary four way key	312
ROFIX adaptor	138	ROSCOPE i2000 & ROCAM 4 Plus app	211	Schrader valve tool	293
ROFLAME 4 PIEZO	156	ROSCOPE i2000 module 25/16	209	Screwdrivers sets	316
ROFLARE REVOLVER	96	ROSCOPE i2000 module 25/22	208	SDS-plus hammer drill	51, 328
ROFROST App	199	ROSCOPE i2000 module	210	Separating pin	239
ROFROST CO2 Set	200	ROLOC PLUS	210	Serrated forked cutter	246
ROFROST Freezer Heads	201	ROSCOPE i2000 module TEC	208	Sheet metal crimping pliers	319
ROFROST Turbo R290 1.1/4"	197	ROSCOPE mini	206	Silver hard solders Ag 134S	181
ROFROST Turbo R290 1.1/4"/	196	ROSLICE	18	34 Cu U flux-covered	
ROFROST Turbo R290 2"	198	ROSOL 1 S	177	Silver hard solders Ag 145S	181
ROFROST Turbo 2"	198	ROSOL 3	177	45 Cu / S 45 Cu U flux-covered	
ROFROST Turbo reduction inserts	199	ROSOL 3	177	SMK-spirals	241
ROFUSE 400 / 1200 TURBO	265	ROSOL soldering paste	177	Soldered joints	176
ROGRAT MSR deburrer and chamfering tool	35	ROSOLAR PUMP	225	Soldering flux and container forhydrochloric acid	174
ROGRAT MSR system - manual chamfering attachments	35	ROSOLAR PUMP PLUS	225	Space welding	40
ROGRIP F	302	ROSPI H+E PLUS	227	Spade head cutter	242, 244
ROGRIP M	302	ROSPIMATIC CL	229	Spare extractor hooks	93
ROGRIP plier sets	306	ROTEST	193	Spare parts	264
ROGRIP XL	303	ROTEST Electronic 4	193	Special diamond drills for tiles and natural stone	51
ROGROOVER 1 - 12"	147	ROTEST GW 150/4	190	SPEED STAR DX	50
ROGROOVER 1 - 6"	146	ROTEST GW Digital V3	188	Spiral and tool sets	248
ROKLIMA MULTI 4F	278	ROTEST GW Digital V3 - RoData Mobile App	189	Spiral baskets	
ROLeak Aqua Plus	192	ROTEST GW Digital V3 - RoData V3 PC-Software	189	Spiral guide gloves	239
ROLEAK Pro	285	ROTHENBERGER high-performance		Spiral guide hoses	238
Rolling skids	215	ROTHERM 2000	164	Spiral retrieving device	239
ROLOCK COMBI KIT expander / tee-extractor	91	ROTHERM 2000 soft soldering set	165	Spiral sawtooth cutter	242, 244
ROLOCK expander power torque	82	ROTORQUE AIRCON / REFRIGERATION	99	Spirals 8 mm / 10 mm	249
ROLOCK expander power torque sets	83	ROTRAC 28 / 42	16	Squeezing device	270
ROLOT S 15	180	ROVLIES cleaning pads	175	S-SMK-spirals	241
ROLOT S 2	179	ROWELD HE heating plates	269	S-spirals	241
ROLOT S 5	180	ROWELD P 110	259	Standard bender 180°	62
ROLOT S 94	179	ROWELD P 110 basic machine	260	Standard solder according to EN ISO standard	176
ROMATIC and ruler	319	ROWELD P 125	269	Standard spirals	241
ROMAX 3000 AC	110	ROWELD P 160 SANILINE	261	Standard spirit level	319
ROMAX 4000	108	ROWELD P 160 SANILINE	262	Standard two handed bender 90°	61
ROMAX 4000 sets	109	ROWELD P 250 A	263	Step expander A1	87
ROMAX AC ECO	111	ROWELD P 250 A set	264	Straight auger	243
ROMAX Compact TT (TWIN TURBO)	104	ROWELD P 63 S-6 Sword	267	Strap and fittings wrench	311
ROMAX Compact TT sets	105	ROWELD P 63 S-6 Sword sets	268	SUPER 1.1/4" and 2"	20
RONOL	139	ROWELD P 63 S-6 Sword sets	268	SUPER 1.1/4" and 2" INOX	20
RONOL SYN	139	ROWELD ROFUSE Sani 160/315	266	SUPER CUT	128
ROOFING set	162	ROWELD type Premium CNC	256	SUPER CUT ratchet arm	131
ROPOWER 50 R	140, 141	ROWELD type Professional	258	SUPER CUT sets Ø 1/2 - 1.1/4"	129
ROPOWER HANDY	228	ROWONAL care and rust remover	239	SUPER CUT sets Ø 3/8 - 1.1/4"	129
ROPOWER profile cable	241	ROXY 400 L	169	SUPER CUT sets Ø 3/8 - 2"	129
ROPULS eDM App	221	RP 30	187	SUPER FIRE 3	152
ROPULS eDM flushing compressor	220	RP 50-S / RP 50-S INOX	185	SUPER FIRE 3 HOT BOX	153
ROPULS flushing compressor	221	RP PRO III	186	SUPER FIRE 4	154
ROPUMP	226	S		SUPER FIRE 4 HOT BOX	155
ROPUMP SUPER PLUS	226	Safety igniters	173	SUPER FIRE 3 basic set	153
RO-QUICK	313	Safety propane handles	163	SUPER FIRE 4 basic set	155
ROREC	289	Safety T-couplings	249	Supergas C 200 TSS	159
		SANI KIT	130, 131	SUPERTRONIC 1250	132
				SUPERTRONIC 1250 set	133

Item	Page	Item	Page
SUPERTRONIC 2 SE	143	UNIDRILL Automatic 28/42	94
SUPERTRONIC 2 SE / 3 SE / 4 SE	142	Universal flaring tool	98
SUPERTRONIC 2000	134	Universal internal & external deburrer	32
SUPERTRONIC 2000 E	136	Universal workbench	332
SUPERTRONIC 2000 set	135, 137		
SUPERTRONIC 3 SE	143	V	
SUPERTRONIC 4 SE	143	Vacuum pump RODIA-VAC	51
Surface-heating burner heads	162	Vacuum-sets	51
SWO adjustable wrench	314	VDE screwdriver set	317
T		Voltage Detector E-Detector 90–1000 V	320
Tee-extractor	93	W	
Tee-extractor ratchet	94	Water extraction systems	52
Tee-extractor sets	92	Water pump pliers SP	304
Telescopic basin nut wrench	315	Water pump pliers type SPK	305
Telescopic workbench	332	Water supply	52
Telescoping guide tubes	239	WC-BLITZ RO-3 toilet auger	228
Thread interfaces	51	Welding blanket	175
Threading dies	138	Welding goggles EN 166	174
Tool bag	333	Working unit	332
Tool bag universal	333		
Tool bag, small	333		
Tool set Climate I + II	283		
Tool set L	247		
Tool set S	247		
Toolboxapprentice	333		
Toolkit sets	322		
Torch spanner	174		
Torque wrench set	99, 292, 314		
TP 25	187		
Trendy shouldertoolbox	333		
Trendy tool bag	333		
Trimmer adaptor P 160 SANILINE	262		
Tripod stand	238		
Tripod uni workbench	332		
TUBE BENDER	58		
TUBE BENDER MAXI	59		
TUBE BENDER MAXI MSR	60		
TUBE CUTTER 30 PRO / 50	17		
TUBE CUTTER 30 PRO INOX	18		
TUBE CUTTER 35 / 42 Pro	14		
TUBE CUTTER 35 / 42 PRO INOX	19		
TUBE CUTTER 35 DURAMAG counter display	15		
TUBE CUTTER 35 MSR / 42 PRO MSR /42 PRO PVC	28		
TUBE CUTTER 42 XL	15		
TUBE CUTTER 67 / 125 / 168 PL Automatic	27		
TUBE CUTTER CSST	19		
TUBE CUTTER INOX	19		
TURBOPROP	161		
Two-way root cutter	242, 246		
U			
UNI small saw PUK	29		
UNI stepped key set	312		
UNICUT HM	323		

Index

Numerical

No.	Page	No.	Page	No.	Page	No.	Page	No.	Page
O									
015060X	115	015282X	118 - 123	015385X	117 - 123	070017D	16, 17, 21	070914X	138
015062X	115	015282X	119	015389X	117 - 123	070027(C)	21	070915X	138
015063X	115	015283X	118 - 123	015391X	117 - 123	070027DB	15	070917X	138
015068X	115	015284X	118 - 123	015392X	118	070028D	21, 28	070918X	138
015080X	115	015291X	118	015393H	117 - 123	070046D	20, 21	070919X	138
015101X	117 - 123	015292X	118	015393X	117 - 123	070051D	20, 21	070920X	138
015102X	117 - 123	015293X	118	015394X	118	070056D	15, 18-21	070921X	138
015103X	117 - 123	015294X	118	015395X	117 - 123	070057D	17, 21	070945X	138
015104X	117 - 123	015302X	118 - 123	015396X	118	070061D	20, 21	070946X	138
015105X	117 - 123	015304X	118 - 123	015397X	118	070088D	20, 21	071533D	326
015106X	117 - 123	015306X	118 - 123	015398X	117 - 123	070089D	20, 21	071534D	326
015151X	117 - 123	015307X	118 - 123	015399X	117 - 123	070110X	307	072070X	226
015152X	117 - 123	015308X	118 - 123	015401X	117 - 123	070111X	307	072185F	245
015153X	117 - 123	015311X	118 - 123	015530X	118 - 123	070112X	307	072945X	248
015154X	117 - 123	015312X	118 - 123	015531X	118 - 123	070121X	307	072955X	248
015155X	117 - 122	015313X	118 - 123	015532X	118 - 123	070122X	307	072956X	248
015161X	117 - 123	015314X	118 - 123	015533X	118 - 123	070123X	307	072962X	248
015162X	117 - 123	015315X	118 - 123	015534X	118 - 123	070124X	307	072967X	248
015163X	117 - 123	015317X	118 - 123	015580X	118 - 123	070130X	306	088840D	18
015164X	117 - 123	015318X	118 - 123	015581X	118 - 123	070131X	307	088841D	18
015180X	117 - 123	015321X	117 - 123	015582X	118 - 123	070132X	307	088842D	18
015181X	117 - 123	015322X	117 - 123	015583X	118 - 123	070133X	307	1	
015182X	117 - 123	015323X	117 - 123	01700RD	284, 292	070134X	307	11004	85
015183X	117 - 123	015324X	117 - 123	023020X	59	070135X	306	11006	32
015211X	117 - 123	015325X	117 - 123	023021X	59	070140X	306	11007	86, 89
015212X	117 - 123	015326X	117 - 123	023022X	59	070188D	21, 28	11008	84
015213X	117 - 123	015327X	117 - 123	023090X	59	070522D	305	11010	84
015214X	117 - 123	015328X	117 - 123	023091X	59	070690X	31, 332	11012	84
015215X	117 - 123	015329X	117 - 123	035510-A/-B	159	070699X	332	11014	84
015216X	117 - 123	015330X	117 - 123	035521-A	158, 168	070705X	331	11015	84
015217X	117 - 123	015331X	117 - 123	035521-B	158	070735X	331	11016	84
015218X	117 - 123	015333X	117 - 123	035521-C	158	070780X	129	11018	84
015219X	117 - 123	015334X	117 - 123	035570-A/-B	159	070781X	129	11020	84
015220X	117 - 123	015335X	117 - 123	035648X	153, 155	070790X	129	11022	84
015222X	117	015336X	117 - 123	035780X	169	070821X	138	11028	84
015223X	117	015337X	117 - 123	035901-A/-B	159	070822X	138	11032	84
015224X	117	015338X	117 - 123	045268D	175	070823X	138	11035	84
015225X	117	015339X	117 - 123	053890X	268	070824X	138	11038	84
015226X	117	015351X	118 - 123	053891X	268	070825X	138	11040	84
015227X	117	015352X	118 - 123	053892X	268	070826X	138	11042	84
015230X	118 - 123	015353X	118 - 123	053893X	268	070831X	138	11044	33
015231X	118 - 123	015354X	118 - 123	053894X	268	070832X	138	11045	33
015232X	118 - 123	015355X	118 - 123	053895X	268	070833X	138	11052	84
015233X	118 - 123	015357X	118 - 123	053896X	268	070834X	138	11053	84
015234X	118 - 123	015358X	118 - 123	053897X	268	070835X	138	11054	84
015260X	117 - 123	015362X	118 - 123	055053D	21, 26	070836X	138	11055	84
015261X	117 - 123	015364X	118 - 123	055054D	21, 26	070840X	131	11056	84
015262X	117 - 123	015366X	118 - 123	055074D	21, 26	070842X	138	11057	84
015263X	117 - 123	015367X	118 - 123	056370X	144	070843X	138	11058	84
015264X	117 - 123	015368X	118 - 123	056371X	144	070849X	138	11059	84
015265X	117 - 122	015370X	117 - 123	057950X	66	070850X	138	11062	84
015269X	117 - 123	015371X	117 - 123	057961X	66	070869X	138	11063	84
015271X	118 - 123	015374X	117 - 123	057966X	66	070870X	138	11078	87
015277X	118 - 123	015376X	117 - 123	057969X	68	070891X	129	11086	87
015280X	118 - 123	015377X	117 - 123	057972X	68	070892X	129	11087	87
015281X	118 - 123	015378X	117 - 123	057973X	68	070908X	138	11089	87
		015379X	117 - 123	070007D	16, 21	070912X	138	11093	87
		015380X	117 - 123	070007X	16	070913X	138		

No.	Page	No.	Page	No.	Page	No.	Page	No.	Page
11323	86	12517	83	14884	118 - 123	1000000223	96	1000001431	61
11325	86	12518	83	14885	118 - 123	1000000224	99	1000001500	116
11328	86	12521	83	14886	118 - 123	1000000225	99	1000001501	116
11332	86	12522	83	14895	114	1000000230	96	1000001502	115
11335	86	12524	83	15705	111	1000000231	96	1000001545	72
11336	86	12526	83	15730	111	1000000235	117 - 123	1000001549	72
11342	86	12535	83	15740	111	1000000236	117 - 123	1000001550	72
11346	86	12536	83	15750	111	1000000328	303	1000001551	72
11348	86	12537	83	15760	111	1000000383	258	1000001552	72
11358	86	12538	83	19166	334	1000000445	61	1000001553	72
11362	86	12541	83	100108	315	1000000529	168	1000001554	72
11364	86	12601	91	100109	315	1000000532	271	1000001559	72
11376	86	12602	91	100110	315	1000000539	281	1000001561	73
11380	86	12604	91	111405	328	1000000540	281	1000001563	73
11400	85	12605	91	111411	328	1000000541	281	1000001564	72
11955	86	13002	88	111419	328	1000000558	168	1000001565	72
11958	86			111424	328	1000000563	256	1000001566	72
11962	86	13100	88	111429	51, 328	1000000569	281	1000001567	72
11968	86	14000	35	111447	328	1000000570	281	1000001630	155
11975	86	14122	35	111452	328	1000000572	281	1000001647	321
12001	89	14126	35	111455	328	1000000620	168	1000001648	324
12013	88	14250	35	168605	289	1000000629	168	1000001649	325
12017	89	14707	122, 123	168713	289, 290	1000000633	173	1000001650	327
12018	89	14708	117 - 123	169200	287	1000000642	168	1000001651	328
12078	89	14709	122, 123	170016	279, 292	1000000720	146	1000001652	105, 107, 109, 329
12080	89	14822	117 - 123	170501	282	1000000721	146		31, 72,
12097	89	14823	117 - 123	170502	282	1000000722	146	1000001653	105, 107, 109, 215, 329
12400	82	14824	117 - 123	170545	282	1000000723	146		31, 72,
12408	84	14825	117 - 123	170546	282	1000000743	168	1000001654	105, 107, 109, 215, 329
12410	84	14826	117 - 123	170547	282	1000000762	173		105, 107, 109
12412	84	14832	118 - 123	170600	282	1000000764	173	1000001691	105, 107, 109
12414	84	14833	118 - 123	170601	282	1000000842	209		236
12415	84	14834	118 - 123	170602	282	1000000850	146	1000001711	236
12416	84	14835	118 - 123	170604	283	1000000860	208	1000001712	236
12418	84	14836	118 - 123	170605	283	1000000861	210	1000001713	236
12420	84	14837	118 - 123	170606	282	1000000999	265	1000001714	236
12422	84	14838	118 - 123	170607	282	100001000	265	1000001727	237
12428	84	14842	119 - 123	170608	282	1000001001	110	1000001728	237
12432	84	14843	117 - 123	170912	291	1000001068	306	1000001729	237
12435	84	14844	117 - 123	170932	291	1000001126	116	1000001730	237
12438	84	14845	117 - 123	170950	292	1000001134	220	1000001731	237
12440	84	14846	117 - 123	170960	291	1000001231	287	1000001732	237
12442	84	14847	117 - 123	170961	291	1000001256	234	1000001734	328
12452	84	14848	117 - 123	171505	282	1000001257	234	1000001738	72
12453	84	14849	114	173204	292	1000001273	115, 117, 119 - 123	1000001745	334
12454	84	14852	118	173205	292			1000001747	19
12455	84	14853	118	173206	292	1000001274	115, 117, 119 - 123	1000001748	15
12456	84	14854	118			1000001275	234	1000001762	226
12457	84	14855	118	175001	99, 292, 314	1000001276	234	1000001786	107
12458	84	14863	117 - 123	1000000046	16	1000001308	234	1000001807	115
12459	84	14864	122, 123	1000000124	117	1000001391	116, 117	1000001808	115
12462	84	14865	117 - 123	1000000125	117	1000001392	116, 117	1000001810	115, 117
12463	84	14866	122, 123	1000000138	279	1000001393	116, 117	1000001811	115, 117
12500	83	14867	122, 123	1000000145	221	1000001394	116, 117	1000001836	215
12503	83	14868	117 - 123	1000000173	117 - 123	1000001425	334		
12505	83	14869	114	1000000190	221, 222	1000001426	282		
12509	83	14882	118 - 123	1000000212	146	1000001427	282		
12511	83	14883	118 - 123	1000000222	96				

Index

Numerical

No.	Page	No.	Page	No.	Page	No.	Page	No.	Page
1000001840	109			1000003233	288	1500000031	283	1500002256	237
1000001856	109	1000002266	113, 117, 119 - 123	1000003345	231	1500000032	283	1500002257	237
1000001877	110			1000003346	231	1500000052	209	1500002258	237
1000001879	109	1000002267	113, 117, 119 - 123	1000003347	235	1500000057	210	1500002259	237
1000001898	107	1000002268	206	1000003348	235	1500000087	333	1500002260	237
1000001923	109	1000002298	229	1000003371	235	1500000115	224	1500002261	237
1000001924	109	1000002299	229	1000003372	231	1500000116	224	1500002262	237
1000001925	109	1000002307	105	1000003374	31	1500000117	224	1500002263	237
1000001926	109	1000002358	156	1000003391	72	1500000120	215	1500002264	237
1000001927	109	1000002359	157	1000003392	72	1500000122	214	1500002265	237
1000001932	109	1000002360	157	1000003393	72	1500000123	214	1500002266	237
1000001955	337	1000002364	155	1000003394	72	1500000134	147	1500002267	237
1000001959	111	1000002366	155	1000003398	31	1500000135	225	1500002268	237
1000001989	106	1000002368	155	1000003532	106	1500000136	225	1500002271	237
1000002002	15	1000002369	153	1000003536	106	1500000157	222	1500002449	336
1000002011	135	1000002370	153	1000003622	280	1500000200	222	1500002450	336
1000002016	135	1000002371	153	1000003623	280	1500000201	222	1500002453	322
1000002035	321	1000002399	287	1000003624	106	1500000202	222	1500002454	322
1000002036	324	1000002400	107	1000003625	106	1500000203	221, 222	1500002613	212
1000002037	325		31, 105,	1200000526	271		17, 20,	1500002614	212
1000002038	327	1000002548	107, 109, 329	1300003334	335	1500000236	32, 62, 63	1500002615	213
1000002065	115		31, 105,	1300003336	335			1500002616	213
1000002067	115		107, 109, 329	1300003337	335	1500000237	17, 20, 32, 107	1500002637	290
1000002068	115	1000002549	107, 109, 329	1300003338	335			1500002641	336
1000002069	115			1300003541	25, 335	1500000439	239	1500002677	188
1000002077	19	1000002560	280	1300003542	65	1500000696	208	1500002763	336
1000002085	215	1000002561	280	1300003649	335	1500000789	271	1500002824	327
1000002108	336	1000002625	336	1300004002	65	1500000790	271	1500002825	327
1000002109	336	1000002627	337	1300005045	93	1500000792	271	1500002826	327
1000002111	105	1000002628	337	1300005046	93	1500000793	271	1500002827	327
1000002112	105	1000002630	266	1300005047	93	1500000794	271	1500002828	327
1000002113	105	1000002631	266	1300005048	93	1500000795	271	1500002829	327
1000002114	105	1000002655	113	1300005049	93	1500000817	215	1500002845	191
1000002115	105	1000002683	109	1300005050	93	1500000914	224	1500002846	191
1000002116	105	1000002697	302	1300005051	93	1500000922	192	1500002847	191
1000002117	105	1000002698	302	1300005052	93	1500001235	225	1500002848	191
1000002118	105	1000002699	302	1300005054	93	1500001236	225	1500002851	191
1000002119	105	1000002700	302	1300005055	93	1500001299	333	1500002852	191
1000002120	105	1000002701	302	1300005056	93	1500001320	333	1500002869	156
1000002121	106	1000002702	302	1300005057	93	1500001324	228	1500002876	191
1000002123	105	1000002704	302	1300005058	93	1500001351	147	1500002921	157
1000002124	105	1000002705	302	1300005059	93	1500001352	147	1500002922	157
1000002125	106	1000002713	287	1300005060	93	1500001353	147	1500003000	197
1000002134	114	1000002714	287	1300005061	93	1500001355	155	1500003001	198
1000002135	114	1000002809	105	1300005062	93	1500001509	314	1500003163	320
1000002136	114	1000002945	106	1300005063	93	1500001510	314	1500003164	320
1000002180	322	1000002946	106	1300005064	93	1500001547	319	1500003166	320
1000002181	322	1000002964	261	1300005065	93	1500001548	319	1500003167	320
1000002182	322	1000002967	261	1300005067	93	1500001583	319	1500003168	320
1000002188	306	1000002970	262	1300005506	335	1500001711	147	1500003169	320
1000002189	306	1000002971	262	1300005864	25	1500001990	147	1500003170	310
1000002194	308	1000003011	23	1500000024	283	1500002182	333	1500003296	213
1000002207	106	1000003104	23	1500000025	283	1500002230	333	1500003374	320
1000002222	15	1000003165	31	1500000026	283	1500002239	336	1500003381	292
1000002242	105	1000003199	193	1500000027	283	1500002241	285	1500003464	326
1000002262	147	1000003229	288	1500000028	283	1500002253	237	1500003465	326
1000002263	147	1000003230	288	1500000029	283	1500002254	237	1500003517	221
1000002264	147	1000003231	288	1500000030	283	1500002255	237	1500003533	192

No.	Page	No.	Page	No.	Page	No.	Page	No.	Page
1500003535	192	22126	92	25131	62	26011	95	31050	175
1500003621	31	22127	92	25132	62	26013	95	31090	161
1500003673	31	22135	92	25133	62	26015	95	31091	160
1500003674	31	23001	59	25134	62	26016	95	31092	160
1500003693	31	23002	59	25135	62	26017	95	31094	161
1500003694	31	23003	59, 60	25136	62	26020	98	32077	173
1500003703	241	23004	59	25137	62	27180	94, 312	32081	163
1500003704	241	23005	59, 60	25140	62	27181	94	32088	173
1500003705	249	23006	59	25142	62	222401	97	32201	163
1500003706	235	23007	59	25150	62	222402	97	32207	163
1500003707	235	23008	59	25151	62	222403	97	32223	163
1500003708	235	23009	60	25181	63	222412	97	33079	163
		23010	59	25182	63	222413	97	33310	163
		23011	59	25183	63	222601	98	33311	172
2		23012	59	25185	63	224500	293	35012	156
21300	323	23013	59	25186	63	252100	319	35016	156
21316	323	23014	59	25190	63	259008	284	35178	172
21329	323	23047	59	25308	65	259010	284	35179	172
21334	323	23050	60	25310	65	259060	284	35188	172
21335	323	23051	60	25312	65	211111116	163	35189	172
21395	323	23052	60	25313	65	211121116	163	35199	173
21500	27	23053	60	25314	65	221031500	161	35210	172
21505	27	23065	60	25315	65	221031800	161	35221	172
21575	94	23076	60	25316	65	221131416	160	35222	172
21583	94	23080	60	25318	65	221131616	160	35223	172
21651	34	23083	60	25319	65	221131916	160	35300	166
21652	17, 19, 21, 25, 34	23095	60	25322	65	221132216	160	35303	166
21655	17, 20, 34	24001	58	25401	61	223090716	162	35304	166
21660	17, 20, 34, 107	24006	58	25402	61	223090916	162	35306	166, 167
22010	93	24007	58	25403	61	223214500	162	35307	166, 167
22012	93	24008	58	25404	61	223215100	162	35308	166, 167
22014	93	24048	58	25405	61	223215700	162	35309	166, 167
22015	93	24049	58	25406	61	223216300	162	35312	166, 167
22016	93	24131	58	25441	63	231010000	162	35313	166, 167
22018	93	24132	58	25442	63	232010000	162	35314	166, 167
22028	93	24133	58	25443	63	233510000	162	35315	166, 167
22035	93	24134	58	25445	63	236010000	162	35324	171
22038	93	24500	65	25446	63	242206000	163	35325	171
22042	93	24501	65	25612	73	252010000	162	35326	171
22050	93	24502	65	25614	73	263005400	169	35327	171
22054	93	24503	65	25615	73	263005600	169	35328	171
22060	93	24504	65	25616	73	263005700	169	35329	171
22061	93	24505	65	25618	73	263005800	169	35334	171
22062	93	24508	65	25619	73			35338	171
22063	93	24510	65	25620	73	3		35339	171
22064	93	24512	65	25622	73	30101	163	35341	171
22065	93	24514	65	25625	73	30102	163	35344	171
22066	93	24515	65	25626	73	30913	160	35345	171
22068	93	24516	65	25628	73	30914	160	35347	171
22080	94	24518	65	25652	73	30915	160	35348	171
22100	92	24519	65	25684	73	30916	160	35354	172
22101	92	24522	65	25685	73	30925	163	35400	170
22103	92	24552	65	26001	95	30927	163	35401	170
22109	92	25075	65	26002	95	30954	162	35403	170
22111	92	25076	65	26003	95	30957	162	35436	153
22121	92	25078	65	26004	95	31032	161	35475	171
22124	92	25120	62, 63, 65	26005	95	31042	175	35476	171
		25130	62	26010	95	31043	175	35477	171

Index

Numerical

No.	Page	No.	Page	No.	Page	No.	Page	No.	Page
35479	171	351272	191	53258	270	55030	26	55686	262
35480	171			53259	270	55031	26	55717	264
35580	169	4		53260	270	55032	26	55718	264
35585	169	40005	180	53261	270	55033	26	55719	264
35611	178	40015	180	53262	270	55035	25	55721	264
35629	167	40094	179	53263	270	55047	26	55742	264
35634	173	40202	179	53271	270	55048	26	55743	264
35635	172	40212	179	53272	270	55050	272	55744	264
35636	163	40213	179	53273	270	55051	272	55745	264
35651	169	40500	178	53274	270	55058	272	55746	264
35655	167	40502	180	53275	270	55063	25	55747	264
35695	169	40514	178	53276	270	55075	311	55748	264
35696	169	40515	178	53277	270	55076	311	55749	264
35697	169	40528	178	53278	270	55119	260	55750	264
35698	168	44915	181	53279	270	55120	260	55751	264
35713	169	44916	181	53280	270	55121	260	55752	264
35750	168, 172	44917	181	53281	270	55122	260	55753	264
35782	169	45055	181	53282	270	55124	260	55759	264
35785	169	45056	181	53283	270	55125	260	55768	263
35794	173	45220	177	53285	270	55126	260	55787	260
35800	171	45225	177	53511	268	55127	260	55795	263
36700	165	45250	177	53512	268	55128	260	55807	260
36702	165	45252	177	53513	268	55129	260	55808	260
36710	165	45255	177	53514	268	55130	260	55809	260
36711	165	45257	177	53515	268	55132	260	55826	260
36715	165	45266	177	53516	268	55133	260	55832	260
36720	165	45268	107, 175	54005	262	55134	260	55844	259
36721	165	402308	333	54020	264	55152	260	55851	262, 269
300013	29	402311	333	54040	262	55163	264	55854	264, 269
310411	262	402312	333	54080	262	55199	260	55918	260
321216	260	462212	61	54082	262	55316	262, 269	55924	259
321218	260, 264	462215	61	54083	262	55317	264, 269	56001	144
322823	330	462218	61	54084	262	55318	260	56003	144
322922	330	462222	61	54085	262	55319	260	56006	144
323126	317			54086	262	55321	269	56007	144
350850	310	5		54087	262	55324	260	56008	144
350900	310	52000	24	54088	262	55505	271	56032	144
351043	312	52005	24	54089	262	55517	269	56045	141
351044	312	52010	24	54090	262	55518	269	56047	145
351050	315	52011	24	54091	262	55524	260, 269	56049	141
351220	191	52015	24	54950	26	55536	269	56050	141
351221	191	52016	24	54960	26	55539	269	56051	141, 262
351222	191	52030	24	54961	26	55546	269	56052	144
351223	191	52031	24	55005	24	55585	269	56053	144
351225	191	52040	24	55006	24	55587	269	56054	144
351226	191	52041	24	55007	24	55588	269	56056	145
351227	191	52042	24	55015	24	55589	269	56057	141
351228	191	53200	270	55018	25	55590	269	56058	144
351231	191	53210	270	55019	26	55591	269	56059	144
351232	191	53220	270	55020	26	55592	269	56060	145
351233	191	53240	270	55021	26	55593	269	56061	145
351257	191	53250	270	55022	26	55594	269	56062	145
351260	191	53251	270	55023	26	55595	269	56063	145
351261	191	53252	270	55024	26	55596	269	56064	145
351262	191	53253	270	55025	26	55597	269	56065	145
351263	191	53254	270	55026	26	55598	269	56076	144
351265	191	53255	270	55027	26	55684	262	56077	144
351271	191	53256	270	55029	26	55685	262	56097	144

No.	Page	No.	Page	No.	Page	No.	Page	No.	Page
56098	144	56510	146	61018	191	69601	208	70161	308
56104	144	56511	146	61030	191	69603	208	70162	308
56110	144	56512	146	61041	191			70163	308
56111	144	56514	146	61100	223	7		70166	309
56112	144	56521	146	61105	224	70006	21	70167	309
56114	144	56522	146	61106	224	70010	16, 21	70168	308
56118	144	56523	146	61115	224	70011	16, 21	70169	308
56121	144	57050	143, 147	61120	224	70015	16, 21	70189	308
56122	144	57979	67, 69	61130	187	70023	21	70190	308
56135	144	57981	67, 69	61185	186	70027	15, 107	70191	308, 309
56150	143	57983	67, 69	61186	186	70029	15, 21	70192	308, 309
56153	144	57985	67, 69	61190	223	70030	17, 21	70193	308
56156	144	57986	67, 69	61316	185	70031	21, 27	70194	308, 309
56175	143	57987	67, 69	61700	190	70032	21, 27	70195	308
56180	144	57988	67, 69	61701	190	70033	21, 27	70196	308
56181	144	57989	67, 69	61702	191	70040	20, 21	70197	308
56183	144	57990	67, 69	62211	199		16, 17,	70198	308
56184	144	57991	67, 69	62212	199	70041	18, 21	70199	308
56198	143	58010	67, 69	62213	199	70042	17, 21	70200	308
56199	143	58011	67, 69	62214	199	70045	20, 21	70201	308, 309
56200	143	58012	67, 69	62215	199	70047	21	70202	308
56235	144	58013	67, 69	62216	199	70052	21	70203	308, 309
56236	144	58014	67, 69	62217	199	70053	20, 21	70204	308, 309
56237	144	58015	67, 69	62219	199	70055	15, 19, 21	70205	308
56238	144	58016	67, 69	62221	199	70060	20, 21	70206	308
56250	143		67, 69,	62224	199	70063	21	70207	308
56253	143	58182	238	62226	199	70064	20, 21	70208	308
56254	143	58185	67, 69	62227	199	70065	17, 21	70225	315
56255	143	510105	174	62230	198	70067	21	70226	315
56266	144	510106	174	62231	199	70068	21	70227	315
56268	144	511427	173	62232	199	70070	15, 19, 21	70228	315
56269	144	511428	173	62233	199	70072	15, 21, 28	70235	309
56271	144	530250	174	62234	199	70074	141	70240	311
56288	144	540360	173	62235	199	70080	16, 21	70241	311
56289	144	540365	173	62236	199	70081	21	70242	309
56291	144	540620	174	62237	199	70086	20, 21	70243	309
56294	144	540621	174	62291	199	70087	20, 21	70244	309
56295	144	540622	174	65000	193	70105	16, 21	70245	309
56296	144	540625	174	65008	139	70108	15, 21, 28	70246	309
56335	145	540626	174	65010	139	70109	15, 21, 28	70247	309
56369	144	540627	174	65013	139	70113	307	70263	309
56372	144	540640	174	65015	139	70114	307	70264	309
56373	144	540675	174	65030	200	70115	309	70265	309
56374	144	540851	174	65035	201	70116	309	70266	309
56379	144	540855	174	65036	201	70125	307	70267	309
56380	144	561351	175	65037	201	70142	17, 21	70268	311
56465	143			65038	201	70148	308	70269	311
56466	143	6		65039	201	70150	308	70285	17, 21
56475	143	60200	185	65040	201	70151	308	70286	17, 21
56488	141, 143	60201	185	65041	201	70152	308	70289	145
56500	145	60203	185	65042	201	70153	308	70296	145
56501	145	60250	187	65044	201	70154	308	70340	19, 21
56504	146	60251	187	69111	215	70155	308	70341	19, 21
56505	146	60999	185	69112	215	70156	308	70350	308
56506	146	61001	186	69113	215	70157	308	70351	308
56507	146	61011	191	69117	215	70158	308	70352	308
56508	146	61014	191	69118	215	70159	308	70353	308
56509	146	61017	191	69119	215	70160	308	70354	308

Index

Numerical

No.	Page	No.	Page	No.	Page	No.	Page	No.	Page
70355	308	70714	331	72161	243	72341	245	72915	238
70356	308	70715	331	72162	243	72348	245	72918	237
70374	308	70721	331	72163	243	72350	246	72936	247
70375	308	70722	331	72164	244	72351	246	72937	247
70376	308	70731	331	72165	243	72360	244	72938	247
70377	308	70732	331	72166	244	72363	243	72939	247
70378	308	70733	331	72168	246	72365	246	72942	229
70379	308	70734	331	72169	244	72366	246	73280	312
70380	308	70740	332	72170	244	72375	244	73297	312
70401	16, 21	70751	146, 332	72171	244	72376	244	73298	312
70402	16, 21	70752	332	72172	246	72377	244	73570	316
70413	313	71019	17, 21	72175	244	72398	246	73571	316
70414	313	71085	18, 21	72176	228, 244	72412	249	73575	317
70415	310	71206	29	72177	244	72413	229, 249	74629	208, 209
70416	310	71213	29	72178	244	72414	249	76020	250
70418	314	71215	29	72185	245	72415	249	76065	251
70419	314	71216	29	72186	245	72420	249	76068	251
70420	314	71217	29	72187	245	72421	249	76070	250
70421	314	71222	29	72188	245	72422	249	76088	251
70422	314	71250	135	72193	246	72423	249	76089	251
70423	314	71251	135	72203	243	72424	249	77050	330
70424	314	71256	135	72208	243	72425	229	77397	319
70425	314	71257	135	72210	249	72428	241	77506	251
70426	314	71258	135	72211	249	72431	241	78551	228
70427	314	71259	135	72221	243	72433	241	701011500	20, 21
70439	313	71271	138	72222	243	72435	241	750004100	17
70490	313	71272	131	72223	246	72441	241	751004200	17, 21
70521	305	71453	133	72224	246	72442	241	753000700	21
70522	305	71454	133	72226	246	72443	241	762955300	73
70523	305	71470	133	72227	246	72444	241	762955700	73
70527	304	71975	228	72228	246	72451	241	766004016	58
70528	304	71976	228	72229	244	72452	241	766100016	59
70529	304	71991	226	72234	244	72453	241	767050016	61
70545	310	72003	228	72250	246	72455	241	767750016	61
70548	310	72005	227	72251	246	72460	249	775004000	67, 69
70571	309	72016	228, 234	72261	244	72461	249	775504100	67, 69
70572	309	72071	226	72263	243	72463	249		
70573	309	72072	226	72264	243	72490	241		
70574	309	72073	226	72265	246	72494	228		
70575	309	72090	227	72266	246	72514	238		
70591	305	72095	227	72275	244	72515	238		
70592	305	72100	228, 239	72276	244	72522	249		
70593	305	72101	239	72277	244	72536	238		
70600	131	72102	239	72278	245	72538	238		
70623	333	72110	239	72284	245	72540	238		
70661	318	72111	239	72285	245	72541	238		
70665	318	72112	239	72286	245	72542	229		
70667	318	72120	239	72289	245	72559	238		
70670	331	72121	239	72295	246	72561	238		
70671	331	72130	239	72299	245	72562	238		
70672	331	72135	239	72321	243	72563	238		
70696	332	72140	239	72322	243	72638	238		
70698	332	72142	239	72324	246	72666	238		
70700	331	72150	249	72325	243	72686	230		
70710	331	72151	249	72326	246	72687	230		
70711	331	72154	244	72327	246	72688	232		
70712	331	72158	243	72328	246	72689	232		
70713	331	72159	243	72329	244	72820	251		
								8	
								80679	21
								85800	292
								87800	293
								88812	18
								88815	18
								88818	18
								88822	18
								88832	18
								89501	292
								89503	292
								842100	29
								854181	175
								854183	175
								854185	175
								854186	175
								854187	175
								854390	318
								856907	333
								856911	333
								865008700	133

No.	Page	No.	Page	No.	Page
9		FF35045	52	FF44650	49
996277400	67, 69	FF35050	52	FF44660	49
F		FF35055	52	FF44670	49
F80053	93	FF35060	52	FF44680	49
F80054	93	FF35065	52	FF44690	49
F84215	191	FF35070	52	FF44700	49
FF00025	50	FF35075	52	FF44710	49
FF00030	50	FF35080	51	FF44720	49
FF00045	50	FF35092	51	FF44730	49
FF00050	50	FF35093	51	FF44806	48
FF00055	50	FF35095	51	FF44808	48
FF00065	50	FF35120	51	FF44810	48
FF00075	50	FF35121	51	FF44812	48
FF00100	50	FF35122	51	FF44814	48
FF00110	50	FF35126	51	FF44815	48, 51
FF00120	50	FF35129	51	FF44816	48
FF00130	50	FF35130	51	FF44820	48, 51
FF00140	50	FF35136	47	FF44822	48
FF00150	50	FF35144	43, 45, 47, 53	FF44824	48
FF00160	50	FF35190	47, 51	FF44830	48
FF00200	50	FF35200	43, 45, 51	FF44835	48
FF00250	50	FF35301	41, 52	FF44840	48
FF00280	50	FF35302	41, 52	FF44850	48
FF00300	50	FF35700	41, 43, 45, 52	FF44860	48
FF00350	50	FF35710	51	FF44867	48
FF00500	50	FF35730	52	FF50007	51
FF00610	50	FF35740	51	FF50008	51
FF00612	50	FF35751	41	FF55131	52
FF00616	50	FF40056	53	FF55201	52
FF00618	50	FF40150	41, 43, 45	FF55374	53
FF00620	50	FF40165	43	FF55388	53
FF00625	50	FF40220	43, 45	FF44867	48
FF00632	50	FF40400	45, 47	FF50007	51
FF00640	50	FF44030	49	FF50008	51
FF00645	50	FF44040	49	FF55131	52
FF00650	50	FF44050	49	FF55201	52
FF00655	50	FF44060	49	FF55374	53
FF00665	50	FF44070	49	FF55388	53
FF00675	50	FF44080	49	R	
FF00680	50	FF44090	49	R17300416	291
FF00700	50	FF44100	49	R2301500	59
FF00710	50	FF44110	49	R2403200	58
FF00730	50	FF44120	49	R2403300	58
FF30030	47	FF44130	49	R2403400	58
FF30150	43	FF44140	49	R2403500	58
FF30250	45	FF44150	49	R6112500	185, 187
FF34150	43	FF44160	49	V	
FF34160	43	FF44170	49	V12102000	186
FF34200	45	FF44180	49	V12110016	186
FF34260	45	FF44200	49		
FF34500	47	FF44220	49		
FF35015	51	FF44250	49		
FF35028	41, 43, 45, 47, 52	FF44300	49		
FF35029	47	FF44620	49		
FF35040	52	FF44630	49		
		FF44640	49		

Legend

Abbreviations

Abbreviation	Description
A/S	Acetylene / Oxygen
ABS	Acrylonitrile-Butadiene-Styrene
ADR	Accord européen relatif au transport international des marchandises dangereuses par route (french)
AG	Silver
AL	Aluminium
AMS	Acetylen-Maxigas-Oxygen
AS	Non-slip
B	Petrol, Gas
BGV	Trade Associations Occupational Health and Safety Regulations
BSP	British Standard Pipe, Standard Withworth Thread as per ISO 228-1, DIN 259
BSPP	British Standard Pipe Parallel Thread, Cylindrical Pipe Thread as per ISO 7-1, EN 10226 (old DIN 2999)
BSPT	British Standard Taper Pipe Thread
BSR	Band Saw Pipe
BSW	British Standard Parallel Screw: Thread of Whitworth Form B.S.W. B.S 84
BTU	British Thermal Unit
CE	European Community
CEN	European Committee for Standardization
CFC	Chlorofluorocarbons
CFM	Cubic Feet per Minute
CFT	Constant Force Technology
CL	Channel Lock
CNC	Computerized Numerical Control
CU	Copper
DK	Pressure Class
DN	Diameter Nominal
DVGW	German Association for Gas & Water Applications
DVS	German Association for Welding
EAN	European Article Number
EPT	Enclosed Power Transmission
FE	Iron
FS	Guide Hose
G	Cylindrical External Thread, EN-ISO 228-1
GW	Gas / Water
HCFC	Hydrochlorofluorocarbons
HD	High Pressure
HFC	Hydrofluorocarbons
HFCKW	Virgin Hydro Chlorofluorocarbons
HFKW	Virgin Hydrofluorocarbons
HM	Carbide
HRC	Hardness Rockwell Cone
HSS	High Speed Steel
HZ	Hertz
IP	International Protection
ISO	International Organization for Standardization
Kcal	Kilocalorie
KSO	Capillary Gap Optimizer
L	Large
LCD	Liquid Crystal Display

Legend







Abbreviations

Abbreviation	Description
LED	Light Emitting Diode
MIM	Metal Injection Molding
MPa	Megapascals
MS	Brass
MSR/MLP	Multi-layered Composite Pipe
NM	Newton Metre
NPT	National Pipe Thread (Standard US - ASME B1.20.1)
PB	Polybutylene
PD	Power Driver
PD-E	Power Drive-Electronic
PE	Polyethylene
PEX	Cross-linked Polyethylene
PL	Plastic
PP	Polypropylene
PS	Professional
PSI	Pound-Force per Square Inch
PVC	Polyvinyl Chloride
PVDF	Polyvinylidene Fluoride
RC	RODIACUT
SAE	Society of Automotive Engineers
SD-Card	Secure Digital-memory Card
SDR	Standard Dimension Ratio
SMK	Spiral with Plastic Core
SML	Super Metal Delivery Program
SP	Standard Plier
SP	Special Performance
SPK	Standard Plastic Plier
SS	Quick Cut
SW	Spanner Size
TC	Tube Cutter
TFT	Thin-film Transistor
TiN	Titanium Nitride Coating
TPI	Bits per Inch
TRGI	Technical Guidelines for Gas Installations
TRWI	Technical Guidelines for Water Installations
TÜV	Technical Inspection Association
UKS	Orbital Circular Saw
UNC	Unified Coarse Threads
UNF	Unified Fine Thread
VA (Stahl)	Stainless Steel, Corrosion Resistant Steel
VCR	Video Cassette Recording
VDE	Registered Association of the Electrical, Electronic and Information Technology
VPE	Packaging Unit
WG	Hot Gas
ZN	Zinc
ZPZ	Bits per Inch
ZVSHK	German Central Association Plumbing, Heating and Air Conditioning














Legend

Pictograms















































Power supply

 AC 230 V	 AC 115 V	 AC 110 V	 Three-phase current 400 V	 Battery-powered	 Cable length 5 m
 Battery + AC operation possible	 Battery operation	 Battery charger	 Cordless Alliance System ¹⁾		

Miscellaneous

 Can be used overhead	 Can be used in confined spaces	 Suitable for tight spaces	 Basic soft soldering up to 450 °C	 Hot brazing 450 ° - 1100 °C	 Max autogen welding 1100 °C
 Fast cut	 No deformation from use	 Dry drilling	 Wet drilling	 Up to 50% time-saving	 Portable operation
 360° rotatable	 Fine adjustment of the flame				

Product features

 Ergonomic design	 Meets DIN standards	 VDE approved	 Propane control	 Oxygen control	 Acetylene control
 Shock absorption	 On / off switch	 LED display	 Sturdy casing	 Extension of hose possible	 Piezo ignition
 Economy valve	 Pressure hose ball valve	 Inspection window	 Pressure hose length	 Emergency stop switch	 Lock button
 Bayonet coupling	 Push lock	 Thread lock	 Pressure gauge display adjustable	 Pressure gauge class 1 - 6	 Pressure gauge size
 Filling supports	 Counter display	 Balance point in handle	 Cable length	 Measuring accuracy up to g	 Scale range max. kg
 Transport case	 Heed safety warning	 Heed industrial safety	 Touchscreen	 With USB connection	 With video function
 With photo function	 Memory card	 WiFi	 RO SERVICE Case system	 DURA LAZR TEC Laser hardening process	 5-Year-EXCHANGE GUARANTEE ²⁾
 eTOOL (NFC tag)	 ROBOX Sorting system	 Product apps for Android and iOS	 Eco-friendly refrigerant		

¹⁾ More information at cordless-alliance-system.com

²⁾ Detailed guarantee terms at rothenberger.com/de-de/5-jahres-umtauschgarantie

ROTHENBERGER Enclosed Power Transmission

The **EPT-Technology (Enclosed Power Transmission)** of the expander head offers the following technical benefits:

Concealed bent lever:

Protection against dirt and external mechanical damage

Energy efficient through optimised force transmission:

Ergonomic, highly optimised force flow in relation to the hand force of the user, therefore reducing effort



ROTHENBERGER Titannitrid coating

The golden **TiN Coating (Titannitrid-coating)** of the expander head offers the following technical benefits:

High durability 2,300 HV:

Protection against abrasive wear

Lower friction value compared to steel:

Less effort

Good chemical resistance:

Good protection against corrosion

Universal wear resistance:

Long-lasting



ROTHENBERGER Constant Force Technology

The **CFT (Constant Force Technology)** guarantees a constant axial pressing force over the entire service interval. A very important requirement for the production of sealed press connections CFT guarantees:

ROMAX Compact TT

19 kN for 40,000 press cycles

ROMAX AC ECO

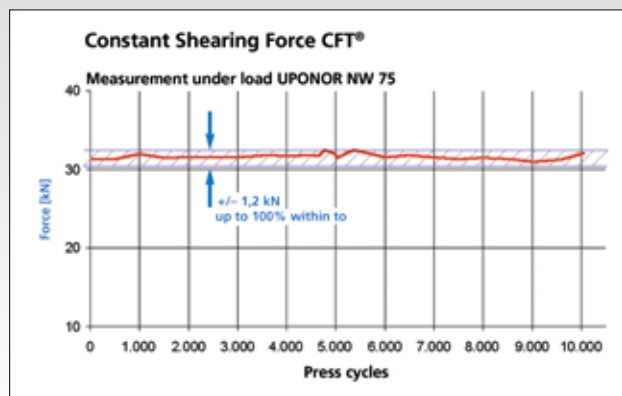
32 kN for 10,000 press cycles

ROMAX 4000

32 kN for 40,000 press cycles

ROMAX 3000 AC

32 kN for 20,000 press cycles



ROTHENBERGER DURAMAG Technology

The **DURAMAG Technology (High Tec Magnesium Body)** offers the following benefits:

- Improved performance
- Higher stability with considerably lower weight

DURA = Durable MAG = Magnesium



Packaging units





Imprint

This catalog is a publication of

ROTHENBERGER Werkzeuge GmbH

Industriestraße 7
65779 Kelkheim (Taunus)

Germany

Phone +49 6195 800-0

Fax +49 6195 800-3500

info@rothenberger.com

Company register and number: Königstein / Taunus, HRB 2732

Great care was taken in compiling this catalog and reproduction of the product information. Nevertheless we cannot completely exclude the possibility of error. For this reason, ROTHENBERGER disclaims any liability for any errors which may have arisen despite careful checking of the contents.

The design, compilations, performance data, features, dimensions and weight of products can alter as a result of further technical developments and adaptation of our products to the requirements and wishes of our customers, without any duty on our part to announce this in advance.

We are not obliged to alter already delivered products to match such new developments. We also reserve the right to remove articles from our product programme.

This catalog invalidates all previous versions. Standard specifications are non-binding. The operating instructions and suggestions for use and safety are non-binding and do not in any way replace legal or other regulations, such as employer's liability insurance association regulations, in the respective countries.

No part of this catalog may be reproduced in any way whether by reprinting, photocopying, putting onto microfilm or any other process, or be converted into a machine-readable language or stored in any electronic systems and processed there without prior written permission from ROTHENBERGER Werkzeuge GmbH.

It is not permitted to make any changes and additions to the catalog. We reserve all rights for all countries.

© 2021 ROTHENBERGER Werkzeuge GmbH, Germany



ROTHENBERGER
pipetool technologies at work



We connect people
with water and energy.
Safe. Sustainable.

